

# Seltos

Owner's Manual

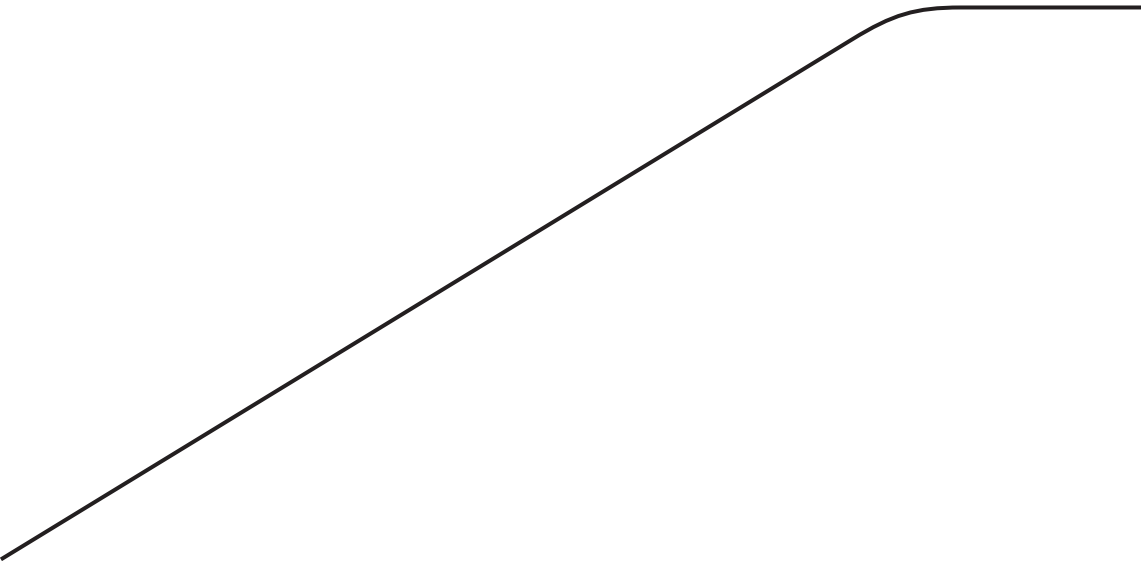

Movement that inspires

## FOREWORD

Dear Customer,

Thank you for selecting your new Kia vehicle.

As a global car manufacturer focused on building high-quality vehicles with exceptional value, Kia is dedicated to providing you with a customer service experience that exceeds your expectations.

This Owner's Manual is valid for all variants of your model, and describes all options, features, and equipment available, along with the maintenance needs. Therefore, this manual may also describe optional equipment not purchased on your vehicle, country specifications, and functions and features not available in your region. Please always keep this manual in the vehicle for your and any subsequent owner's reference.

Authorised Kia Dealerships provide factory-trained technicians, utilized recommended special tools, and supply genuine Kia replacement parts to help you maintain and service your vehicle during your ownership.

All information contained in this Owner's Manual was accurate at the time of publication. However, as Kia continues to make improvements to its products, the company reserves the right to make changes to this manual or any of its vehicles at any time without notice and without incurring any obligations.

Please drive safely, and enjoy your Kia vehicle!

© 2024 Kia India Private Limited

All rights reserved. May not be reproduced or translated in whole or in part without the written consent of Kia India Private Limited

Printed in India

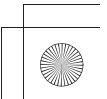
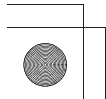
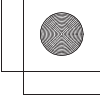
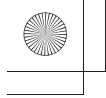

## How to use this manual

We want to help you get the greatest possible driving pleasure from your vehicle. Your Owner's Manual can assist you in many ways.

We strongly recommend that you read the entire manual. In order to minimise the chance of death or injury, you must read the WARNING and CAUTION sections in the manual.

Illustrations complement the words in this manual to best explain how to enjoy your vehicle. By reading your manual, you learn about features, important safety information, and driving tips under various road conditions.

The general layout of the manual is provided in the Table of Contents. Use the index when looking for a specific area or subject, it has an alphabetical listing of all information in your manual.

**Chapters:** This manual has nine chapters plus an index. Each chapter begins with a brief list of contents so you can tell at a glance if that chapter has the information you want.

You will find various WARNINGS, CAUTIONS, and NOTICES in this manual. These WARNINGS were prepared to enhance your personal safety. You should carefully read and follow ALL procedures and recommendations provided in these WARNINGS, CAUTIONS and NOTICES.

### WARNING

A WARNING indicates a situation in which harm, serious bodily injury or death could result if the warning is ignored.

### CAUTION

A CAUTION indicates a situation in which damage to your vehicle could result if the caution is ignored.

### NOTICE

A NOTICE indicates interesting or helpful information is being provided.

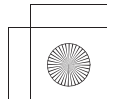
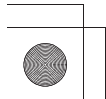
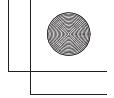
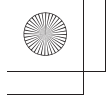

# Table of Contents

Introduction	①
Your vehicle at a glance	②
Safety features of your vehicle	③
Features of your vehicle	④
Driving your vehicle	⑤
Driver assistance system	⑥
What to do in an emergency	⑦
Maintenance	⑧
Specifications & Consumer information	⑨
Abbreviation	Ⓐ
Index	Ⓘ
Kia Warranty Policy	Ⓜ

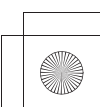
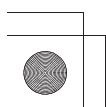
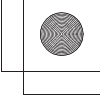
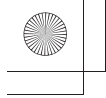

# Introduction 1

<b>Fuel requirements .....</b>	<b>1-2</b>
• Petrol engine .....	1-2
• Diesel engine .....	1-4
<b>Vehicle modifications.....</b>	<b>1-4</b>
<b>Vehicle break-in process .....</b>	<b>1-5</b>
<b>Risk of burns when parking or stopping vehicle. ....</b>	<b>1-5</b>
<b>Vehicle handling instructions .....</b>	<b>1-6</b>



## Introduction

### Fuel requirements

#### Petrol engine

##### Unleaded

Your new vehicle is designed to use only unleaded fuel having an Octane Rating of RON (Research Octane Number) 91 / AKI (Antiknock Index) 87 or higher. (Do not use methanol blended fuels)

Your new vehicle is designed to obtain maximum performance with UNLEADED FUEL, as well as minimise exhaust emissions and spark plug fouling.

##### **CAUTION**

NEVER USE LEADED FUEL. The use of leaded fuel is detrimental to the catalytic converter and will damage the engine control system's oxygen sensor and affect emission control.

Never add any fuel system cleaning agents to the fuel tank other than what has been specified. (Kia recommends to consult an authorised Kia dealer/service partner for details.)

##### **WARNING**

- Do not "top off" after the nozzle automatically shuts off when refuelling.
- Always check that the fuel cap is installed securely to prevent fuel spillage in the event of an accident.

#### Petrol containing alcohol and methanol

Gasohol, a mixture of petrol and ethanol (also known as grain alcohol), and petrol or gasohol containing methanol (also known as wood alcohol) are being mar-

keted along with or instead of leaded or unleaded petrol.

Do not use gasohol containing more than 20% ethanol, and do not use petrol or gasohol containing any methanol. Either of these fuels may cause drivability problems and damage to the fuel system, engine control system and emission control system.

Discontinue using gasohol of any kind if driveability problems occur.

Vehicle damage or driveability problems may not be covered by the manufacturer's warranty if they result from the use of:

1. Gasohol containing more than 20% ethanol.
2. Petrol or gasohol containing methanol.
3. Leaded fuel or leaded gasohol.

##### **CAUTION**

Never use gasohol which contains methanol. Discontinue use of any gasohol product which impairs drivability.

#### Other fuels

Using fuels such as

- Silicone (Si) contained fuel,
- MMT (Manganese, Mn) contained fuel,
- Ferrocene (Fe) contained fuel, and
- Other metallic additives contained fuels,

may cause vehicle and engine damage or cause plugging, misfiring, poor acceleration, engine stalling, catalyst melting, abnormal corrosion, life cycle reduction, etc.

Also, the Malfunction Indicator Lamp (MIL) may illuminate.

**\* NOTICE**

Damage to the fuel system or performance problem caused by the use of these fuels may not be covered by your New Vehicle Limited Warranty.

**Use of MTBE**

Kia recommends avoiding fuels containing MTBE (Methyl Tertiary Butyl Ether) over 15.0% vol. (Oxygen Content 2.7% weight) in your vehicle.

Fuel containing MTBE over 15.0% vol. (Oxygen Content 2.7% weight) may reduce vehicle performance and produce vapour lock or hard starting.

**⚠ CAUTION**

Your New Vehicle Limited Warranty may not cover damage to the fuel system and any performance problems that are caused by the use of fuels containing methanol or fuels containing MTBE (Methyl Tertiary Butyl Ether) over 15.0% vol. (Oxygen Content 2.7% weight.)

**Do not use methanol**

Fuels containing methanol (wood alcohol) should not be used in your vehicle. This type of fuel can reduce vehicle performance and damage components of the fuel system, engine control system and emission control system.

**Fuel additives**

Kia recommends that you use unleaded petrol which has an octane rating of RON (Research Octane Number) 91 / AKI (Antiknock Index) 87 or higher.

For customers who do not use good quality petrols including fuel additives regularly, and have problems starting or the engine does not run smoothly, one bottle of additives should be added to the fuel tank when the engine oil is replaced.

Additives are available from a professional workshop along with information on how to use them. Kia recommends to visit an authorised Kia dealer/service partner.

**Operation in foreign countries**

If you are going to drive your vehicle in another country, be sure to:

- Observe all regulations regarding registration and insurance.
- Determine that acceptable fuel is available.

1

## Diesel engine

### Diesel fuel

Diesel engines must be operated only on commercially available diesel fuel that complies with EN 590 or comparable standard. (EN stands for "European Norm"). Do not use marine diesel fuel, heating oils, or non-approved fuel additives, as this will increase wear and cause damage to the engine and fuel system. The use of non-approved fuels and / or fuel additives will result in a limitation of your warranty rights.

Diesel fuel of above cetane 51 is used in your vehicle. If two types of diesel fuels are available, use summer or winter fuel properly according to the following temperature conditions.

- Above -5 °C (23 °F) ... Summer type diesel fuel.
- Below -5 °C (23 °F) ... Winter type diesel fuel.

Watch the fuel level in the tank very carefully: If the engine stops through fuel failure, the circuits must be completely purged to restart.

## Vehicle modifications

This vehicle should not be modified.

Modification of your vehicle could affect its performance, safety or durability and may even violate governmental safety and emissions regulations. In addition, damage or performance problems resulting from any modification may not be covered under warranty.

- If you use unauthorised electronic devices, it may cause the vehicle to operate abnormally, wire damage, battery discharge and fire.

For your safety, do not use unauthorised electronic devices.

## Vehicle break-in process

By following a few simple precautions for the first 1,000 km (600 miles) you may add to the performance, economy and life of your vehicle.

- Do not race the engine.
- Whilst driving, keep your engine speed (rpm, or revolutions per minute) between 2,000 rpm and 4,000 rpm.
- Do not maintain a single speed for long periods of time, either fast or slow. Varying engine speed is needed to properly break-in the engine.
- Avoid hard stops, except in emergencies, to allow the brakes to seat properly.
- Don't tow a trailer during the first 2,000 km (1,200 miles) of operation.
- Fuel economy and engine performance may vary depending on vehicle break-in process and stabilize after 6,000 km (4,000 miles). New engines may consume more oil during the vehicle break-in period.

## Risk of burns when parking or stopping vehicle.

### WARNING

- Do not park or stop the vehicle near flammable items such as leaves, paper, oil, and tyre. Such items placed near the exhaust system can become a fire hazard.
- When an engine idles at a high speed with the rear side of the vehicle touching the wall, heat of the exhaust gas can cause discoloration or fire. Keep enough space between the rear part of the vehicle and the wall.
- Be sure not to touch the exhaust/catalytic systems whilst engine is running or right after the engine is turned off. There is a risk of burns since the systems are extremely hot.

## Vehicle handling instructions

As with other vehicles of this type, failure to operate this vehicle correctly may result in loss of control, an accident or vehicle rollover.

Specific design characteristics (higher ground clearance, track, etc.) give this vehicle a higher centre of gravity than other types of vehicles. In other words they are not designed for cornering at the same speeds as conventional 2-wheel drive vehicles.

Avoid sharp turns or abrupt manoeuvres. Again, failure to operate this vehicle correctly may result in loss of control, an accident or vehicle rollover.

Be sure to read the "Reducing the risk of a rollover" on page 5-66.

# Your vehicle at a glance **2**

Exterior overview .....	2-2
Interior overview .....	2-6
Instrument panel overview .....	2-8
Engine compartment.....	2-10

# Your vehicle at a glance

## Exterior overview

Front view



Front view (GT-Line)



OSP2IGT013001

\* The actual shape may differ from the illustration.

1. Bonnet	4-26
2. Head lamp	4-78, 8-64
3. Front fog lamp	4-80, 8-67
4. Wheel and tyre	8-39, 9-9
5. Outside rearview mirror	4-38
6. Sunroof	4-31
7. Front windscreen wiper blades	4-87, 8-35
8. Windows	4-22
9. Front ultrasonic sensors	6-93
10. Front radar	6-4
11. Roof rack	4-125



Rear view



OSP21013002

Rear view (GT-Line)



OSP2IGT013002

\* The actual shape may differ from the illustration.

1. Door outside handles	4-16
2. Fuel filler door	4-28
3. Rear combination lamp	8-60
4. High Mounted Stop Lamp	8-70
5. Tailgate	4-20
6. Antenna	4-126
7. Tailgate open switch	4-20
8. Wide-rear view camera	6-70
9. Rear ultrasonic sensors	6-89, 6-93
10. Rear window wiper	8-35

## Interior overview

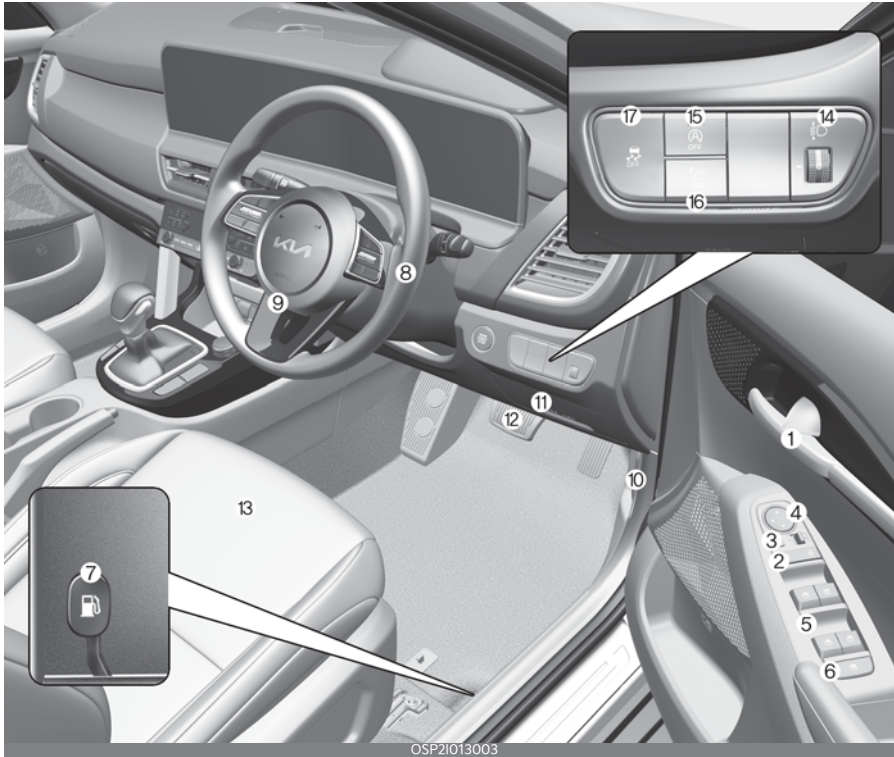

\* The actual shape may differ from the illustration.

- |   |      |
|---|------|
| 1. Inside door handle                         | 4-17 |
| 2. Central Door lock/unlock switch            | 4-18 |
| 3. Outside rearview mirror folding            | 4-40 |
| 4. Outside rearview mirror control            | 4-39 |
| 5. Power window switch                        | 4-23 |
| 6. Power window lock switch                   | 4-25 |
| 7. Fuel filler door open lever                | 4-28 |
| 8. Steering wheel                             | 4-35 |
| 9. Tilt and telescopic steering control lever | 4-36 |
| 10. Bonnet release lever                      | 4-26 |
| 11. Inner fuse panel                          | 8-52 |
| 12. Brake pedal                               | 5-39 |
| 13. Seat                                      | 3-3  |

**Your vehicle at a glance**

- 14. Headlight levelling device
- 15. ISG On/Off button
- 16. Head-Up Display shutter On/Off button
- 17. ESC Off button

**Interior overview**

- 4-84
- 5-56
- 4-76
- 5-50



## Instrument panel overview



OSP21013004

\* The actual shape may differ from the illustration.

1. Driver's front air bag	3-43
2. Horn	4-37
3. Instrument cluster	4-41
4. Light control/Turn signals lever	4-78
5. Wiper and washer control lever	4-85
6. ENGINE START/STOP button	5-9
7. Driving Assist button	4-49
8. Hazard warning flasher	7-3
9. Climate control system	4-96, 4-101
10. Shift lever	5-16, 5-19, 5-35
11. Front seat air ventilation switch	4-117
12. Parking/View button	6-70, 6-74
13. Parking Safety button	6-93

## Your vehicle at a glance

- 14. Power outlet
- 15. USB port
- 16. USB charger
- 17. Drive mode integrated control system button
- 18. USB charger
- 19. Centre console storage box
- 20. Cup holder
- 21. Glove box
- 22. Passenger's front air bag
- 23. Infotainment System
- 24. Parking brake

## Instrument panel overview

- 4-118
- 4-126
- 4-119
- 5-61
- 4-119
- 4-112
- 4-115
- 4-113
- 3-43
- 4-126
- 5-41



**2**

## Engine compartment

### Smartstream G1.5

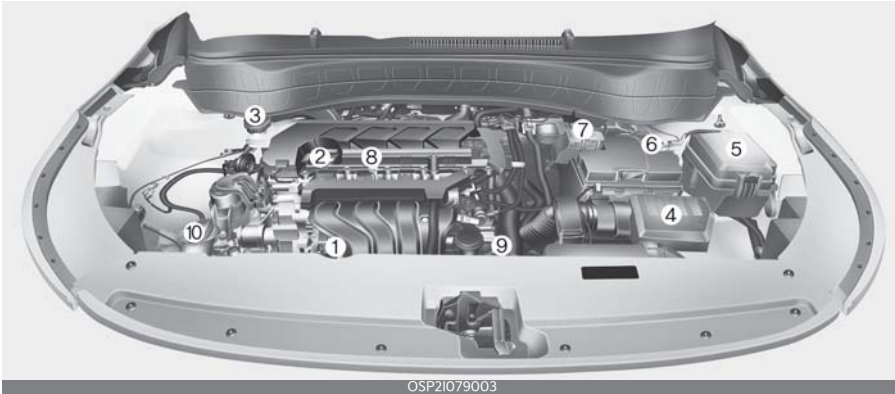

OSP21079003

\* The actual engine room in the vehicle may differ from the illustration.

1. Engine coolant reservoir	8-24
2. Engine oil filler cap	8-19
3. Brake/clutch fluid reservoir	8-28
4. Air cleaner	8-32
5. Fuse box	8-52
6. Negative battery terminal	7-5, 8-36
7. Positive battery terminal	7-5, 8-36
8. Engine oil dipstick	8-22
9. Radiator cap	7-7, 8-24
10. Windscreen washer fluid reservoir	8-29

Smartstream G1.5 T-GDi

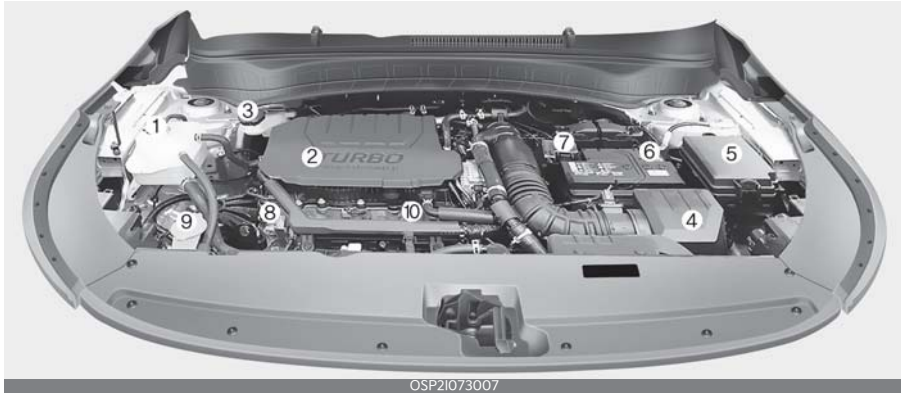

\* The actual engine room in the vehicle may differ from the illustration.

- |                                       |           |
|---------------------------------------|-----------|
| 1. Engine coolant reservoir           | 8-24      |
| 2. Engine oil filler cap              | 8-19      |
| 3. Brake/clutch fluid reservoir       | 8-28      |
| 4. Air cleaner                        | 8-32      |
| 5. Fuse box                           | 8-52      |
| 6. Negative battery terminal          | 7-5, 8-36 |
| 7. Positive battery terminal          | 7-5, 8-36 |
| 8. Engine oil dipstick                | 8-22      |
| 9. Radiator cap                       | 7-7, 8-24 |
| 10. Windscreen washer fluid reservoir | 8-29      |



(Diesel) 1.5 VGT

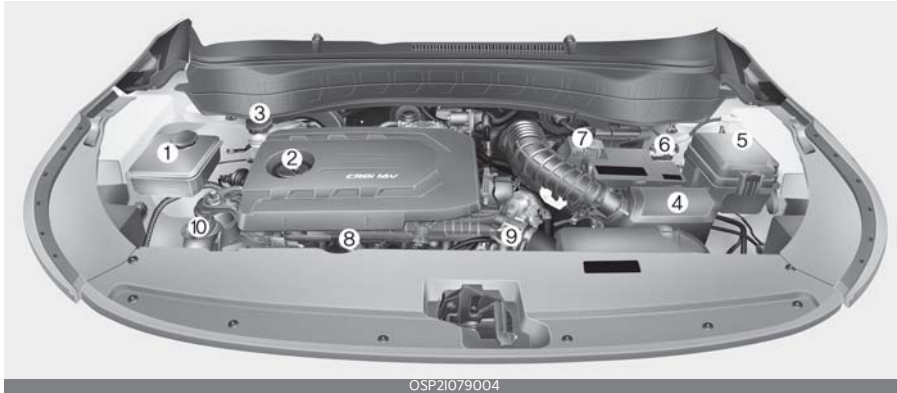

\* The actual engine room in the vehicle may differ from the illustration.

1. Engine coolant reservoir	8-24
2. Engine oil filler cap	8-22
3. Brake/clutch fluid reservoir	8-28
4. Air cleaner	8-32
5. Fuse box	8-52
6. Negative battery terminal	7-5, 8-36
7. Positive battery terminal	7-5, 8-36
8. Engine oil dipstick	8-22
9. Radiator cap	7-7, 8-24
10. Windscreen washer fluid reservoir	8-29

# Safety features of your vehicle **3**

<b>Seat</b> .....	<b>3-3</b>
• Feature of Seat Leather.....	3-5
• Front seat adjustment for manual seat.....	3-6
• Front seat adjustment for power seat.....	3-7
• Headrest (for front seat).....	3-8
• Seatback pocket.....	3-10
• Rear seat adjustment.....	3-11
• Headrest (for rear seat).....	3-14
<b>Seat belts</b> .....	<b>3-15</b>
• Seat belt restraint system.....	3-15
• Pre-tensioner seat belt.....	3-20
• Seat belt precautions.....	3-23
• Care of seat belts.....	3-25
<b>Child restraint system (CRS)</b> .....	<b>3-26</b>
• Our recommendation: Children always in the rear.....	3-26
• Selecting a Child Restraint System (CRS).....	3-26
• Installing a Child Restraint System (CRS).....	3-28
<b>ISOFIX anchorage and top-tether anchorage (ISOFIX anchorage system) for children</b> .....	<b>3-29</b>
• Securing a Child Restraint System with the "ISOFIX Anchorage System".....	3-30
• Securing a Child Restraint System seat with "Top-tether Anchorage" system.....	3-30
• To install the tether anchor:.....	3-30
• Securing a Child Restraint System with a lap/shoulder belt.....	3-31
• Suitability of each seating position for belted & ISOFIX Child Restraint Systems according to UN regulations (Information for vehicle users and CRS manufacturers) (for vehicle equipped with ISOFIX).....	3-33

# 3 Safety features of your vehicle

- Suitability of each seating position for belted & ISOFIX Child Restraint Systems according to UN regulations (Information for vehicle users and CRS manufacturers) (for vehicle without ISOFIX)..... 3-35

## **Air bag - supplemental restraint system .....3-37**

- How does the air bag system operate .....3-38
- Air bag warning and indicator..... 3-40
- SRS components and functions ..... 3-40
- Driver's and passenger's front air bag .....3-43
- Side air bag.....3-45
- Curtain air bag .....3-46
- Air bag collision sensors .....3-48
- Why didn't my air bag go off in a collision? (Inflation and non-inflation conditions of the air bag)..... 3-49
- SRS care ..... 3-52
- Additional safety precautions..... 3-53
- Adding equipment to or modifying your air bag-equipped vehicle..... 3-53
- Air bag warning label ..... 3-53

## Safety features of your vehicle

### Seat

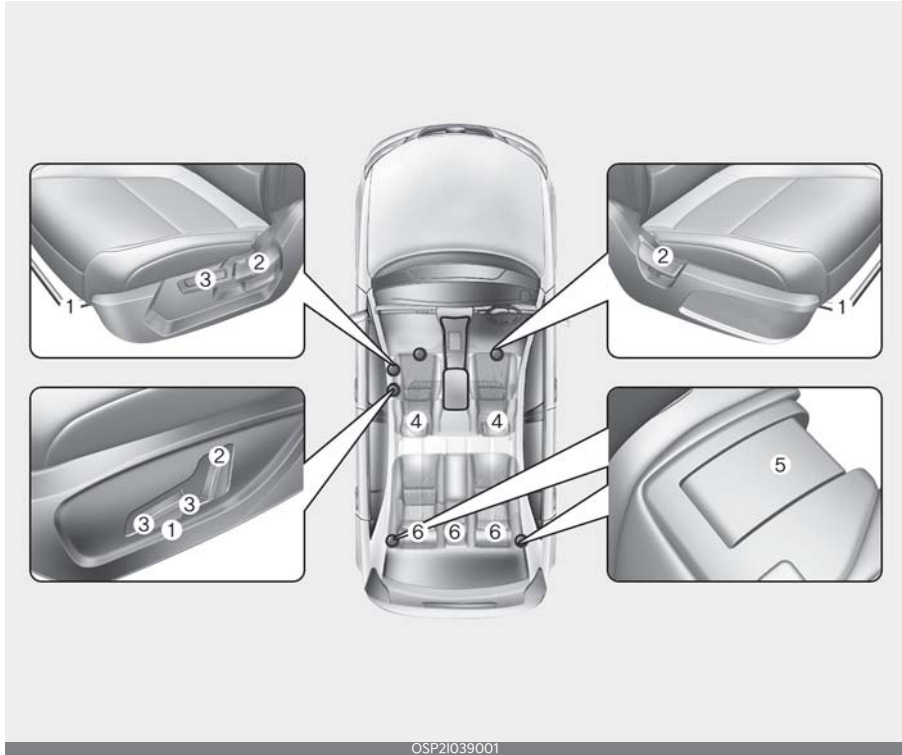

#### Front seat

1. Sliding: Forward and Backward
2. Reclining: Back angle
3. Seat cushion height\*
4. Headrest

#### Rear seat

5. Seat back folding
  6. Headrest
- \*: if equipped

**⚠ WARNING****Loose objects**

Loose objects in the driver's foot area could interfere with the operation of the foot pedals, possibly causing an accident. Do not place anything under the front seats.

**⚠ WARNING****Driver responsibility for front seat passenger**

Riding in a vehicle with a front seatback reclined could lead to serious or fatal injury in an accident. If a front seat is reclined during an accident, the occupant's hips may slide under the lap portion of the seat belt applying great force to the unprotected abdomen. Serious or fatal internal injuries could result. The driver must advise the front passenger to keep the seatback in an upright position whenever the vehicle is in motion.

**⚠ WARNING**

Do not use a sitting cushion that reduces friction between the seat and passenger. The passenger's hips may slide under the lap portion of the seat belt during an accident or a sudden stop. Serious or fatal internal injuries could result

because the seat belt can't operate normally.

**⚠ WARNING****Driver's seat**

- Never attempt to adjust seat whilst the vehicle is moving. This could result in loss of control, and an accident causing death, serious injury, or property damage.
- Do not allow anything to interfere with the normal position of the seatback. Storing items against a seatback or in any other way interfering with proper locking of a seatback could result in serious or fatal injury in a sudden stop or collision.
- Always drive and ride with your seatback upright and the lap portion of the seat belt snug and low across the hips. This is the best position to protect you in case of an accident.
- In order to avoid unnecessary and perhaps severe air bag injuries, always sit as far back as possible from the steering wheel whilst maintaining comfortable control of the vehicle. It is recommended that your chest is at least 250 mm (10 inches) away from the steering wheel.

**⚠ WARNING****Rear seatbacks**

- The rear seatback must be securely latched. If not, passengers and objects could be thrown forward resulting in serious injury or death in the event of a sudden stop or collision.
- Luggage and other cargo should be laid flat in the cargo area. If objects are large, heavy, or must be piled, they must be secured. Under no cir-

cumstances should cargo be piled higher than the seatbacks. Failure to follow these warnings could result in serious injury or death in the event of a sudden stop, collision or rollover.

- No passenger should ride in the cargo area or sit or lie on folded seatbacks whilst the vehicle is moving. All passengers must be properly seated in seats and restrained properly whilst riding.
- When resetting the seatback to the upright position, make sure it is securely latched by pushing it forward and backwards.

#### **⚠ WARNING**

After adjusting the seat, always check that it is securely locked into place by attempting to move the seat forward or backward without using the lock release lever. Sudden or unexpected movement of the driver's seat could cause you to lose control of the vehicle resulting in an accident.

#### **⚠ WARNING**

- Use extreme caution so that hands or other objects are not caught in the seat mechanisms whilst the seat is moving.
- Do not put a cigarette lighter on the floor or seat. When you operate the seat, gas may gush out of the lighter and cause fire.
- If there are occupants in the rear seats, be careful whilst adjusting the front seat position.
- Use extreme caution when picking small objects trapped under the seats or between the seat and the centre console. Your hands might be cut or

injured by the sharp edges of the seats mechanism.

#### **Feature of Seat Leather**

- Our car seats are upholstered with a combination of artificial and genuine leather. The genuine leather is made from the outer skin of an animal, which goes through a special process to be available for use. Since it is a natural substance, each part differs in thickness or density. Also, wrinkles could appear depending on the temperature and humidity.
- The seat cover is made of stretchable material to improve comfort of passengers.
- The parts contacting the body are curved and the side supporting area is high which provides driving comfort and stability.

#### **⚠ CAUTION**

- Wrinkles or abrasions which appear naturally from usage are not covered by warranty.
- Belts with metallic accessories, zippers or keys inside the back pocket may damage the seat fabric.
- Make sure not to wet the seat. It may change the nature of leather.
- Jeans or clothes which could bleach may contaminate the surface of the seat covering fabric.

### Front seat adjustment for manual seat (if equipped)

The front seat can be adjusted by using the control levers located on the outside of the seat cushion.

#### Moving forward and backward

Adjust the seat before driving, and make sure the seat is locked securely by trying to move forward and backward without using the lever. If the seat moves, it is not locked properly.

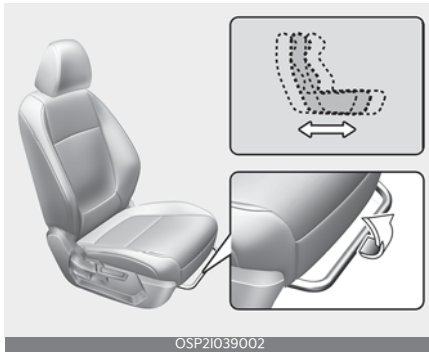

To move the seat forward or backward:

1. Pull the seat slide adjustment lever up and hold it.
2. Slide the seat to the position you desire.
3. Release the lever and make sure the seat is locked in place.

Adjust the seat before driving, and make sure the seat is locked securely by trying to move forward and backward without using the lever. If the seat moves, it is not locked properly.

### Reclining seatback



To recline the seatback:

1. Lean forward slightly and lift up the seatback recline lever.
2. Carefully lean back on the seat and adjust the seatback of the seat to the position you desire.
3. Release the lever and make sure the seatback is locked in place. (The lever **MUST** return to its original position for the seatback to lock.)

### Changing seat cushion height

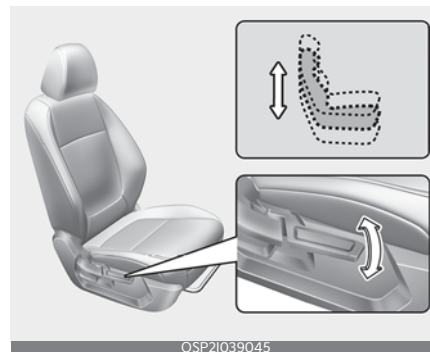

To change the height of the seat cushion, push the lever upwards or downwards.

- To lower the seat cushion, push down the lever several times.

- To raise the seat cushion, pull up the lever several times.

### Front seat adjustment for power seat (if equipped)

The driver's seat can be adjusted by using the control switches located on the outside of the seat cushion. Before driving, adjust the seat to the proper position so as to easily control the steering wheel, pedals and switches on the instrument panel.

#### **⚠ WARNING**

The power seat is operable with the ignition OFF.

Therefore, children should never be left unattended in the car.

#### **⚠ CAUTION**

- The power seat is driven by an electric motor. Stop operating once the adjustment is completed. Excessive operation may damage the electrical equipment.
- When in operation, the power seat consumes a large amount of electrical power. To prevent unnecessary charging system drain, don't adjust the power seat longer than necessary whilst the engine is not running.
- Do not operate two or more power seat control switches at the same time. Doing so may result in power seat motor or electrical component malfunction.

### Moving forward and backward

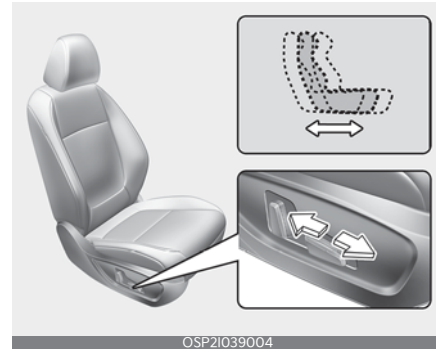

To move the seat forward or backward:

1. Push the control switch forward or rearward to move the seat to the desired position.
2. Release the switch once the seat reaches the desired position.

### Reclining seatback

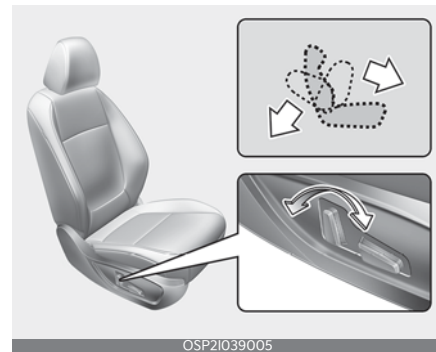

To recline the seatback:

1. Push the control switch forward or rearward to move the seatback to the desired angle.
2. Release the switch once the seat reaches the desired position.



## Changing seat cushion tilt and height (if equipped)

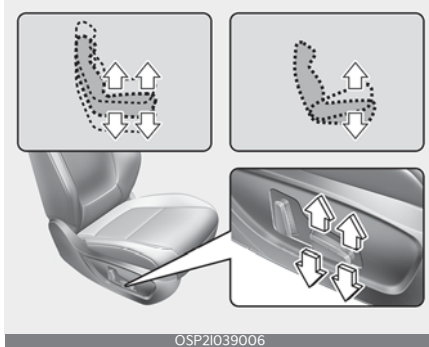

To change the height of the seat:

1. Pull the front portion of the control switch up to raise or press down to lower the front part of the seat cushion.  
Pull the rear portion of the control switch up to raise or press down to lower the seat cushion.
2. Release the switch once the seat reaches the desired position.

## Headrest (for front seat)

The driver's and front passenger's seats are equipped with a headrest for the occupant's safety and comfort.



The headrest not only provides comfort for the driver and front passenger, but also helps protect the head and neck in the event of a collision.

### ⚠ WARNING

- For maximum effectiveness in case of an accident, the headrest should be adjusted so the middle of the headrest is at the same height of the centre of gravity of an occupant's head. Generally, the centre of gravity of most people's head is similar with the height of the top of their eyes. Also, adjust the headrest as close to your head as possible. For this reason, the use of a cushion that holds the body away from the seatback is not recommended.
- Do not operate the vehicle with the headrests removed or reversed as severe injury to the occupants may occur in the event of an accident. Headrests may provide protection against neck injuries when properly adjusted.

- Do not adjust the headrest position of the driver's seat whilst the vehicle is in motion.

### Adjusting the height up and down

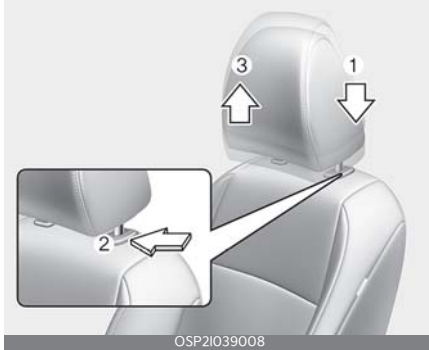

To raise the headrest:

- Pull it up to the desired position (3).
- To lower the headrest, push and hold the release button (2) on the headrest support.
- Lower the headrest to the desired position (1).

#### **⚠ WARNING**

Make sure the headrest locks in position after adjusting it to properly protect the occupants.

#### **⚠ CAUTION**

If you recline the seatback towards the front with the headrest and seat cushion raised, the headrest may come in contact with the sun visor or other parts of the vehicle.



3

### Removing headrest

#### Type A

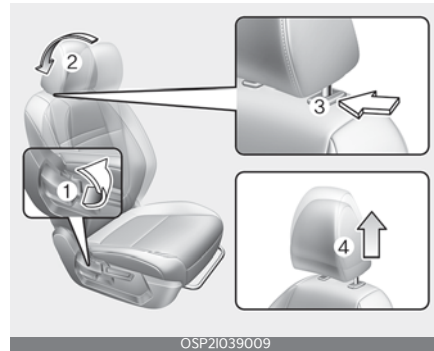

#### Type B

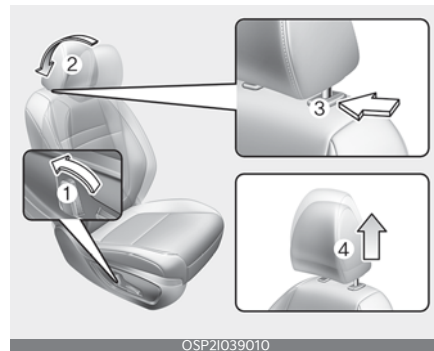

To remove the headrest:

1. Recline the seatback (2) with the recline lever or switch (1).
2. Raise headrest as far as it can go.
3. Press the headrest release button (3) whilst pulling the headrest up (4).

**⚠ WARNING**  
NEVER allow anyone to ride in a seat with the headrest removed.

### Reinstalling headrest

Type A

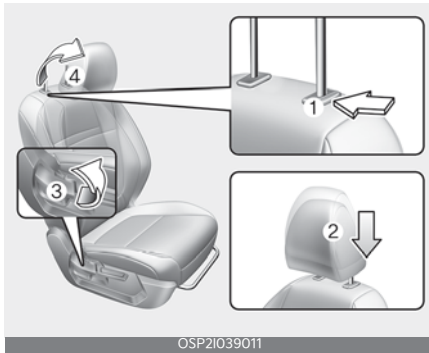

OSP21039011

Type B

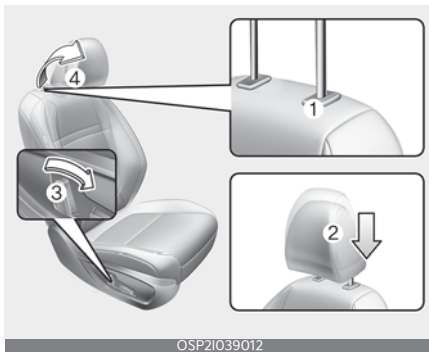

OSP21039012

To reinstall the headrest:

1. Put the headrest poles (2) into the holes whilst pressing the release button (1).

2. Recline the seatback (4) with the recline lever or switch (3).
3. Adjust the headrest to the appropriate height.

**⚠ WARNING**  
Always make sure the headrest locks into position after reinstalling and adjusting it properly.

### Seatback pocket (if equipped)

The seatback pocket is provided on the back of the front passenger's and driver's seatback.

Type A



OSP21039013

Type B



OSP21031013

**⚠ WARNING**

**Seatback pockets**

Do not put heavy or sharp objects in the seatback pockets. In an accident they could come loose from the pocket and injure vehicle occupants.

**Rear seat adjustment**

**Folding the rear seat**

The rear seatbacks can be folded to facilitate carrying long items or to increase the luggage capacity of the vehicle.

**⚠ WARNING**

The purpose of the fold-down rear seatbacks is to allow you to carry longer objects that could not be accommodated in the cargo area.

Never allow passengers to sit on top of the folded down seatback whilst the vehicle is moving. This is not a proper seating position and no seat belts are available for use. This could result in serious injury or death in case of an accident or sudden stop. Objects carried on the folded down seatback should not extend higher than the top of the front seatbacks. This could allow cargo to slide forward and cause injury or damage during sudden stops.

**To fold down the rear seatback**

1. Insert the rear seat belt buckle in the pocket between the rear seatback and cushion.



3

Then, insert the seat belt into the two holes located on both sides.

2. Set the front seatback to the upright position and if necessary, slide the front seat forward.

For rear seatback type A, take the following steps:

Type A

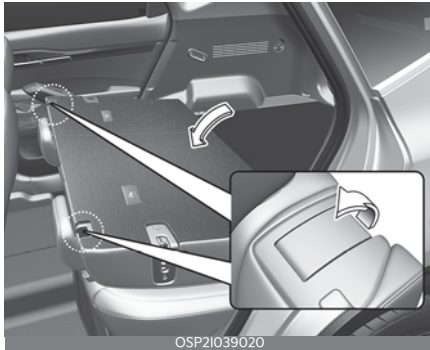

1. Lower the rear headrests to the lowest position.
2. Pull on the seatback folding lever, then fold the seat toward the front of the vehicle.

**CAUTION**

- Avoid excessive force when unfolding rear seat back.
- Unfolding the seat with excessive force may lead to lock seat back in 2nd step. This is natural phenomenon and adjust to the desired position if necessary. (applied to type 'A' only)

For rear seatback type B, take the following steps:

Type B

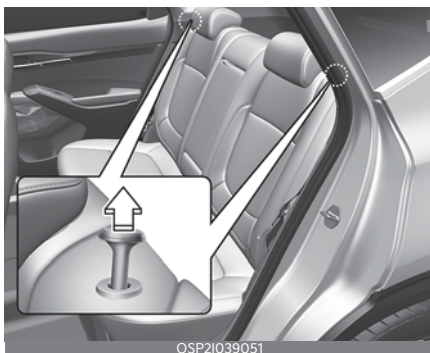

1. Pull up both sides of the seatback folding lever.
2. Fold the seat toward the front of the vehicle.

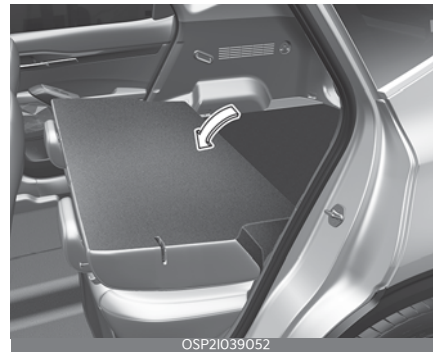

**CAUTION**

**Damaging rear seat belt buckles**

When you fold the rear seatback, insert the buckle in the pocket between the rear seatback and cushion. Doing so can prevent the buckle from being damaged by the rear seatback.

**CAUTION**

**Rear seat belts**

When returning the rear seatbacks to the upright position, remember to insert the rear shoulder belts tongue in the holder provided in Luggage side trim. This will avoid seat belt to be trapped in the back locking mechanism.

**WARNING**

**Cargo**

Cargo should always be secured to prevent it from being thrown about the vehicle in a collision and causing injury to the vehicle occupants. Do not place objects in the rear seats, since they can-

not be properly secured and may hit the front seat occupants in a collision.

**⚠ WARNING**

**Cargo loading**

Make sure the engine is off, the Automatic Transmission/Intelligent Variable Transmission is in P (Park) or the Manual Transmission/Intelligent Manual Transmission is in R (Reverse) or 1st, and the parking brake is securely applied whenever loading or unloading cargo. Failure to take these steps may allow the vehicle to move if the shift lever is inadvertently moved to another position.

**To unfold the rear seat**

**⚠ WARNING**

**Uprighting seat**

When you return the seatback to its upright position, hold the seatback and return it slowly. If the seatback is returned without holding it, the back of the seat could spring forward resulting in injury caused by being struck by the seatback.

1. Lift and pull the seatback backward and be careful not to be located the seat belt between the rear seat and vehicle body. Pull the seatback firmly until it clicks into place.

Type A



Type B



OSP21039053

2. Make sure the seatback is locked in place. When you return the seatback to its upright position, always be sure it has locked into position by pushing on the top of the seatback.  
(For type A) If you can not see the red line at the bottom of folding lever, it means the seatback is locked completely.
3. Return the rear seat belt to the proper position.
4. When the seatback is completely installed, check the seatback folding lever again.

### Headrest (for rear seat)

The rear seat(s) is equipped with headrests in all the seating positions for the occupant's safety and comfort.



OSP21039014

The headrest not only provides comfort for passengers, but also helps protect the head and neck in the event of a collision.

#### **⚠ WARNING**

- For maximum effectiveness in case of an accident, the headrest should be adjusted so the middle of the headrest is at the same height as the centre of gravity of an occupant's head. Generally, the centre of gravity of most people's head is similar with the height of the top of their eyes. Also adjust the headrest as close to your head as possible. For this reason, the use of a cushion that holds the body away from the seatback is not recommended.
- Do not operate the vehicle with the headrests removed or reversed. Severe injury to an occupant may occur in the event of an accident. Headrests may provide protection against severe neck injuries when properly adjusted.

- When there is no occupant in the rear seats, adjust the height of the headrest to the lowest position. The rear seat headrest can reduce the visibility of the rear area.

### Adjusting the height up and down (if equipped)

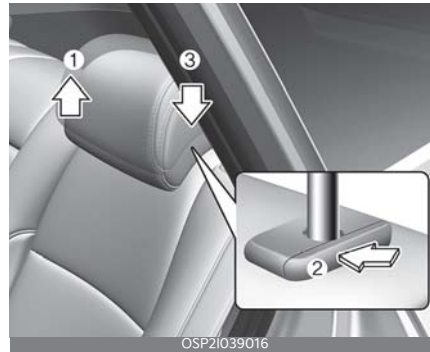

OSP21039016

- To raise the headrest, pull it up to the desired position (1).
- To lower the headrest, push and hold the release button (2) on the headrest support and lower the headrest to the desired position (3).

### Removal and installation (if equipped)

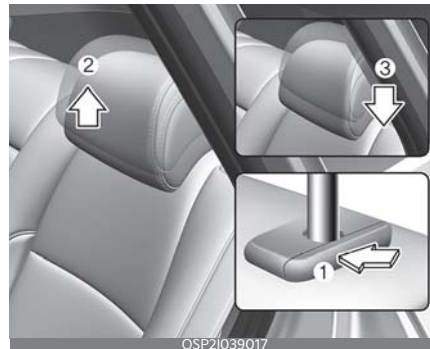

OSP21039017

- To remove the headrest, raise it as far as it can go then press the release

button (1) whilst pulling the headrest up (2).

- To reinstall the headrest, put the headrest poles (3) into the holes whilst pressing the release button (1).
- Then adjust it to the appropriate height.

#### **⚠ WARNING**

Make sure the headrest locks in position after adjusting it to properly protect the occupants.

### Armrest



To use the armrest, pull it forward from the seatback.

### Seat belts

Seat belts are designed to bear upon the bony structure of the body, and should be worn low across the front of the pelvis, chest and shoulders.

#### Seat belt restraint system

#### **⚠ WARNING**

- For maximum restraint system protection, the seat belts must always be used whenever the car is moving.
- Seat belts are most effective when seatbacks are in the upright position.
- Children age 13 and younger must always be properly restrained in the rear seat. Never allow children to ride in the front passenger seat. If a child over 13 must be seated in the front seat, he/she must be properly belted and the seat should be moved as far back as possible.
- Never wear the shoulder belt under your arm or behind your back. An improperly positioned shoulder belt can cause serious injuries in a crash. The shoulder belt should be positioned midway over your shoulder across your collarbone.
- Never wear a seat belt over fragile objects. If there is a sudden stop or impact, the seat belt can damage it.
- Avoid wearing twisted seat belts. A twisted belt can't do its job as well. In a collision, it could even cut into you. Be sure the belt webbing is straight and not twisted.
- Be careful not to damage the belt webbing or hardware. If the belt webbing or hardware is damaged, replace it.



**⚠ WARNING**

Seat belts are designed to bear upon the bony structure of the body, and should be worn low across the front of the pelvis or the pelvis, chest and shoulders, as applicable; wearing the lap section of the belt across the abdominal area must be avoided.

Seat belts should be adjusted as firmly as possible, consistent with comfort, to provide the protection for which they have been designed.

A slack belt will greatly reduce the protection afforded to the wearer.

Care should be taken to avoid contamination of the webbing with polishes, oils and chemicals, and particularly battery acid.

Cleaning may safely be carried out using mild soap and water. The belt should be replaced if webbing becomes frayed, contaminated or damaged. It is essential to replace the entire assembly after it has been worn in a severe impact even if damage to the assembly is not obvious. Belts should not be worn with straps twisted. Each belt assembly must only be used by one occupant; it is dangerous to put a belt around a child being carried on the occupant's lap.

**⚠ WARNING**

- No modifications or additions should be made by the user which will either prevent the seat belt adjusting devices from operating to remove slack, or prevent the seat belt assembly from being adjusted to remove slack.
- When you fasten the seat belt, be careful not to latch the seat belt in buckles of other seat. It's very danger-

ous and you may not be protected by the seat belt properly.

- Do not unfasten the seat belt and do not fasten and unfasten the seat belt repeatedly whilst driving. This could result in loss of control, and an accident causing death, serious injury, or property damage.
- When fastening the seat belt, make sure that the seat belt does not pass over objects that are hard or can break easily.
- Make sure there is nothing in the buckle. The seat belt may not be fastened securely.

**Seat belt warning**

ODEEV068095N

The seat belt warning light and warning chime operate under the following conditions.

**Driver's seat belt**

- Regardless of the driver's seat belt fastening, the warning light will illuminate for approximately 6 seconds each time you turn the ignition switch ON. If the driver's seat belt is not fastened, the warning chime will sound for about 6 seconds and the warning light will stay turned ON until the driver's seat belt is fastened.
- If you start to drive without the driver's seat belt fastened, when you drive under 20 km/h or stop, the warning light will illuminate. When you drive 20 km/h or faster, the warning light will blink and warning chime will sound for approximately 70 seconds.

- When the driver's seat belt is unfastened during driving, the warning light will illuminate when the speed is under 20 km/h. When the speed is 20 km/h and faster, the warning light will blink and warning chime will sound for approximately 70 seconds.

### Front Passenger's seat belt

- Regardless of the passenger's seat belt fastening, the warning light will illuminate for approximately 6 seconds each time you turn the ignition switch ON. If the passenger's seat belt is not fastened, the warning light will stay turned ON until the passenger's seat belt is fastened.
- If you start to drive without the passenger's seat belt fastened, when you drive under 20 km/h or stop, the warning light will illuminate. When you drive 20 km/h or faster, the warning light will blink and warning chime will sound for approximately 70 seconds.
- When the passenger's seat belt is unfastened during driving, the warning light will illuminate when the speed is under 20 km/h. When the speed is 20 km/h and faster, the warning light will blink and warning chime will sound for approximately 70 seconds.

### \* NOTICE

- You can find the front passenger's seat belt warning light on the cluster.
- Although the front passenger seat is not occupied, the seat belt warning light will blink or illuminate for 6 seconds.
- The front passenger's seat belt warning may operate when luggage is placed on the front passenger seat.

### Rear passenger's seat belt warning (if equipped)



\* (1) Right side, (2) Center, (3) Left side

As a reminder to the rear passenger, the rear passenger's seat belt warning lights will appear for approximately 6 seconds each time you turn the ignition switch or ENGINE START/STOP button ON regardless of belt fastening.

If the seat belt is not fastened when the ignition switch or ENGINE START/STOP button is turned ON, the seat belt warning light will appear for approximately 70 seconds.

If you start to drive without the seat belt fastened or you unfasten the seat belt when you drive under 20 km/h (12 mph), the corresponding warning light will continue to appear for approximately 70 seconds.

You unfasten the seat belt when you drive over 20 km/h (12 mph), the seat belt warning chime will sound for approximately 35 seconds and the corresponding warning light will blink.

### Fastening the seat belt:



- To fasten your seat belt, pull it out of the retractor and insert the metal tab (1) into the buckle (2). There will be an audible "click" when the tab locks into the buckle.

There will be an audible "click" when the tab locks into the buckle.

The seat belt automatically adjusts to the proper length only after the lap belt portion is adjusted manually so that it fits snugly around your hips. If you lean forward in a slow, easy motion, the belt will extend and let you move around. If there is a sudden stop or impact, however, the belt will lock into position. It will also lock if you try to lean forward too quickly.

#### \* NOTICE

If you are not able to pull out the seat belt from the retractor, firmly pull the belt out and release it. Then you will be able to pull the belt out smoothly.

#### ▲ WARNING

You should place the lap belt portion as low as possible and snugly across your hips, not on your waist. If the lap belt is located too high on your waist, it may increase the chance of injury in the

event of a collision. Both arms should not be under or over the belt. Rather, one should be over and the other under, as shown in the illustration.

Never wear the seat belt under the arm near the door.

### Releasing the seat belt:



- Press the release button (1) in the locking buckle.

When it is released, the belt should automatically draw back into the retractor.

If this does not happen, check the belt to be sure it is not twisted, then try again.

### Adjusting the height of shoulder belt (if equipped)

You can adjust the height of the shoulder belt anchor to one of 3 positions for maximum comfort and safety.

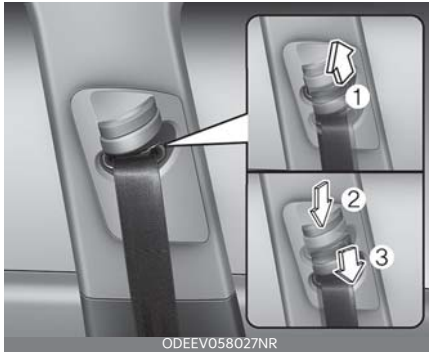

The height of the adjusting seat belt should not be too close to your neck. You will not be getting the most effective protection. The shoulder portion should be adjusted so that it lies across your chest and midway over your shoulder near the door and not your neck.

To adjust the height of the seat belt anchor, lower or raise the height adjuster into an appropriate position.

- To raise the height adjuster, pull it up (1).
- To lower it, push it down (3) whilst pressing the height adjuster button (2).

Release the button to lock the anchor into position. Try sliding the height adjuster to make sure that it has locked into position.

Improperly positioned seat belts can cause serious injuries in an accident.

**⚠ WARNING**

- Verify the shoulder belt anchor is locked into position at the appropriate height. Never position the shoulder belt across your neck or face.
- After a collision, the seat belt system should be inspected to ensure it is

operating normally. Replace any belts that are not functioning appropriately.

**Fastening the rear center seat belt (3-point type):**

1. To fasten a 3-point type belt, insert the metal tab into the locking buckle marked "CENTER". There will be an audible "click" when the tab locks into the buckle.



2. Check to make sure the belt is properly locked and that the belt is not twisted.

**Releasing the rear center seat belt (3-point type)**



- The seat belt is released by pressing the release button (1) on the locking buckle.

When it is released, the belt should automatically draw back into the retractor.

If this does not happen, check the belt to make sure it is not twisted, then try again.

### Stowing the rear seat belt

With 3-point type belt



The rear seat belt buckles can be stowed in the pocket between the rear seatback and cushion when not in use.

With 3-point type belt



The seat belt should be locked into the buckle on each seat cushion to be properly fastened.

1. Rear right seat belt fastening buckle
2. Rear center seat belt fastening buckle

### 3. Rear left seat belt fastening buckle

**WARNING**

#### 3-point type rear center seat belt



Do not separate the mini tongue (1) and mini buckle (2) even if there is not an occupant. If it is separated, it may hit the rear seat occupants in a collision or sudden stops.

### Pre-tensioner seat belt



Your vehicle is equipped with driver's and front passenger's pre-tensioner seat belts (Retractor Pre-tensioner and driver's EFD (Emergency Fastening Device)).

The purpose of the pre-tensioner is to make sure the seat belts fit tightly against the occupant's body in certain

frontal or side collision(s). The pre-tensioner seat belts may be activated in crashes where the frontal or side collision(s) is severe enough, together with the air bags.

When the vehicle stops suddenly, or if the occupant tries to lean forward too quickly, the seat belt retractor will lock into position.

In certain frontal collisions, the pre-tensioner will activate and pull the seat belt into tighter contact against the occupant's body.

- Retractor Pretensioner
  - The purpose of the retractor pretensioner is to make sure that the shoulder belts fit in tightly against the occupant's upper body in certain frontal or side collision(s).
- EFD (Emergency Fastening Device)
  - The purpose of the EFD is to make sure that the pelvis belts fit in tightly against the occupant's lower body in certain frontal or side collisions.(Driver only)
  - If the system senses excessive tension on the driver or passenger's seat belt when the pre-tensioner system activates, the load limiter inside the retractor pre-tensioner will release some of the pressure on the affected seat belt.

**⚠ WARNING**

For your safety, be sure that the belt webbing is not loose or twisted and always sit properly on your seat.

**\* NOTICE**

The pre-tensioner will activate not only in a frontal collision but also in a side col-

lision, if the vehicle is equipped with a side or curtain air bag.

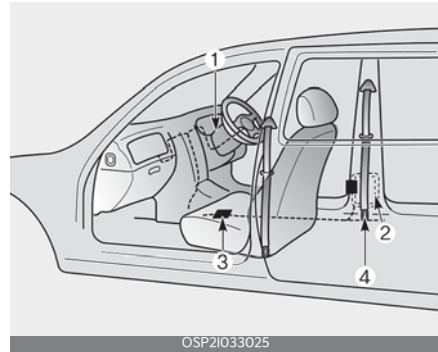

The Pre-Tensioner Seat Belt System consists mainly of the following components.

Their locations are shown in the illustration above:

1. SRS air bag warning light
2. Front retractor pre-tensioner assembly
3. SRS control module
4. Emergency fastening device(EFD) (Driver only)

**⚠ WARNING**

To obtain maximum benefit from a pre-tensioner seat belt:

1. The seatbelt must be working correctly and adjusted to the proper position. Please read and follow all of the important information and precautions about your vehicle's occupant safety features - including seat belts and air bags - that are provided in this manual.
2. Be sure you and your passengers always wear seat belts properly.

### \* NOTICE

- When the pre-tensioner seat belts are activated, a loud noise may be heard and fine dust, which may appear to be smoke, may be visible in the passenger compartment. These are normal operating conditions and are not hazardous.
- Although it is harmless, the fine dust may cause skin irritation and should not be breathed for prolonged periods. Wash all exposed skin areas thoroughly after an accident in which the pre-tensioner seat belts were activated.
- Because the sensor that activates the SRS air bag is connected with the pre-tensioner seat belt, the SRS air bag warning light on the instrument panel will illuminate for approximately 6 seconds after the ignition switch has been turned to the "ON" position, and then it should turn off.

### ▲ CAUTION

If the pre-tensioner seat belt is not working properly, the SRS air bag warning light will illuminate even if there is no malfunction of the SRS air bag. If the SRS air bag warning light does not illuminate when the ignition key is turned to ON, or if it remains illuminated after illuminating for approximately 6 seconds, or if it illuminates whilst the vehicle is being driven, have the system inspected by a professional workshop. Kia recommends to visit an authorised Kia dealer/service partner.

### ▲ WARNING

- Pre-tensioner seat belts systems are designed to operate only one time.

After activation, pre-tensioner seat belts must be replaced. All seat belts of any type should always be replaced after they have been worn during a collision.

- The pre-tensioner seat belt assembly mechanisms become hot during activation. Do not touch the pre-tensioner seat belt assemblies for several minutes after they have been activated.
- Do not attempt to inspect or replace the pre-tensioner seat belts yourself. Have the system inspected by a professional workshop. Kia recommends to visit an authorised Kia dealer/service partner.
- Do not attempt to service or repair the pre-tensioner seat belt system in any manner.
- Improper handling of the pre-tensioner seat belt assemblies, and failure to heed the warnings not to strike, modify, inspect, replace, service or repair the pre-tensioner seat belt assemblies may lead to improper operation or inadvertent activation and serious injury.
- Always wear the seat belts when driving or riding in a motor vehicle.
- If the vehicle or pre-tensioner seat belt must be discarded, contact a professional workshop. Kia recommends to visit an authorised Kia dealer/service partner.
- Body work on the front area of the vehicle may damage the pre-tensioner seat belt system. Therefore, have the system serviced by a professional workshop. Kia recommends to visit an authorised Kia dealer/service partner.

## Seat belt precautions

### WARNING

All occupants of the vehicle must wear their seat belts at all times. Seat belts and child restraints reduce the risk of serious or fatal injuries for all occupants in the event of a collision or sudden stop. Without a seat belt, occupants could be shifted too close to a deploying air bag, strike the interior structure or be thrown from the vehicle. Properly worn seat belts greatly reduce these hazards.

Always follow the precautions about seat belts, air bags and occupant seat contained in this manual.

### Infant or small child

You should be aware of the specific requirements in your country. Child and/or infant seats must be properly placed and installed in the rear seat.

For more information about the use of these restraints, refer to "Child restraint system (CRS)" on page 3-26.

### WARNING

Every person in your vehicle needs to be properly restrained at all times, including infants and children. Never hold a child in your arms or lap when riding in a vehicle. The violent forces created during a crash will tear the child from your arms and throw the child against the interior. Always use a child restraint appropriate for your child's height and weight.

### NOTICE

Small children are best protected from injury in an accident when properly restrained in the rear seat by a child restraint system that meets the require-

ments of the Safety Standards of your country. Before buying any child restraint system, make sure that it has label certifying that it meets Safety Standards of your country. The restraint must be appropriate for your child's height and weight. Check the label on the child restraint for this information. Refer to "Child restraint system (CRS)" on page 3-26.

### Larger children

Children who are too large for child restraint systems should always occupy the rear seat and use the available lap/shoulder belts. The lap portion should be fastened and snugged on the hips and as low as possible. Check if the belt fits periodically. A child's squirming could put the belt out of position. Children are afforded the most safety in the event of an accident when they are restrained by a proper restraint system in the rear seat. If a larger child (over age 13) must be seated in the front seat, the child should be securely restrained by the available lap/shoulder belt and the seat should be placed in the rearmost position. Children age 13 and under should be restrained securely in the rear seat. NEVER place a child age 13 and under in the front seat. NEVER place a rear facing child seat in the front seat of a vehicle.

If the shoulder belt portion slightly touches the child's neck or face, try placing the child closer to the centre of the vehicle. If the shoulder belt still touches their face or neck they need to be returned to a child restraint system.



**⚠ WARNING****Shoulder belts on small children**

- Never allow a shoulder belt to be in contact with a child's neck or face whilst the vehicle is in motion.
- If seat belts are not properly worn and adjusted on children, there is a risk of death or serious injury.

**Pregnant women**

OQYI033072

The use of a seat belt is recommended for pregnant women to lessen the chance of injury in an accident. When a seat belt is used, the lap belt portion should be placed as low and snugly as possible on the hips, not across the abdomen. For specific recommendations, consult a physician.

**⚠ WARNING****Pregnant women**

Pregnant women must never place the lap portion of the safety belt over the area of the abdomen where the fetus is located or above the abdomen where the belt could crush the fetus during an impact.

**Injured person**

A seat belt should be used when an injured person is being transported. When this is necessary, you should consult a physician for recommendations.

**One person per belt**

Two people (including children) should never attempt to use a single seat belt. This could increase the severity of injuries in case of an accident.

**Do not lie down**

To reduce the chance of injuries in the event of an accident and to achieve maximum effectiveness of the restraint system, all passengers should be sitting up and the front seats should be in an upright position when the car is moving. A seat belt cannot provide proper protection if the person is lying down in the rear seat or if the front seat is in a reclined position.

**⚠ WARNING**

Riding with a reclined seatback increases your chance of serious or fatal injuries in the event of a collision or sudden stop. The protection of your restraint system (seat belts and air bags) is greatly reduced by reclining your seat. Seat belts must be snug against your hips and chest to work properly. The more the seatback is reclined, the greater the chance that an occupant's hips will slide under the lap belt causing serious internal injuries or the occupant's neck could strike the shoulder belt. Drivers and passengers should always sit well back in their seats, properly belted, and with the seatbacks upright.

### Care of seat belts

Seat belt systems should never be disassembled or modified. In addition, care should be taken to assure that seat belts and belt hardware are not damaged by seat hinges, doors or other abuse.

#### WARNING

- When you return the rear seatback to its upright position after the rear seatback was folded down, be careful not to damage the seat belt webbing or buckle. Be sure that the webbing or buckle does not get caught or pinched in the rear seat. A seat belt with damaged webbing or buckle will not be as strong and could possibly fail during a collision or sudden stop, resulting in serious injury. If the webbing or buckles are damaged, get them replaced immediately.
- Seat belts can become hot in a vehicle that has been closed up in sunny weather.

They could burn infants and children.

### When to replace seat belts

Entire in-use seat belt assembly or assemblies should be replaced if the vehicle has been involved in an accident. This should be done even if no damage is visible. In this case, have the system replaced by a professional workshop. Kia recommends to consult an authorised Kia dealer/service partner.

3

### Periodic inspection

It is recommended that all seat belts be inspected periodically for wear or damage of any kind. Any damaged parts should be replaced as soon as possible.

### Keep belts clean and dry

Seat belts should be kept clean and dry. If belts become dirty, they can be cleaned by using a mild soap solution and warm water. Bleach, dye, strong detergents or abrasives should not be used because they may damage and weaken the fabric.

## Child restraint system (CRS)

### Our recommendation: Children always in the rear

#### **⚠ WARNING**

Always properly restrain children in the vehicle. Children of all ages are safer when riding in the rear seats. Never place a rearward-facing Child Restraint System on the front passenger seat, unless the air bag is deactivated.

Children under age 13 should always ride in the rear seats and must always be properly restrained to minimise the risk of injury in an accident, sudden stop or sudden manoeuvre.

According to accident statistics, children are safer when properly restrained in the rear seats than in the front seat. Children too large for a Child Restraint System must use the seat belts provided.

Most countries have regulations which require children to travel in approved Child Restraint Systems.

The laws governing the age or height/weight restrictions at which seat belts can be used instead of Child Restraint System differs among countries, so you should be aware of the specific requirements in your country, and where you are travelling.

Child Restraint Systems must be properly installed in the vehicle seat. Always use a commercially available Child Restraint System that meets the requirements of your country.

#### **Child Restraint System (CRS)**

Infants and younger children must be restrained in an appropriate rearward-facing or forward-facing CRS that has first been properly secured to the seat of

the vehicle. Read and comply with the instructions for installation and use provided by the manufacturer of the Child Restraint System.

#### **⚠ WARNING**

- Always follow the Child Restraint System manufacturer's instructions for installation and use.
- Always properly restrain your child in the Child Restraint System.
- Do not use an infant carrier or a child safety seat that "hooks" over a seat-back, it may not provide adequate protection in an accident.
- After an accident, have the system checked by a professional workshop. Kia recommends to visit an authorised Kia dealer/service partner.

### Selecting a Child Restraint System (CRS) (if equipped)

When selecting a Child Restraint System for your child, always:

- Make sure the Child Restraint System has a label certifying that it meets the applicable Safety Standards of your country.

A Child Restraint System may only be installed if it was approved in accordance with the requirements of ECE-R44 or ECE-R129.

- Select a Child Restraint System based on your child's height and weight. The required label or the instructions for use typically provide this information.
- Select a Child Restraint System that fits the vehicle seating position where it will be used.

For the suitability of Child Restraint Systems on the vehicle's seating positions, please refer to "Suitability of each seating position for belted & ISO-

FIX Child Restraint Systems according to UN regulations (Information for vehicle users and CRS manufacturers) (for vehicle equipped with ISOFIX)" on page 3-33, "Suitability of each seating position for belted & ISOFIX Child Restraint Systems according to UN regulations (Information for vehicle users and CRS manufacturers) (for vehicle without ISOFIX)" on page 3-35.

- Read and comply with the warnings and instructions for installation and use provided with the Child Restraint System.

### Child restraint system types

There are three main types of Child Restraint Systems:

- Rearward-facing CRS
- Forward-facing CRS
- Booster seat

They are classified according to the child's age, height and weight.

### Rearward-facing Child Restraint System



A rearward-facing Child Restraint System provides restraint with the seating surface against the back of the child. The harness system holds the child in place, and in an accident, acts to keep the child positioned in the Child

Restraint Systems and reduce the stress to the fragile neck and spinal cord.

All children under the age of one year must always ride in a rearward-facing Child Restraint System. There are different types of rearward-facing Child Restraint Systems: infant-only Child Restraint Systems can only be used rearward-facing. Convertible and 3-in-1 Child Restraint Systems typically have higher height and weight limits for the rearward-facing position, allowing you to keep your child rearward-facing for a longer period of time.

Keep using Child Restraint Systems in the rearward-facing position as long as children fit within the height and weight limits allowed by the Child Restraint System's manufacturer.

### Forward-facing Child Restraint System



A forward-facing Child Restraint System provides restraint for the child's body with a harness. Keep children in a forward-facing Child Restraint System with a harness until they reach the top height or weight limit allowed by your Child Restraint System's manufacturer.

Once your child outgrows the forward-facing Child Restraint System, your child is ready for a booster seat.

### Booster seats

A booster seat is a Child Restraint System designed to improve the fit of the vehicle's seat belt system. A booster seat positions the seat belt so that it fits properly over the stronger parts of your child's body. Keep your children in booster seats until they are big enough to fit in a seat belt properly.

For a seat belt to fit properly, the lap belt must lie comfortable across the upper thighs, not the stomach. The shoulder belt should lie comfortable across the shoulder and chest and not across the neck or face. Children under age 13 must always be properly restrained to minimise the risk of injury in an accident, sudden stop or sudden manoeuvre.

### Installing a Child Restraint System (CRS)

#### **⚠ WARNING**

Before installing your Child Restraint System always:

Read and follow the instructions provided by the manufacturer of the Child Restraint System.

Failure to follow all warnings and instructions could increase the risk of the SERIOUS INJURY or DEATH if an accident occurs.

#### **⚠ WARNING**

If the vehicle's headrest prevents proper installation of a Child Restraint System, the headrest of the respective seating position shall be readjusted or entirely removed.

After selecting a proper Child Restraint System for your child and checking that the Child Restraint System fits properly on the seating position, there are three general steps for a proper installation:

- **Properly secure the Child Restraint System to the vehicle.** All Child Restraint Systems must be secured to the vehicle with the lap belt or lap part of a lap/shoulder belt or with the ISO-FIX toptether and/or ISOFIX anchorage and/or with the support leg.

## ISOFIX anchorage and top-tether anchorage (ISOFIX anchorage system) for children (if equipped)

The ISOFIX system holds a Child Restraint System during driving and in an accident. This system is designed to make installation of the Child Restraint System easier and reduce the possibility of improperly installing your Child Restraint System. The ISOFIX system uses anchors in the vehicle and attachments on the Child Restraint System. The ISOFIX system eliminates the need to use seat belts to secure the Child Restraint System to the rear seats. ISOFIX anchorages are metal bars built into the vehicle. There are two lower anchors for each ISOFIX seating position that will accommodate a Child Restraint System with lower attachments.

To use the ISOFIX system in your vehicle, you must have a Child Restraint System with ISOFIX attachments.

The Child Restraint System manufacturer will provide you with instructions on how to use the Child Restraint System with its attachments for the ISOFIX anchorages.

ISOFIX anchorages have been provided in the left and right outboard rear seating positions. Their locations are shown in the illustration.

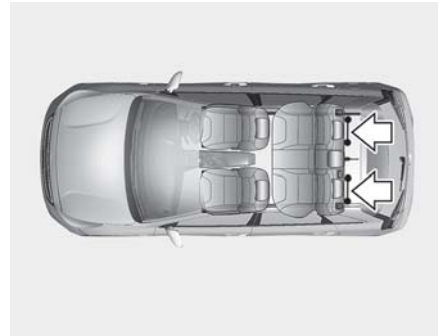

OSP2030067R

### ⚠ WARNING

Do not attempt to install a Child Restraint System using ISOFIX anchorages in the rear centre seating position. There are no ISOFIX anchorages provided for this seat. Using the outboard seat anchorages, for the CRS installation on the rear centre seating position, can damage the anchorages.

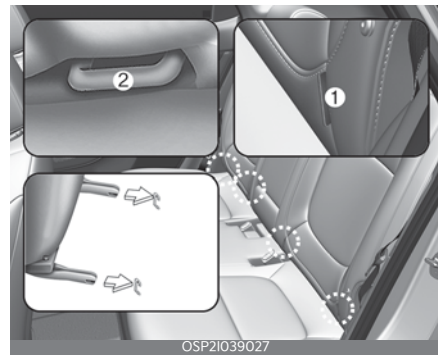

OSP21039027

1. ISOFIX Anchor Position Indicator
2. ISOFIX Anchor

ISOFIX anchorages are located between the seatback and the seat cushion of the rear seat left and right outboard seating positions, indicated by the symbols.

## Safety features of your vehicle

### Securing a Child Restraint System with the "ISOFIX Anchorage System" (if equipped)

To install a ISOFIX-compatible Child Restraint System in either of the rear outboard seating positions:

1. Move the seat belt buckle away from the ISOFIX anchorages.
2. Move any other objects away from the anchorages that could prevent a secure connection between the Child Restraint System and the ISOFIX anchorages.
3. Place the Child Restraint System on the vehicle seat, then attach the seat to the ISOFIX anchorages according to the instructions provided by the Child Restraint System manufacturer.
4. Follow the instructions of the Child Restraint System's manufacturer for proper installation and connection of the ISOFIX attachments on the Child Restraint System to the ISOFIX anchorages.

#### **⚠ WARNING**

Take the following precautions when using the ISOFIX system:

- Read and follow all installation instructions provided with your Child Restraint System.
- To prevent the child from reaching and taking hold of unretracted seat belts, buckle all unused rear seat belts and retract the seat belt webbing behind the child. Children can be strangled if a shoulder belt becomes wrapped around their neck and the seat belt tightens.
- NEVER attach more than one Child Restraint System to a single anchorage. This could cause the anchor or attachment to come loose or break.

## ISOFIX anchorage and top-tether anchorage (ISOFIX anchorage system) for children

- Always have the ISOFIX (i- Size) system inspected by your dealer after an accident. An accident can damage the ISOFIX system and may not properly secure the Child Restraint System.

### Securing a Child Restraint System seat with "Top-tether Anchorage" system (if equipped)

Child restraint system top tether anchorages are located on the back of the rear seatbacks.

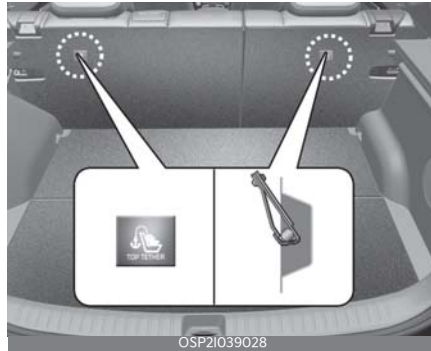

### To install the tether anchor:



1. Route the Child Restraint System top-tether strap over the seatback. Placing the top tether strap, please follow the instructions of the Child Restraint System manufacturer.

## Safety features of your vehicle

2. Connect the top-tether strap to the top-tether anchorage, then tighten the top-tether strap according to the instructions of your Child Restraint System's manufacturer to firmly attach the Child Restraint System to the seat.

### **⚠ WARNING**

Take the following precautions when installing the top-tether:

- Read and follow all installation instructions provided with your Child Restraint System.
- NEVER attach more than one Child Restraint System to a single ISOFIX top-tether anchorage. This could cause the anchorage or attachment to come loose or break.
- Do not attach the top-tether to anything other than the correct top-tether anchorage. It may not work properly if attached to something else.
- Child Restraint System anchorages are designed to withstand only those loads imposed by correctly fitted Child Restraint System.

Under no circumstances are they to be used for adult seat belts or harnesses or for attaching other items or equipment to the vehicle.

## Securing a Child Restraint System with a lap/shoulder belt

When not using the ISOFIX system, all Child Restraint Systems must be secured to a rear seat with the lap part of a lap/shoulder belt.

## ISOFIX anchorage and top-tether anchorage (ISOFIX anchorage system) for children



3

To install a Child Restraint System on the rear seats, do the following:

1. Place the Child Restraint System on a rear seat and route the lap/shoulder belt around or through the Child Restraint System, following the Child Restraint System manufacturer's instructions.

Make sure the seat belt webbing is not twisted.

2. Fasten the lap/shoulder belt latch into the buckle. Listen for the distinct "click" sound. Position the release button so that it is easy to access in case of an emergency.



3. Remove as much slack from the belt as possible by pushing down on the Child Restraint System whilst feeding



### Safety features of your vehicle

### ISOFIX anchorage and top-tether anchorage (ISOFIX anchorage system) for children

the shoulder belt back into the retractor.

4. Push and pull on the Child Restraint System to confirm that the seat belt is holding it firmly in place.

If your Child Restraint System manufacturer recommends the use of a top-tether with the lap/shoulder belt.

To remove the Child Restraint System, press the release button on the buckle and then pull the lap/shoulder belt out of the Child Restraint System and allow the seat belt to retract fully.

### Suitability of each seating position for belted & ISOFIX Child Restraint Systems according to UN regulations (Information for vehicle users and CRS manufacturers) (for vehicle equipped with ISOFIX)

- Yes: Suitable for fitment of the designated category of CRS
- No: Not suitable for fitment of the designated category of CRS
- "-": Not applicable
- The table is based on LHD vehicle. Except for the front passenger seat, the table is valid for RHD vehicle. For RHD vehicle front passenger seat, please use information for the seating position number 3.

F: Forward facing  
R: Rearward facing

CRS categories		Seating positions					
		1, 2	3		4	5	6
			POWER	MANUAL			
Universal belted CRS		-	No	No	Yes F, R	Yes F, R <sup>1</sup>	Yes F, R
i-Size CRS (with support leg)	ISOFIX (F2,F2X,R1,R2)	-	No	No	No	No	No
ISOFIX infant CRS (i.e., CRS for a baby)	ISOFIX (R1)	-	No	No	Yes R	No	Yes R
Carry cot (ISOFIX lateral facing CRS)	ISOFIX (L1,L2)	-	No	No	No	No	No
ISOFIX toddler CRS - small	ISOFIX (F2,F2X, R2)	-	No	No	Yes F, R	No	Yes F, R
ISOFIX toddler CRS - large* (*: not booster seats)	ISOFIX (F3, R3)	-	No	No	Yes F, R <sup>2</sup>	No	Yes F, R <sup>2</sup>
Booster seat-Reduced width	ISO/B2	-	No	No	Yes	No	Yes
Booster seat-Full width	ISO/B3	-	No	No	Yes	No	Yes

- \* 1: Rearward facing CRS is only available with a 3-pt belt option
- \* 2: For fitment of ISOFIX toddler's rearward facing large CRS
  - Driver's seat: Seat pumping should be adjusted to appropriate height.
  - Front passenger seat: Seat sliding should be adjusted to appropriate position.
- \* Never place a rearward facing Child Restraint System on the front passenger seat, unless the passenger air bag is deactivated.
- \* It is recommended to remove the head restraint, when CRS is unstable due to head restraint.



3

Safety features of your vehicle

ISOFIX anchorage and top-tether anchorage (ISOFIX anchorage system) for children



Seat Number	Position in the vehicle
1	Front right
2	Front centre
3	Front left
4	2nd row left
5	2nd row centre
6	2nd row right

### Suitability of each seating position for belted & ISOFIX Child Restraint Systems according to UN regulations (Information for vehicle users and CRS manufacturers) (for vehicle without ISOFIX)

- Yes: Suitable for fitment of the designated category of CRS
- No: Not suitable for fitment of the designated category of CRS
- "-": Not applicable
- The table is based on LHD vehicle. Except for the front passenger seat, the table is valid for RHD vehicle. For RHD vehicle front passenger seat, please use information for the seating position number 3.

F: Forward facing

R: Rearward facing

CRS categories		Seating positions					
		1, 2	3		4	5	6
			Power	Manual			
Universal belted CRS		-	No	No	Yes F, R	Yes F, R <sup>1</sup>	Yes F, R
i-Size CRS (with support leg)	ISOFIX (F2,F2X,R1,R2)	-	No	No	No	No	No
ISOFIX infant CRS (i.e., CRS for a baby)	ISOFIX (R1)	-	No	No	No	No	No
Carry cot (ISOFIX lateral facing CRS)	ISOFIX (L1,L2)	-	No	No	No	No	No
ISOFIX toddler CRS - small	ISOFIX (F2,F2X, R2)	-	No	No	No	No	No
ISOFIX toddler CRS - large* (*: not booster seats)	ISOFIX (F3, R3)	-	No	No	No	No	No
Booster seat-Reduced width	ISO/B2	-	No	No	No	No	No
Booster seat-Full width	ISO/B3	-	No	No	No	No	No

\* 1: Rearward facing CRS is only available with a 3-pt belt option

\* Never place a rearward facing Child Restraint System on the front passenger seat, unless the passenger air bag is deactivated.

\* It is recommended to remove the head restraint, when CRS is unstable due to head restraint.



3

## Safety features of your vehicle

## ISOFIX anchorage and top-tether anchorage (ISOFIX anchorage system) for children



Seat Number	Position in the vehicle
1	Front right
2	Front centre
3	Front left
4	2nd row left
5	2nd row centre
6	2nd row right

## Air bag - supplemental restraint system

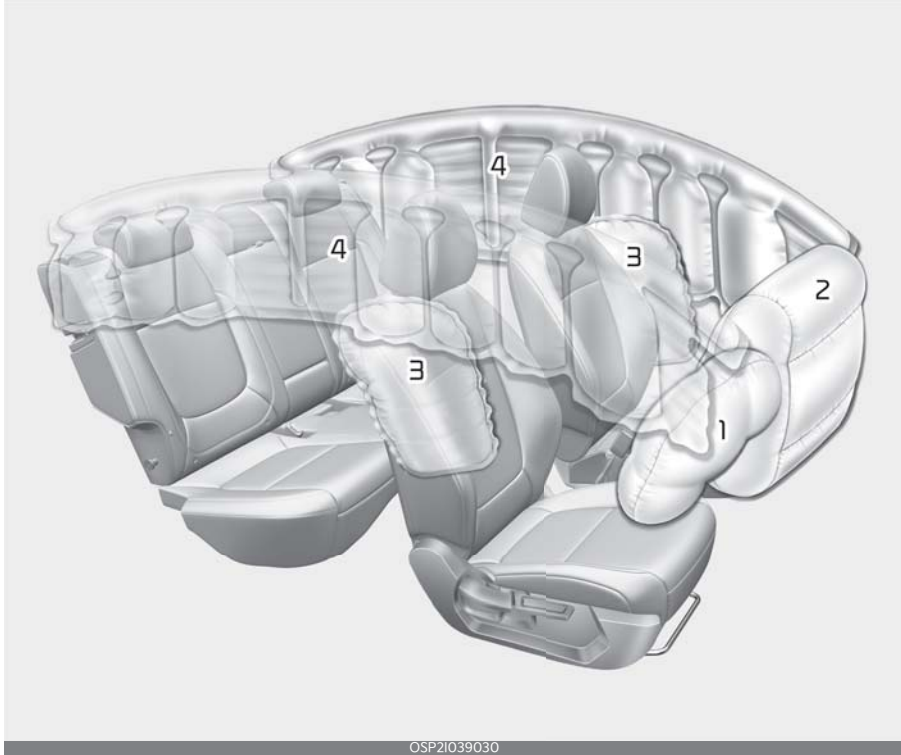

OSP21039030

\* The actual air bags in the vehicle may differ from the illustration.

1. Driver's front air bag
2. Passenger's front air bag
3. Side air bag
4. Curtain air bag

**⚠ WARNING**

- Even in vehicles with air bags, you and your passengers must always wear the safety belts provided in order to minimise the risk and severity of injury in the event of a collision or in most rollover situations.
- SRS and pre-tensioners contain explosive chemicals.  
If scraping a vehicle without removing SRS and pre-tensioners from a vehicle, it may cause fire. Before scraping a vehicle, contact a professional workshop. Kia recommends to visit an authorised Kia dealer/service partner.
- Keep the SRS parts and wirings away from water or any liquid. If the SRS components are inoperative due to exposure to water or liquids, it may cause fire or severe injury.

**How does the air bag system operate**

- Air bags are activated (able to inflate if necessary) only when the ignition switch is turned to the ON or START position.
- Air bags inflate instantly in the event of serious frontal or side collision (if equipped with side air bag or curtain air bag) in order to help protect the occupants from serious physical injury.
- There is no single speed at which the air bags will inflate.  
Generally, air bags are designed to inflate based upon the severity of a collision and its direction. These two factors determine whether the sensors produce an electronic deployment/inflation signal.

- Air bag deployment depends on a number of factors including vehicle speed, angles of impact and the density and stiffness of the vehicles or objects which your vehicle hits in the collision. The determining factors are not limited to those mentioned above.
- The front air bags will completely inflate and deflate in an instant.  
It is virtually impossible for you to see the air bags inflate during an accident. It is much more likely that you will simply see the deflated air bags hanging out of their storage compartments after the collision.
- In order to help provide protection in a severe collision, the air bags must inflate rapidly. The speed of air bag inflation is a consequence of extremely short time in which a collision occurs and the need to get the air bag between the occupant and the vehicle structures before the occupant impacts those structures. This speed of inflation reduces the risk of serious or life-threatening injuries in a severe collision and is thus a necessary part of air bag design.
- However, air bag inflation can also cause injuries which can include facial abrasions, bruises and broken bones because the inflation speed also causes the air bags to expand with a great deal of force.
- **There are even circumstances under which contact with the steering wheel air bag can cause fatal injuries, especially if the occupant is positioned excessively close to the steering wheel.**

**⚠ WARNING**

- To avoid severe personal injury or death caused by deploying air bags in

a collision, the driver should sit as far back from the steering wheel air bag. The front passenger should always move their seat as far back as possible and sit back in their seat.

- Air bag inflates instantly in an event of a collision, passengers may be injured by the air bag expansion force if they are not in a proper position.
- Air bag inflation may cause injuries including facial or bodily abrasions, injuries from broken glasses or burns.

### Noise and smoke

When the air bags inflate, they make a loud noise and they leave smoke and powder in the air inside of the vehicle. This is normal and is a result of the ignition of the air bag inflator. After the air bag inflates, you may feel substantial discomfort in breathing due to the contact of your chest with both the seat belt and the air bag, as well as from breathing the smoke and powder. **Open your doors and/or windows as soon as possible after impact in order to reduce discomfort and prevent prolonged exposure to the smoke and powder.** Though smoke and powder are non-toxic, it may cause irritation to the skin (eyes, nose and throat, etc.). If this is the case, wash and rinse with cold water immediately and consult the doctor if the symptom persists.

#### **⚠ WARNING**

- When the air bags deploy, the air bag related parts in the steering wheel and/or instrument panel and/or in both sides of the roof rails above the front and rear doors are very hot. To prevent injury, do not touch the air bag storage areas internal compo-

nents immediately after an air bag has inflated.

- Do not install or place any accessories near air bag deployment areas, such as the instrument panel, windows, pillars, and roof rails.

### Front passenger's air bag warning label for child restraint system



#### **⚠ WARNING**

Never place a rearward facing child restraint in the front passenger seat, unless the passenger-side air bag is deactivated. An inflating passenger-side air bag could impact the rearward facing child restraint and kill the child.

In addition, we recommend that you do not place front-facing child restraints in the front passenger's seat either. If the front passenger air bag inflates, it could cause serious or fatal injuries to the child.

If your vehicle is equipped with the passenger's front air bag ON/OFF switch, you can activate or deactivate the front passenger's air bag when necessary. For more details, please refer to "Child restraint system (CRS)" on page 3-26. (if equipped)



**⚠ WARNING**

- NEVER use a rearward facing child restraint on a seat protected by an ACTIVE AIR BAG in front of it. DEATH or SERIOUS INJURY to the CHILD can occur.
- When children are seated in the rear outboard seats of a vehicle equipped with side and/or curtain air bags, be sure to install the child restraint system as far away from the door side as possible, and securely lock the child restraint system in position.  
Inflation of side and/or curtain air bags could cause serious injury or death to an infant or child.

**Air bag warning and indicator**

**Air bag warning light**

The purpose of the air bag warning light in your instrument panel is to alert you of a potential problem with your air bag - Supplemental Restraint System (SRS).



When the ignition switch is turned ON, the warning light should illuminate for approximately 6 seconds, then go off. Have the system checked if:

- The light does not turn on briefly when you turn the ignition ON.
- The light stays on after illuminating for approximately 6 seconds.
- The light comes on whilst the vehicle is in motion.
- The light blinks when the ignition switch is in ON position.

**SRS components and functions**

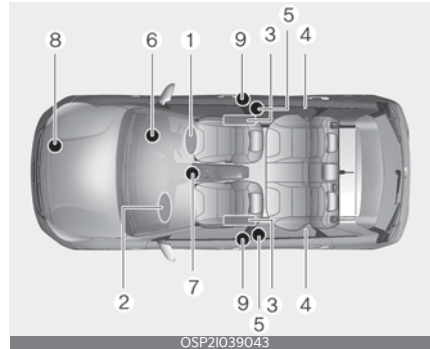

\* The actual position of SRS components may differ from the illustration.

The SRS consists of the following components:

1. Driver's front air bag module
2. Passenger's front air bag module
3. Side air bag modules
4. Curtain air bag modules\*
5. Retractor pre-tensioner assemblies
6. Air bag warning light
7. SRS control module (SRSCM)
8. Front impact sensor
9. Side impact sensors\*

\*: if equipped

The SRSCM continually monitors all elements whilst the ignition switch is ON to determine if a frontal, near-frontal impact or side impact is severe enough to require air bag deployment or pre-tensioner seat belt deployment.

The SRS air bag warning light on the instrument panel will illuminate for about 6 seconds after the ignition switch is turned to the ON position, after which the air bag warning light should go out.

## Safety features of your vehicle

### **⚠ WARNING**

If any of the following conditions occurs, this indicates a malfunction of the SRS. In this case, have the system inspected by a professional workshop. Kia recommends to visit an authorised Kia dealer/ service partner.

- The light does not turn on briefly when you turn the ignition ON.
- The light stays on after illuminating for approximately 6 seconds.
- The light comes on whilst the vehicle is in motion.
- The light blinks when the ignition switch is in ON position.

Driver's front air bag (1)



The air bag modules are located both in the centre of the steering wheel and in the front passenger's panel above the glove box. When the SRSCM detects a sufficiently severe impact to the front of the vehicle, it will automatically deploy the front air bags.

## Air bag - supplemental restraint system

Driver's front air bag (2)



Upon deployment, tear seams molded directly into the pad covers will separate under pressure from the expansion of the air bags. Further opening of the covers then allows full inflation of the air bags.

Driver's front air bag (3)



A fully inflated air bag, in combination with a properly worn seat belt, slows the driver's or the passenger's forward motion, reducing the risk of head and chest injury.

After complete inflation, the air bag immediately starts deflating, enabling the driver to maintain forward visibility and the ability to steer or operate other controls.

3

Passenger's front air bag



OYB030093R

**WARNING**

- Do not install or place any accessories (drink holder, CD holder, sticker, etc.) on the front passenger's panel above the glove box in a vehicle with a passenger's air bag. Such objects may become dangerous projectiles and cause injury if the passenger's air bag inflates.
- When installing a container of liquid air freshener inside the vehicle, do not place it near the instrument cluster nor on the instrument panel surface. It may become dangerous projectiles and cause injury if the passenger's air bag inflates.

**WARNING**

- If an air bag deploys, there may be a loud noise followed by a fine dust released in the vehicle. These conditions are normal and are not hazardous - the air bags are packed in this fine powder. The dust generated during air bag deployment may cause skin or eye irritation as well as aggravate asthma for some persons. Always wash all exposed skin areas thoroughly with cold water and a mild

soap after an accident in which the air bags were deployed.

- The SRS can function only when the ignition key is in the ON position. If the SRS air bag warning light does not illuminate, or continuously remains on after illuminating for about 6 seconds when the ignition key is turned to the ON position, or after the engine is started, comes on whilst driving, the SRS is not working properly. In this case, have the system inspected by a professional workshop. Kia recommends to visit an authorised Kia dealer/service partner.
- Before you replace a fuse or disconnect a battery terminal, turn the ignition switch to the LOCK position and remove the ignition key or turn off the ENGINE START/STOP button. Never remove or replace the air bag related fuse(s) when the ignition switch is in the ON position. Failure to heed this warning will cause the SRS air bag warning light to illuminate.

## Driver's and passenger's front air bag

Driver's front air bag



OSP21033072

Passenger's front air bag



OSP21033034

Your vehicle is equipped with a Supplemental Restraint (Air Bag) System and lap/shoulder belts at both the driver and passenger seating positions.

The indications of the system's presence are the letters "AIR BAG" intagliated on the air bag pad cover in the steering wheel and the passenger's side front panel pad above the glove box.

The SRS consists of air bags installed under the pad covers in the centre of the steering wheel and the passenger's side front panel above the glove box.

The purpose of the SRS is to provide the vehicle's driver and/or the front passenger with additional protection than that offered by the seat belt system alone in case of a frontal impact of sufficient severity.

### ⚠ WARNING

The driver's hands should be placed on the steering wheel at the 9:00 and 3:00 positions. The passenger's arms and hands should be placed on their laps.

### ⚠ WARNING

Always use seat belts and child restraints - every trip, every time, every-one! Air bags inflate with considerable force and in the blink of an eye. Seat belts help keep occupants in proper position to obtain maximum benefit from the air bag. Even with air bags, improperly and unbelted occupants can be severely injured when the air bag inflates. Always follow the precautions about seat belts, air bags and occupant safety contained in this manual.

To reduce the chance of serious or fatal injuries and receive the maximum safety benefit from your restraint system:

- Never place a child in any child or booster seat in the front seat.
- ABC - Always Buckle Children in the back seat. It is the safest place for children of any age to ride.
- Front and side air bags can injure occupants improperly positioned in the front seats.
- Move your seat as far back as practical from the front air bags, whilst still maintaining control of the vehicle.
- You and your passengers should never sit or lean unnecessarily close to the air bags. Improperly positioned

- drivers and passengers can be severely injured by inflating air bags.
- Never lean against the door or centre console - always sit in an upright position.
  - No objects should be placed over or near the air bag modules on the steering wheel, instrument panel, and the front passenger's panel above the glove box, because any such object could cause harm if the vehicle is in a crash severe enough to cause the air bags to deploy.
  - Do not tamper with or disconnect SRS wiring or other components of the SRS system. Doing so could result in injury, due to accidental deployment of the air bags or by rendering the SRS inoperative.
  - If the SRS air bag warning light remains illuminated whilst the vehicle is being driven, have the system inspected by a professional workshop. Kia recommends to visit an authorised Kia dealer/service partner.
  - Air bags can only be used once - have the system replaced by a professional workshop. Kia recommends to visit an authorised Kia dealer/service partner.
  - The SRS is designed to deploy the front air bags only when an impact is sufficiently severe and when the impact angle is less than 30° from the forward longitudinal axis of the vehicle. Additionally, the air bags will only deploy once. Seat belts must be worn at all times.
  - Front air bags are not intended to deploy in side-impact, rear-impact or rollover crashes. In addition, front air bags will not deploy in frontal crashes below the deployment threshold.
  - A child restraint system must never be placed in the front seat. The infant or child could be severely injured or killed by an air bag deployment in case of an accident.
  - Children age 13 and under must always be properly restrained in the rear seat. Never allow children to ride in the front passenger seat. If a child over age 13 must be seated in the front seat, he or she must be properly belted and the seat should be moved as far back as possible.
  - For maximum safety protection in all types of crashes, all occupants including the driver should always wear their seat belts whether or not an air bag is also provided at their seating position to minimise the risk of severe injury or death in the event of a crash. Do not sit or lean unnecessarily close to the air bag whilst the vehicle is in motion.
  - Sitting improperly or out of position can result in serious or fatal injury in a crash. All occupants should sit upright with the seat back in an upright position, centred on the seat cushion with their seat belt on, legs comfortably extended and their feet on the floor until the vehicle is parked and the ignition key is removed.
  - The SRS air bag system must deploy very rapidly to provide protection in a crash. If an occupant is out of position because of not wearing a seat belt, the air bag may forcefully contact the occupant causing serious or fatal injuries.

### Side air bag

Your vehicle is equipped with a side air bag in each front seat.



OSP21039035

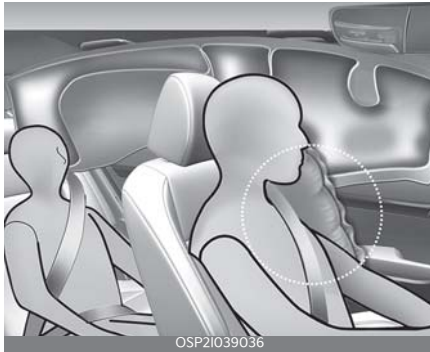

OSP21039036

\* The actual air bags in the vehicle may differ from the illustration.

The purpose of the air bag is to provide the vehicle's driver and/or the front passenger with additional protection than that offered by the seat belt alone.

The side air bags are designed to deploy only during certain side-impact collisions, depending on the crash severity, angle, speed and point of impact. The side air bags are not designed to deploy in all side impact situations.

#### **⚠ WARNING**

Do not allow the passengers to lean their heads or bodies onto doors, put their

arms on the doors, stretch their arms out of the window, or place objects between the doors and passengers when they are seated on seats equipped with side and/or curtain air bags.

#### **⚠ WARNING**

- The side air bag is supplemental to the driver's and the passenger's seat belt systems and is not a substitute for them. Therefore your seat belts must be worn at all times whilst the vehicle is in motion. The air bags deploy only in certain side impact conditions severe enough to cause significant injury to the vehicle occupants.
- For best protection from the side air bag system and to avoid being injured by the deploying side air bag, both front seat occupants should sit in an upright position with the seat belt properly fastened.
- Do not use any accessory seat covers.
- Use of seat covers could reduce or prevent the effectiveness of the system.
- To prevent unexpected deployment of the side air bag that may result in personal injury, avoid impact to the side impact sensor when the ignition key is on.
- If the seat or seat cover is damaged, have the system serviced by a professional workshop. Kia recommends to visit an authorised Kia dealer/service partner.



3

**⚠ WARNING**

**No attaching objects**

- Do not place any objects over the air bag or between the air bag and yourself. Also, do not attach any objects around the area the air bag inflates such as the door, side door glass, front and rear pillar.
- Do not place any objects between the door and the seat. They may become dangerous projectiles if the side air bag inflates.
- Do not install any accessories on the side or near the side air bags.

**Curtain air bag**

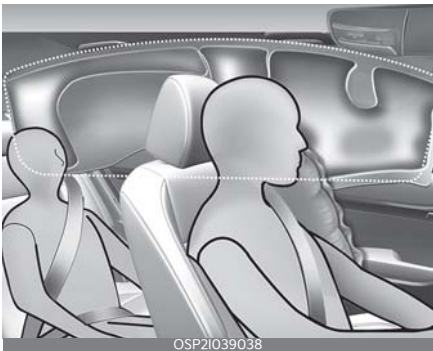

\* The actual air bags in the vehicle may differ from the illustration.

Curtain air bags are located along both sides of the roof rails above the front and rear doors.

They are designed to help protect the heads of the front seat occupants and the rear outboard seat occupants in certain side impact collisions.

The curtain air bags are designed to deploy during certain side impact collisions, depending on the crash severity, angle, speed and point of impact. The curtain air bags are not designed to deploy in all side impact situations, collisions from the front or rear of the vehicle or in most rollover situations.

**⚠ WARNING**

- Do not hang heavy items on the coat hooks for safety reasons.
- In order for side and curtain air bags to provide the best protection, both front seat occupants and both outboard rear occupants should sit in an upright position with the seat belts properly fastened.

Importantly, children should sit in a proper child restraint system in the rear seat.

- When children are seated in the rear outboard seats, they must be seated in the proper child restraint system. Make sure to put the child restraint system as far away from the door side as possible, and secure the child restraint system in a locked position.
- Do not allow the passengers to lean their heads or bodies onto doors, put their arms on the doors, stretch their arms out of the window, or place objects between the doors and passengers when they are seated on seats equipped with side and/or curtain air bags.

## Safety features of your vehicle

- Never try to open or repair any components of the curtain air bag system. If necessary, have the system serviced by a professional workshop. Kia recommends to visit an authorised Kia dealer/service partner.

Failure to follow the above mentioned instructions can result in injury or death to the vehicle occupants in an accident.

### WARNING

#### **No attaching objects**

- Do not place any objects over the air bag. Also, do not attach any objects around the area the air bag inflates such as the door, side door glass, front and rear pillar, roof side rail.

## Air bag - supplemental restraint system

3



### Air bag collision sensors



OSP21033039



OSP21033044



OSP21033040



OSP21039041

\* The actual shape and position of sensors may differ from the illustration.

1. Supplemental Restraint System (SRS) control module
2. Front impact sensor
3. Side impact sensor

**⚠ WARNING**

- Do not hit or allow any objects to impact the locations where air bag or sensors are installed.

This may cause unexpected air bag deployment, which could result in serious personal injury or death.

- If the installation location or angle of the sensors is altered in any way, the air bags may deploy when they should not or they may not deploy when they should, causing severe injury or death.

Therefore, do not try to perform maintenance on or around the air bag sensors. Have the system serviced by a professional workshop. Kia recommends to visit an authorised Kia dealer/service partner.

- Problems may arise if the sensor installation angles are changed due to the deformation of the front bumper, body or B pillar where side collision sensors are installed. In this case, have the system serviced by a professional workshop. Kia recommends to visit an authorised Kia dealer/ service partner.
- Your vehicle has been designed to absorb impact and deploy the air bag(s) in certain collisions. Use only Kia Genuine Parts or those of an equivalent standard to install bumper guards or replace a bumper. If not, it may adversely affect your vehicle's collision and air bag deployment performance.

**Why didn't my air bag go off in a collision? (Inflation and non-inflation conditions of the air bag)**

There are many types of accidents in which the air bag would not be expected to provide additional protection.

These include rear impacts, second or third collisions in multiple impact accidents, as well as low speed impacts.

**Air bag inflation conditions****Front air bags**

Front air bags are designed to inflate in a frontal collision depending on the intensity, speed or angles of impact of the front collision.

### Side and curtain air bags (if equipped)

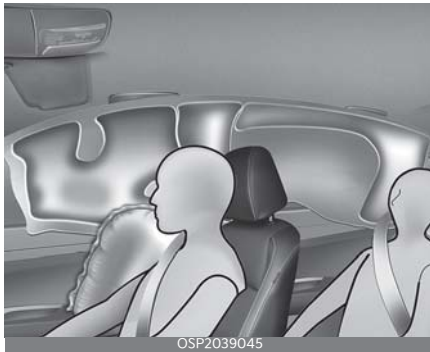

\* The actual air bags in the vehicle may differ from the illustration.

Side and/or curtain air bags are designed to inflate when an impact is detected by side collision sensors depending on the strength, speed or angles of impact resulting from a side impact collision.

Although the front air bags (driver's and front passenger's air bags) are designed to inflate only in frontal collisions, they also may inflate in other types of collisions if the front impact sensor detect a sufficient impact. Side air bags (side and/or curtain air bags) are designed to inflate only in side impact collisions, but they may inflate in other collisions if the

side impact sensors detect a sufficient impact.

If the vehicle chassis is impacted by bumps or objects on unimproved roads or sidewalks, air bags may deploy. Drive carefully on unimproved roads or on surfaces not designed for vehicle traffic to prevent unintended air bag deployment.

### Air bag non-inflation conditions

- In certain low-speed collisions the air bags may not deploy. The air bags are designed not to deploy in such cases because they may not provide benefits beyond the protection of the seat belts in such collisions.



- Air bags are not designed to inflate in rear collisions, because occupants are moved backward by the force of the impact. In this case, inflated air bags would not be able to provide any additional benefit.

## Safety features of your vehicle

## Air bag - supplemental restraint system



- Front air bags may not inflate in side impact collisions, because occupants move to the direction of the collision, and thus in side impacts, frontal air bag deployment would not provide additional occupant protection.



- However, if equipped with side and curtain air bags, the air bags may inflate depending on the intensity, vehicle speed and angles of impact.
- In an angled collision, the force of impact may direct the occupants in a direction where the air bags would not be able to provide any additional benefit, and thus the sensors may not deploy any air bags.

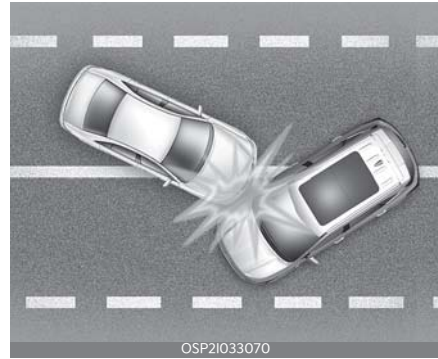

- Just before impact, drivers often brake heavily. Such heavy braking lowers the front portion of the vehicle causing it to "ride" under a vehicle with a higher ground clearance. Air bags may not inflate in this "under-ride" situation because deceleration forces that are detected by sensor may be significantly replaced by such "under-ride" collisions.



- Air bags may not inflate in rollover accidents because the vehicle can not detect rollover accident. However, side and/or curtain air bags may inflate when the vehicle is rolled over following (or after) side impact collision.

3

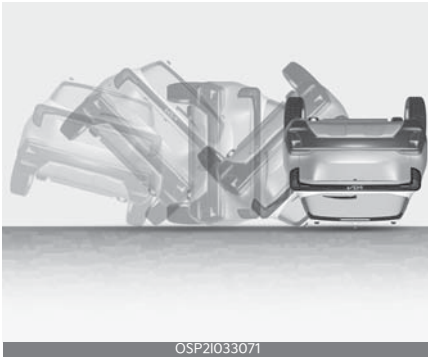

OSP21033071

- Air bags may not inflate if the vehicle collides with objects such as utility poles or trees, where the point of impact is concentrated to one area and the full force of the impact is not delivered to the sensor.



OSP21033063

### SRS care

The SRS is virtually maintenance-free and so there are no parts you can safely service by yourself.

If the SRS air bag warning light does not illuminate, or continuously remains on, have the system inspected by a professional workshop. Kia recommends to visit an authorised Kia dealer/service partner.

### ⚠ WARNING

- Modification to SRS components or wiring, including the addition of any kind of badges to the pad covers or modifications to the body structure, can adversely affect SRS performance and lead to possible injury.
- For cleaning the air bag pad covers, use only a soft, dry cloth or one which has been moistened with plain water. Solvents or cleaners could adversely affect the air bag covers and proper deployment of the system.
- No objects should be placed over or near the air bag modules on the steering wheel, instrument panel, and the front passenger's panel above the glove box, because any such object could cause harm if the vehicle is in a crash severe enough to cause the air bags to inflate.
- If the air bags inflate, have the system replaced by a professional workshop. Kia recommends to visit an authorised Kia dealer/service partner.
- Do not tamper with or disconnect SRS wiring, or other components of the SRS system. Doing so could result in injury, due to accidental inflation of the air bags or by rendering the SRS inoperative.

- If components of the air bag system must be discarded, or if the vehicle must be scrapped, certain safety precautions must be observed. An authorised Kia dealer knows these precautions and can give you the necessary information. Failure to follow these precautions and procedures could increase the risk of personal injury.
- If your car was flooded and has soaked carpeting or water on flooring, you shouldn't try to start the engine; in this case, have your vehicle inspected by a professional workshop. Kia recommends to contact an authorised Kia dealer/service partner.

### Additional safety precautions

- **Never let passengers ride in the cargo area or on top of a folded-down back seat.** All occupants should sit upright, fully back in their seats with their seat belts on and their feet on the floor.

### Adding equipment to or modifying your air bag-equipped vehicle

If you modify your vehicle by changing your vehicle's frame, bumper system, front end or side sheet metal or ride height, this may affect the operation of your vehicle's air bag system.

### Air bag warning label

Air bag warning labels are attached to alert driver and passengers of potential risk of air bag system.



3

Note that these government warnings focus on the risk of children. We also want you to be aware of the risks adults are exposed to which have been described in previous pages.

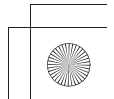
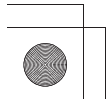
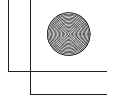
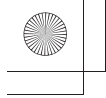

# Features of your vehicle **4**

<b>Keys</b> .....	<b>4-6</b>
• Record your key number.....	4-6
• Battery replacement.....	4-6
• Key operations.....	4-7
<b>Remote keyless entry</b> .....	<b>4-8</b>
• Remote keyless entry system operations.....	4-8
• Transmitter precautions.....	4-9
<b>Smart key</b> .....	<b>4-10</b>
• Smart key functions.....	4-11
• Smart key precautions.....	4-11
<b>Immobiliser system</b> .....	<b>4-12</b>
• Vehicles without smart key system.....	4-12
• Vehicles with smart key system.....	4-12
<b>Theft-alarm system</b> .....	<b>4-14</b>
• Armed stage.....	4-14
• Theft-alarm stage.....	4-15
• Disarmed stage.....	4-15
<b>Door locks</b> .....	<b>4-16</b>
• Operating door locks from outside the vehicle (for smart key).....	4-16
• Operating door locks from inside the vehicle.....	4-17
• Door lock/unlock features.....	4-18
• Child-protector rear door lock.....	4-19
<b>Tailgate</b> .....	<b>4-20</b>
• Opening the tailgate.....	4-20
• Closing the tailgate.....	4-20
• Emergency tailgate safety release.....	4-21
<b>Windows</b> .....	<b>4-22</b>
• Window opening and closing.....	4-23
• Power window lock button.....	4-25
<b>Bonnet</b> .....	<b>4-26</b>



## 4 Features of your vehicle

• Opening the bonnet .....	4-26
• Bonnet open warning.....	4-27
• Closing the bonnet .....	4-27
<b>Fuel filler door.....</b>	<b>4-28</b>
• Opening the fuel filler door .....	4-28
• Closing the fuel filler door .....	4-29
<b>Panorama sunroof .....</b>	<b>4-31</b>
• Power sunshade.....	4-31
• Tilt open/close .....	4-32
• Slide open/close .....	4-32
• Automatic reversal .....	4-32
• Resetting the sunroof.....	4-33
• Sunroof open warning.....	4-34
<b>Steering wheel .....</b>	<b>4-35</b>
• Motor Driven Power Steering (MDPS) .....	4-35
• Tilt & telescopic steering wheel .....	4-36
• Horn .....	4-37
<b>Mirrors.....</b>	<b>4-37</b>
• Inside rearview mirror .....	4-37
• Outside rearview mirror .....	4-38
<b>Instrument cluster.....</b>	<b>4-41</b>
• Instrument cluster.....	4-42
• Gauges.....	4-43
• Transmission shift indicator .....	4-47
<b>LCD display.....</b>	<b>4-49</b>
• LCD display modes .....	4-50
• Trip information (trip computer) .....	4-57
• Auto stop .....	4-60
• Service mode .....	4-60
• Service interval.....	4-61
• LCD display messages.....	4-61

# Features of your vehicle **4**

<b>Warning and indicator lights</b> .....	<b>4-65</b>
• Warning lights.....	4-65
• Indicator lights.....	4-71
<b>Infotainment system vehicle settings</b> .....	<b>4-75</b>
• Setting your vehicle.....	4-75
• Vehicle Settings menu .....	4-76
<b>Head-Up Display (HUD)</b> .....	<b>4-76</b>
• Head Up Display Information .....	4-77
• Head up Display Setting .....	4-77
<b>Lighting</b> .....	<b>4-78</b>
• Battery saver function.....	4-78
• Daytime Running Light (DRL).....	4-78
• Lighting control.....	4-78
• Operating high beam .....	4-79
• Operating turn signals and lane change signals .....	4-80
• Operating front fog light .....	4-80
• High Beam Assist (HBA).....	4-81
• Headlight levelling device .....	4-84
<b>Wipers and washers</b> .....	<b>4-85</b>
• Auto control.....	4-86
• Operating windscreen washers.....	4-87
• Operating rear window wiper and washer switch.....	4-87
<b>Interior lights</b> .....	<b>4-88</b>
• Automatic turn off function.....	4-88
• Map lamp.....	4-88
• Room lamp.....	4-89
• Personal lamp.....	4-89
• Luggage room lamp .....	4-90
<b>Welcome system</b> .....	<b>4-90</b>
<b>Rear Defroster (if equipped)</b> .....	<b>4-91</b>
• Operating rear window defroster .....	4-91

## 4 Features of your vehicle

<b>Climate control system .....</b>	<b>4-92</b>
• System operation.....	4-92
• Climate control air filter.....	4-93
• Checking the amount of air conditioner refrigerant and compressor lubricant.....	4-94
• Air conditioning refrigerant label.....	4-94
<b>Manual climate control system .....</b>	<b>4-96</b>
• Heating and air conditioning .....	4-97
<b>Automatic climate control system.....</b>	<b>4-101</b>
• Heating and air conditioning automatically.....	4-102
• Heating and air conditioning manually.....	4-104
<b>Windscreen defrosting and defogging.....</b>	<b>4-110</b>
• Defogging inside windscreen with manual climate control system.....	4-110
• Defrosting outside windscreen with manual climate control system .....	4-111
• Defogging inside windscreen with the automatic climate control.....	4-111
• Defrosting outside windscreen with automatic climate control.....	4-112
<b>Storage compartment .....</b>	<b>4-112</b>
• Centre console storage .....	4-112
• Glove box .....	4-113
• Sunglass holder .....	4-113
• Luggage net holder.....	4-114
• Luggage board.....	4-114
<b>Interior features .....</b>	<b>4-115</b>
• Ambient light and Sound mood lamp.....	4-115
• Ashtray.....	4-115
• Cup holder .....	4-115
• Sliding armrest .....	4-116

# Features of your vehicle **4**

- Air ventilation seat ..... 4-117
- Sun visor..... 4-117
- Power outlet ..... 4-118
- USB charger ..... 4-119
- Wireless smart phone charging system..... 4-120
- Coat hook ..... 4-122
- Floor mat anchor(s)..... 4-123
- Cargo area cover ..... 4-124
- Side curtain ..... 4-124
- Exterior features ..... 4-125**
- Roof rack..... 4-125
- Infotainment system ..... 4-126**
- Audio system..... 4-126

## Features of your vehicle

### Keys

#### **▲ WARNING**

Leaving children unattended in a vehicle with the ignition key (smart key) is dangerous even if the key is not in the ignition switch or ENGINE START/STOP button is ACC or ON position.

Children copy adults and they could place the key in the ignition switch or press the ENGINE START/STOP button. The ignition key (smart key) would enable children to operate power windows or other controls, or even make the vehicle move, which could result in SERIOUS BODILY INJURY OR EVEN DEATH. Never leave the keys in your vehicle with unsupervised children, when the engine is running.

#### **Record your key number**

The key code number is stamped on the key code tag attached to the key set.

If you lose your keys, Kia recommends to contact an authorised Kia dealer/service partner. Remove the key code tag and store it in a safe place. Also, record the key code number and keep it in a safe place (not in the vehicle).

### Battery replacement

The folding key or smart key uses a 3 volt lithium battery which will normally last for several years.

#### Folding key



OTAM0422242

#### Smart key



OSP2042491L

When replacement is necessary, use the following procedure.

1. Insert a slim tool into the slot and gently pry open the key cover.
2. Loosen the retaining screw of the battery cover and then remove the cover (for folding key).
3. Replace the battery with a new battery (CR2032). When replacing the battery, make sure the battery position.

4. Install the battery in the reverse order of removal.

For folding key or smart key replacement, Kia recommends to visit an authorised Kia dealer/service partner.

**⚠ WARNING**

**THIS PRODUCT CONTAINS A BUTTON BATTERY**

If swallowed, a lithium button battery can cause severe or fatal injuries within 2 hours.

Keep batteries out of reach of children.

If you think batteries may have been swallowed or placed inside any part of the body, seek immediate medical attention.

**⚠ CAUTION**

- The keyless entry system transmitter is designed to give you years of trouble-free use, however it can malfunction if exposed to moisture or static electricity. If you are unsure how to use or replace the battery, Kia recommends to contact an authorised Kia dealer/service partner.
- Using the wrong battery can cause the folding key or smart key to malfunction. Be sure to use the correct battery.
- To avoid damaging the transmitter or smart key, don't drop it, get it wet, or expose it to heat or sunlight.

**⚠ CAUTION**



An inappropriately disposed battery can be harmful to the environment and human health.

Dispose the battery according to your local law(s) or regulation.

**Key operations**

**Folding key (if equipped)**



To unfold the key:

- press the release button then the key will unfold automatically.

To fold the key:

- fold the key manually whilst pressing the release button.

**⚠ CAUTION**

Do not fold the key without pressing the release button. This may damage the key.

### Smart key (if equipped)



OSP2042473L

To pull out the mechanical key:

- press and hold the release button (1) and remove the mechanical key (2).

To reinstall the mechanical key:

- put the key into the hole and push it until a click sound is heard.

#### **⚠ WARNING**

Kia recommends to use parts for replacement from an authorised Kia dealer/service partner. If an aftermarket key is used, the ignition switch may not return to ON after START. If this happens, the starter will continue to operate causing damage to the starter motor and possible fire due to excessive current in the wiring.

### Remote keyless entry

#### Remote keyless entry system operations

##### Folding key



OSP2042489L

##### Smart key - Type A



OSP2042496L

##### Smart key - Type B



OSP2042415L

### Lock (1)

All doors are locked if the lock button is pressed whilst all doors are closed.

The hazard warning lights will blink once to indicate that all doors are locked.

However, if any door, engine bonnet or tailgate remains open, the hazard warning lights will not operate. If all doors, engine bonnet and tailgate are closed after the lock button is pressed, the hazard warning lights will blink once.

### Unlock (2)

All doors are unlocked if the unlock button is pressed.

The hazard warning lights will blink twice to indicate that all doors are unlocked.

After pressing this button, the doors will lock automatically unless you open any door within 30 seconds.

### Tailgate unlock (3) (for non-power tailgate)

If you press this button for longer than a second, the lock will be released. Once the tailgate is opened and then closed, the tailgate will lock automatically when all doors are locked.

### Tailgate open/close (3) (for power tailgate, if equipped)

If you press this button for longer than a second the tailgate will be opened. When the power tailgate is opened, press and hold the power tailgate open/close button to close the tailgate. If you release the button whilst the tailgate is closing, power tailgate operation will stop with a warning sound for 5 seconds.

Once the tailgate is opened and then closed, the tailgate will lock automatically when all doors are locked.

### Remote start (4) (if equipped)

You can start the vehicle using the remote start button of the smart key.

To start the vehicle remotely:

- Lock the doors by pressing the door lock button (1) within 10 m (32 feet) distance from the vehicle.
- Press the remote start button for over 2 seconds within 4 seconds after locking the doors.

Press the remote start button once to turn off the vehicle.

If no further action for operating/driving the vehicle is taken, the vehicle will be turned off 10 minutes after starting the vehicle remotely.

### Transmitter precautions

#### \* NOTICE

The transmitter will not work if any of the following occurs:

- The ignition key is in the ignition switch.
- You exceed the operating distance limit (about 10 m [30 feet]).
- The battery in the transmitter is weak.
- Other vehicles or objects may be blocking the signal.
- The weather is extremely cold.
- The transmitter is close to a radio transmitter such as a radio station or an airport which can interfere with normal operation of the transmitter.

When the transmitter does not work correctly, open and close the door with the ignition key. If you have a problem with the transmitter, Kia recommends to con-



tact an authorised Kia dealer/service partner.

- If the transmitter is in close proximity to your cell phone or smart phone, the signal from the transmitter could be blocked by normal operation of your cell phone or smart phone. This is especially important when the phone is active such as making call, receiving calls, text messaging, and/or sending/receiving emails.

Avoid placing the transmitter and your cell phone or smart phone in the same pants or jacket pocket and maintain adequate distance between the two devices.

#### \* NOTICE

To prevent the damaging the folding key (smart key):

- Keep the folding key (smart key) away from water or any liquid and fire. If the inside of the folding key (smart key) gets damp (due to drinks or moisture), or is heated, internal circuit may malfunction, excluding the car from the warranty.
- Avoid dropping or throwing the folding key (smart key).
- Protect the folding key (smart key) from extreme temperature.

## Smart key (if equipped)

Type A



OSP2042492L

Type B



OSP2042414L

With a smart key, you can lock or unlock a door and even start the engine without inserting the key.

The functions of buttons on a smart key are similar to the folding key.

\* For more information, refer to "Remote keyless entry" on page 4-8.

## Smart key functions



Carrying the smart key, you may lock and unlock the vehicle doors (and tailgate). Also, you may start the engine. Refer to the following for more details.

### Locking

Pressing the button of the front driver side door handles with all doors closed and any door unlocked, locks all the doors. If all doors and engine bonnet are closed, the hazard warning lights will blink once to indicate that all doors are locked.

The button will only operate when the smart key is within 0.7~1 m (28~40 inches) from the driver side door handle. If you want to make sure that a door has locked or not, you should check pull the driver side door handle.

Even though you press the driver side door handle buttons, the doors will not lock and the chime will sound for 3 seconds if any of following occur:

- The smart key is in the vehicle.
- The ENGINE START/STOP button is in the ACC or ON position.
- Any door except the tailgate is open.

### Unlocking

Pressing the button of the front driver side door handles with all doors closed and locked, unlocks all the doors. The hazard warning lights blink twice to indicate that all doors are unlocked.

The button will only operate when the smart key is within 0.7~1 m (28~40 inches) from the front driver side door handle.

When the smart key is recognized in the area of 0.7~1 m (28~40 inches) from the front driver side door handle, other people can also open the door without possession of the smart key.

After pressing the button, the doors will lock automatically unless you open any door within 30 seconds.

### Tailgate open

Press the tailgate handle switch carrying the smart key with you and open the tailgate.

Once the tailgate is opened and then closed, the tailgate will lock automatically when all doors are locked.

### Start-up

You can start the vehicle without inserting the key.

\* For more information, refer to "ENGINE START/STOP button" on page 5-9.

### Smart key precautions

#### \* NOTICE

- If, for some reason, you happen to lose your smart key, you will not be able to start the engine. Tow the vehicle, if necessary, contact a professional workshop. Kia recommends to

contact an authorised Kia dealer/service partner.

- A maximum of 2 smart keys can be registered to a single vehicle. If you lose a smart key, Kia recommends to contact an authorised Kia dealer/service partner.
- The smart key will not work if any of the following occurs:
  - The smart key is close to a radio transmitter such as a radio station or an airport which can interfere with normal operation of the smart key.
  - The smart key is near a mobile two-way radio system or a mobile phone.
  - Another vehicle's smart key is being operated close to your vehicle.

When the smart key does not work properly, open and close the door with the mechanical key. If you have a problem with the smart key, Kia recommends to contact an authorised Kia dealer/service partner.

## Immobiliser system

The vehicle is designed with an electronic engine immobilizer system to reduce the risk of unauthorized vehicle use.

Your immobiliser system is comprised of a small transponder in the ignition key and electronic devices inside the vehicle.

### Vehicles without smart key system

With the immobiliser system, whenever you insert your ignition key into the ignition switch and turn it to ON, it checks and determines and verifies if the ignition key is valid or not.

If the key is valid, the engine will start.

If the key is invalid, the engine will not start.

### To deactivate the immobiliser system:

Insert the ignition key into the key cylinder and turn it to the ON position.

### To activate the immobiliser system:

Turn the ignition key to the OFF position. The immobiliser system activates automatically. Without a valid ignition key for your vehicle, the engine will not start.

### Vehicles with smart key system

Whenever the ENGINE START/STOP buttons are changed to the ON position, the immobiliser system checks and verifies if the key is valid or not.

If the key is valid, the engine will start.

If the key is invalid, the engine will not start.

### To deactivate the immobiliser system

Change the ENGINE START/STOP button to the ON position.

### To activate the immobiliser system

Change the ENGINE START/STOP button to the OFF position. The immobiliser system activates automatically. Without a valid smart key for your vehicle, the engine will not start.

#### **⚠ WARNING**

In order to prevent theft of your vehicle, do not leave spare keys anywhere in your vehicle. Your immobiliser password is a customer unique password and should be kept confidential. Do not leave this number anywhere in your vehicle.

#### **\* NOTICE**

When starting the engine, do not use the key with other immobiliser keys around. Otherwise the engine may not start or may stop soon after it starts. Keep each key separately in order to avoid a starting malfunction.

#### **⚠ CAUTION**

Do not put metal accessories near the ignition switch. Metal accessories may interrupt the transponder signal and may prevent the engine from being started.

#### **\* NOTICE**

If you need additional keys or lose your keys, Kia recommends to visit an authorised Kia dealer/service partner.

#### **⚠ CAUTION**

The transponder in your ignition key is an important part of the immobiliser system. It is designed to give years of trouble-free service, however you should avoid exposure to moisture, static electricity and rough handling. Immobiliser system malfunction could occur.

#### **⚠ CAUTION**

- Do not change, alter or adjust the immobiliser system because it could cause the immobiliser system to malfunction. In this case, have the system serviced by a professional workshop. Kia recommends to visit an authorised Kia dealer/service partner.
- Malfunctions caused by improper alterations, adjustments or modifications to the immobiliser system are not covered by your vehicle manufacturer warranty.
- Do not attempt to alter this system or add other devices to it. Electrical problems could result that may make your vehicle inoperable.

## Theft-alarm system (if equipped)

Theft-alarm system is designed to provide protection from unauthorised entry into the vehicle.

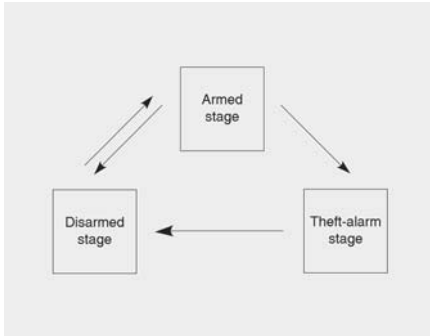

This system is operated in three stages:

- Armed stage
- Theft-alarm stage
- Disarmed stage

If triggered, the system provides an audible alarm with blinking of the hazard warning lights.

**CAUTION**  
Do not attempt to alter this system or add other devices to it.

### Armed stage

Theft Alarm System goes to Armed stage after 30 seconds from the doors are locked by switch on a Outside Door Handle/by a lock button on transmitter.

### Using the smart key

Park the vehicle and stop the engine. Arm the system as described below.

1. Turn off the engine.
2. Make sure that all doors (and tailgate) and the engine bonnet are closed and latched.

3. Do one of the following:

- Lock the doors by pressing the button of the front outside door handle with the smart key in your possession.

After completion of the steps above, the hazard warning lights operate once to indicate that the system is armed.

If any door remains open, the doors won't lock and the chime will sound for 3 seconds. Close the door and try again to lock the doors.

If tailgate or engine bonnet remains open, the hazard warning lights won't operate and theft-alarm will not arm. After this, if the tailgate and engine bonnet are closed, the hazard warning lights will blink once.

- Lock the doors by pressing the lock button on the smart key.

After completion of the steps above, the hazard warning lights will operate once to indicate that the system is armed.

If any door (and tailgate) or engine bonnet remains open, the hazard warning lights won't operate and theft-alarm will not arm. After this, if all doors (and tailgate) and engine bonnet are closed, the hazard warning lights blink once.

### Using the transmitter

Park the vehicle and stop the engine. Arm the system as described below.

1. Turn off the engine and remove the ignition key from the ignition switch.
2. Make sure that all doors (and tailgate), the engine bonnet are closed and latched.

3. Lock the doors by pressing the lock button on the transmitter.  
After completion of the steps above, the hazard warning lights will blink once to indicate that the system is armed.  
If any door (and tailgate) or engine bonnet remains open, the hazard warning lights won't operate and theft-alarm will not arm. After this, if all doors (and tailgate) and engine bonnet are closed, the hazard warning lights blink once.

### Theft-alarm stage

The alarm will be activated if any of the following occurs whilst the system is armed.

- A door is opened without using the transmitter (or smart key).
- The tailgate is opened without using the transmitter (or smart key).
- The engine bonnet is opened.

The horn will sound and the hazard warning lights will blink continuously for approximately 30 seconds. To turn off the system, unlock the doors with the transmitter (or smart key).

### Disarmed stage

The system will be disarmed when:

#### Transmitter

- The door unlock button is pressed.
- The engine is started.
- The ignition switch is in the "ON" position for 30 seconds or more.

#### Smart key

- The door unlock button is pressed.
- The button of the front outside door is pressed whilst carrying the smart key.

- The engine is started.

After the doors are unlocked, the hazard warning lights will blink twice to indicate that the system is disarmed.

After pressing the unlock button, if any door (or tailgate) is not opened within 30 seconds, the system will be rearmed.

### \* NOTICE

#### Non-immobiliser system

- Avoid trying to start the engine whilst the alarm is activated. The vehicle starting motor is disabled during the theft-alarm stage.

If the system is not disarmed with the transmitter, insert the key into the ignition switch, turn the ignition switch to the ON position and wait for 30 seconds. Then the system will be disarmed.

4

## Door locks

Know how to use the door lock so that you can lock or unlock the door if necessary.

### Operating door locks from outside the vehicle (for smart key)



1. Pull out the mechanical key from smart key.
  2. Insert the mechanical key into the keyhole outside of driver's door.
  3. Turn the key toward the rear of the vehicle to lock and toward the front of the vehicle to unlock.
- Doors can also be locked and unlocked with the transmitter.
  - Once the doors are unlocked, they may be opened by pulling the door handle.
  - When closing the door, push the door by hand. Make sure the doors are closed securely.

#### **⚠ CAUTION**

Be careful not to damage the cover whilst removing it or misplace it after removing it.

#### **\* NOTICE**

- In cold and wet climates, door lock and door mechanisms may not work properly due to freezing conditions.
- If the door is locked/unlocked multiple times in rapid succession with either the vehicle key or door lock switch, the system may stop operating temporarily in order to protect the circuit and prevent damage to system components.

#### **⚠ WARNING**

- If you don't close the door securely, the door may open again.
- Be careful that someone's body and hands are not trapped when closing the door.

#### **⚠ WARNING**

If people must spend a longer time in the vehicle whilst it is very hot or cold outside, there is risk of injuries or danger to life. Do not lock the vehicle from the outside when there are people in it.

#### **⚠ CAUTION**

Do not frequently repeat opening and closing of doors, or apply excessive force to a door whilst the door closer is operating.

## Operating door locks from inside the vehicle

You can operate door locks with the door lock button or central door lock switch.

### With the door lock button

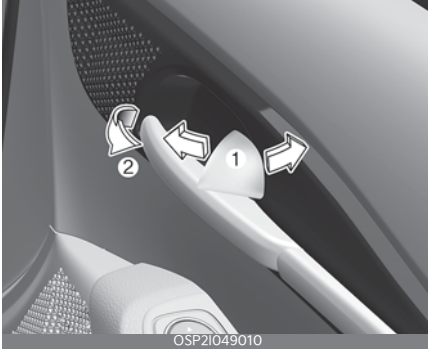

- To unlock a door, push the door lock button (1) to the "Unlock" position.
- To lock a door, push the door lock button (1) to the "Lock" position.
- To open a door, pull the door handle (2) outward.

If the inner door handle of the driver's door is pulled when the door lock button is in the lock position, the button will unlock and the door will open.

Front doors cannot be locked if the ignition key is in the ignition switch and any front door is opened.

Doors cannot be locked if the smart key is in the vehicle and an door is open.

- Front door
  - If the inner door handle is pulled when the door is locked, the door will unlock and open.
- Rear door
  - If the inner door handle is pulled once when the door is locked, the door will unlock.

- If the inner door handle is pulled once more, the door will open.

### **⚠ WARNING**

#### Door lock malfunction

If a power door lock ever fails to function whilst you are in the vehicle, try one or more of the following techniques to exit:

- Operate the door unlock feature repeatedly (both electronic and manual) whilst simultaneously pulling on the door handle.
- Operate the other door locks and handles, front and rear.
- Lower a front window and use the key to unlock the door from outside.
- Move to the cargo area and open the tailgate.



4

### **⚠ WARNING**

Do not pull the inner door handle of driver's (or passenger's) door whilst the vehicle is moving.



## With central door lock switch



Operate by pressing the central door lock switch.

- To lock all vehicle doors, press the left portion (1) for driver side of the switch.
- To unlock all vehicle doors, press the right portion (2) for driver side of the switch.

If the key is in the ignition switch (or if the smart key is in the vehicle) and any door is opened, the doors will not lock even though the left portion (1) for driver side of the central door lock switch is pressed.

### **⚠ WARNING**

#### **Doors**

- The doors should always be fully closed and locked whilst the vehicle is in motion to prevent accidental opening of the door. Locked doors will also discourage potential intruders when the vehicle stops or slows down.
- Be careful when opening doors and watch out for vehicles, motorcycles, bicycles or pedestrians approaching the vehicle in the path of the door. Opening a door when something is approaching can result in an accident

to cause vehicle damage or serious injury.

### **⚠ WARNING**

#### **Unlocked vehicles**

Leaving your vehicle unlocked can increase the risk of vehicle theft or any possible criminal harm caused by someone hiding in your vehicle whilst you are gone. Always remove the ignition key, engage the parking brake, close all windows and lock all doors when leaving your vehicle unattended.

### **⚠ WARNING**

#### **Unattended children, the elderly or pets**

An enclosed vehicle can become extremely hot, causing death or severe injury such as heatstroke to unattended children, the elderly or pets who cannot escape the vehicle. When left or trapped in a hot vehicle, make sure to stay hydrated and avoid sun exposure through the vehicle's windshield. Furthermore, children might operate features of the vehicle that could injure them, or they could encounter other harm, possibly from someone gaining entry to the vehicle. Never leave children or animals unattended in your vehicle.

#### **Door lock/unlock features**

The vehicle is equipped with door lock/unlock features for the safety and convenience of passengers.

#### **Impact sensing door unlock system**

All doors will automatically unlock when an impact causes the air bags to deploy.

### Speed sensing door lock system

All doors will automatically lock after the vehicle speed exceeds 15 km/h.

You can activate or deactivate the auto door lock/unlock features in the vehicle. Refer to "User settings mode (if equipped)" on page 4-52.

### Child-protector rear door lock

The child safety lock is provided to help prevent children from accidentally opening the rear doors from inside the vehicle.



The rear door safety locks should be used whenever children are in the vehicle.

The child safety lock is located on the edge of each rear door. When the child safety lock is in the lock position (1), the rear door will not open if the inner door handle is pulled.

To lock the child safety lock, insert a key (or screwdriver) into the hole and turn it to the lock position.

To allow a rear door to be opened from inside the vehicle, unlock the child safety lock.

### ⚠ WARNING

#### Rear door locks

If children accidentally open the rear doors whilst the vehicle is in motion, they could fall out and be severely injured or killed. To prevent children from opening the rear doors from the inside, the rear door safety locks should be used whenever children are in the vehicle.

## Tailgate

### ⚠ WARNING

#### Exhaust fumes

If you drive with the tailgate opened, you will draw dangerous exhaust fumes into your vehicle which can cause serious injury or death to vehicle occupants.

If you must drive with the tailgate opened, keep the air vents and all windows open so that additional outside air comes into the vehicle.

### ⚠ WARNING

#### Rear cargo area

Occupants should never ride in the rear cargo area where no restraints are available. To avoid injury in the event of an accident or sudden stops, occupants should always be properly restrained.

### Opening the tailgate

The tailgate is locked or unlocked when all doors are locked or unlocked with the key, transmitter, smart key or central door lock/unlock switch.



1. To unlock the tailgate only, press the tailgate unlock button on the transmitter or smart key for approximately 1 second.

2. To open the tailgate, press the handle and pull it up.

Once the tailgate is opened and then closed, the tailgate locks automatically. (All doors must be locked.)

### \* NOTICE

In cold and wet climates, door lock and door mechanisms may not work properly due to freezing conditions.

### ⚠ WARNING

The tailgate swings upward. Make sure no objects or people are near the rear of the vehicle when opening the tailgate.

### ⚠ CAUTION

Make certain that you close the tailgate before driving your vehicle. Possible damage may occur to the tailgate gas lifters and attaching hardware if the tailgate is not closed prior to driving.

### Closing the tailgate



1. Lower and push down the tailgate firmly.
2. Make sure that the tailgate is securely latched.

**⚠ WARNING**  
 Make sure your hands, feet and other parts of your body are safely out of the way before closing the tailgate.

**⚠ CAUTION**  
 Make sure nothing is near the tailgate latch and striker whilst closing the tailgate. It may damage the tailgate's latch.

**Emergency tailgate safety release**  
 Your vehicle is equipped with the emergency tailgate safety release lever located on the bottom of the tailgate.



If you have to open the tailgate urgently inside the tailgate due to battery discharge, external handle failure, or other reasons.

The tailgate can be opened by doing as follows:

1. Input the mechanical key into the hole.
2. Push the mechanical key to the right (1).
3. Push up the tailgate.

**⚠ WARNING**  
 Do not grasp the part supporting the tailgate (gas lifter), as this may cause serious injury.



4

## Windows

The doors of this vehicle are equipped with power windows that can be operated by a switch.

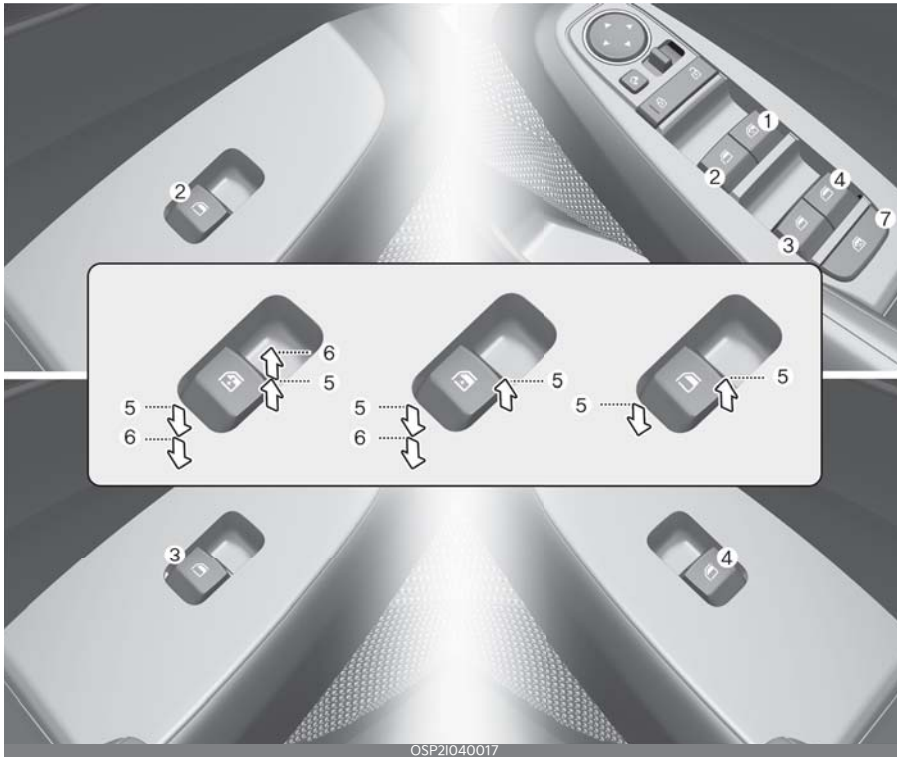

1. Driver's door power window switch
2. Front passenger's door power window switch
3. Rear door (left) power window switch
4. Rear door (right) power window switch
5. Window opening and closing
6. Automatic power window up\*/down\*
7. Power window lock switch

\*: if equipped

**\* NOTICE**

In cold and wet climates, power windows may not work properly due to freezing conditions.

The ignition switch must be in the ON position for power windows to operate. Each door has a power window switch that controls the door's window. The driver has a power window lock button which can block the operation of rear passenger windows. The power windows can be operated for approximately 10 minutes after the ignition key is removed or turned to the ACC or LOCK position. However, if the front doors are opened, the power windows cannot be operated even within the 10 minutes period.

The driver's door has a master power window switch that controls all the windows in the vehicle.

If the window cannot be closed because it is blocked by objects, remove the objects and close the window.

**\* NOTICE**

Whilst driving with the rear windows down or with the sunroof (if equipped) in an open (or partially open position), your vehicle may demonstrate a wind buffeting or pulsation noise. This noise is a normal occurrence and can be reduced or eliminated by taking the following actions. If the noise occurs with one or both of the rear windows down, partially lower both front windows approximately 2.5 cm (1 inch). If you experience the noise with the sunroof open, slightly reduce the size of the sunroof opening.

**⚠ WARNING**

Do not install any accessories in the area of windows. It may impact jam protection.

**Window opening and closing**

You can open and close windows using the power window switch.

**Type A**



To open or close a window, press down or pull up the front portion of the corresponding switch to the first detent position (5).

**Type B - Auto down window (if equipped)**

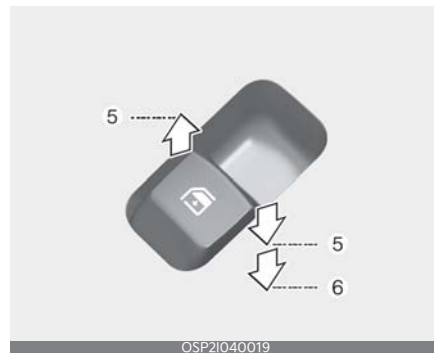

4

Pressing the power window switch momentarily to the second detent position (6) completely lowers the window even when the switch is released. To stop the window at the desired position whilst the window is in operation, pull up the switch briefly to the opposite direction of the window movement.

### Type C - Auto up/down window (if equipped)



Pressing or pulling up the power window switch momentarily to the second detent position (6) completely lowers or raises the window even when the switch is released. To stop the window at the desired position whilst the window is in operation, pull up or press down and release the switch.

If the power window does not operate normally, the automatic power window system must be reset as follows:

1. Turn the ignition switch to the ON position.
2. Close the window and continue pulling up the power window switch for at least 1 second after the window is completely closed.

### Automatic reversal (for Auto up/down window)



If the upward movement of the window is blocked by an object or part of the body, the window will detect the resistance and will stop upward movement. The window will then lower approximately 30 cm (11.8 inches) to allow the object to be cleared.

If the window detects the resistance whilst the power window switch is pulled up continuously, the window will stop upward movement then lower approximately 2.5 cm (1 inch).

And if the power window switch is pulled up continuously again within 5 seconds after the window is lowered by the automatic window reversal feature, the automatic window reversal will not operate.

#### \* NOTICE

The automatic reverse feature for the window is only active when the "auto up" feature is used by fully pulling up the switch. The automatic reverse feature will not operate if the window is raised using the halfway position on the power window switch.

**⚠ WARNING**

Always check for obstructions before raising any window to avoid injuries or vehicle damage. If an object less than 4 mm (0.16 of an inch) in diameter is caught between the window glass and the upper window channel, the automatic reverse window may not detect the resistance and will not stop and reverse direction.

**⚠ WARNING**

The automatic reverse feature is not activated whilst resetting power window system.

Make sure body parts or other objects are safely out of the way before closing the windows to avoid injuries or vehicle damage.

**Power window lock button**

The driver can disable the power window switches on the rear passengers' doors by pressing the power window lock button to the lock position (pressed).



When the power window lock button is pressed:

- The driver's master control can operate all passengers' power windows.
- The front passenger's control can operate the front passenger's power window.
- The rear passengers' control cannot operate the rear passenger's power window.

**⚠ CAUTION**

- To prevent possible damage to the power window system, do not open or close two windows or more at the same time. This will also ensure the longevity of the fuse.
- Never try to operate the main switch on the driver's door and the individual door window switch in opposite directions at the same time. If this is done, the window will stop and cannot be opened or closed.



4

**⚠ WARNING**

**Windows**

- NEVER leave the keys in your vehicle with unsupervised children, when the engine is running.
- NEVER leave any child unattended in the vehicle. Even very young children may inadvertently cause the vehicle to move, entangle themselves in the windows, or otherwise injure themselves or others.
- Always double check to make sure all arms, hands, head and other obstructions are safely out of the way before closing a window.



- Do not allow children play with the power windows. Keep the driver's door power window lock button in the LOCK position (pressed). Serious injury can result from unintentional window operation by the child.
- Do not extend heads or any limbs outside the window whilst the vehicle is in motion.

## Bonnet

The bonnet serves as a cover for the engine compartment.

Open the bonnet if maintenance work needs to be performed in the engine compartment or if you need to look at the compartment.

### Opening the bonnet

1. Pull the release lever to unlatch the bonnet. The bonnet should pop open slightly.



### **⚠ WARNING**

Open the bonnet after turning off the engine on a flat surface, shifting the shift lever to the P (Park) position for Automatic Transmission/Intelligent Variable Transmission and to the 1st (First) gear or R (Reverse) for Manual Transmission/Intelligent Manual Transmission, and setting the parking brake.

2. Go to the front of the vehicle, raise the bonnet slightly, push the secondary bonnet release lever (1) up side and lift the bonnet (2).

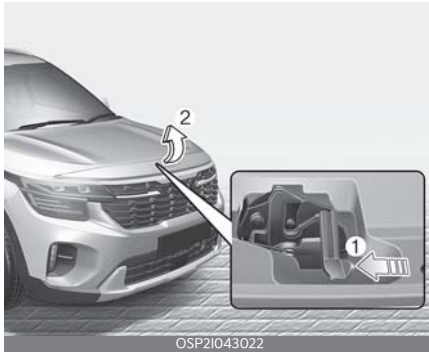

3. Pull out the support rod.



4. Hold the bonnet opened with the support rod.

### Bonnet open warning

The bonnet warning message will appear on the LCD display when bonnet is open.



The warning chime will operate when the vehicle is being driven at or above 3 km/h (2 mph) with the bonnet open.

### Closing the bonnet

1. Before closing the bonnet, check the following:
  - All filler caps in the engine compartment must be correctly installed.
  - Gloves, rags or any other combustible material must be removed from the engine compartment.
2. Lower the bonnet until it is about 30 cm above the closed position and let it drop. Make sure that it locks into place.
3. Check that the bonnet has engaged properly.
  - If the bonnet can be raised slightly, it is not properly engaged.
  - Open it again and close it with a little more force.

**⚠ WARNING**

- Before closing the bonnet, ensure that all obstructions are removed from the bonnet opening. Closing the bonnet with an obstruction present in the bonnet opening may result in property damage or severe personal injury.
- Do not leave gloves, rags or any other combustible material in the engine compartment. Doing so may cause a heat-induced fire.

**⚠ WARNING**

- Always double check to be sure that the bonnet is firmly latched before driving away. If it is not latched, the bonnet could open whilst the vehicle is being driven, causing total loss of visibility, which might result in an accident.
- Do not move the vehicle with the bonnet raised. The view will be blocked and the bonnet could fall or be damaged.

**Fuel filler door**

The vehicle's fuel filler door must be opened and closed by hand from outside the vehicle.

**Opening the fuel filler door**

The fuel filler door must be opened from inside the vehicle by pulling up on the fuel filler door opener located on the front floor area on the driver's seat.

**\* NOTICE**

If the fuel filler door does not open because ice has formed around it, tap lightly or push on the door to break the ice and release the door. Do not pry on the door. If necessary, spray around the door with an approved de-icer fluid (do not use radiator anti-freeze) or move the vehicle to a warm place and allow the ice to melt.

**⚠ WARNING**

Before refuelling, be sure to check what type of fuel is used for your vehicle.

If you put diesel fuel into a petrol-powered vehicle or petrol into a diesel-powered vehicle, it may affect the fuel system and cause serious damage to the vehicle.

1. Stop the engine.
2. To open the fuel filler door, pull up the fuel filler door opener.

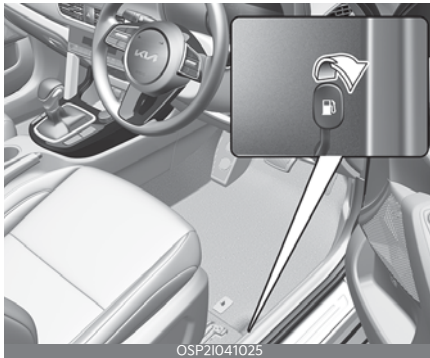

3. Pull open the fuel filler door (1).

Petrol

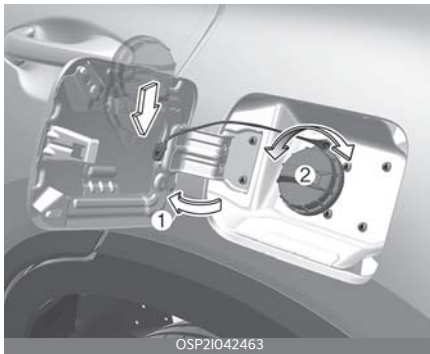

Diesel

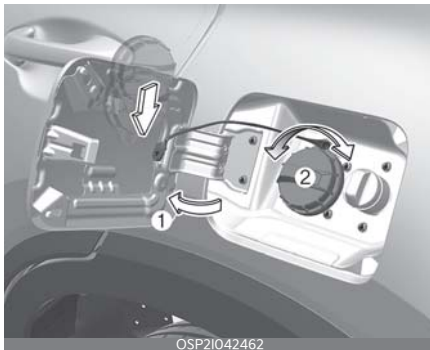

4. To remove the cap, turn the fuel filler cap counterclockwise (2).

5. Refuel as needed.

### Closing the fuel filler door

1. To install the cap, turn it clockwise until it "clicks". This indicates that the cap is securely tightened.
2. Close the fuel filler door and push it lightly and make sure that it is securely closed.

#### **⚠ WARNING**

#### Refuelling

- If pressurized fuel sprays out, it can cover your clothes or skin and thus subject you to the risk of fire and burns. Always remove the fuel cap carefully and slowly. If the cap is venting fuel or if you hear a hissing sound, wait until the condition stops before completely removing the cap.
- Do not "top off" after the nozzle automatically shuts off when refuelling.
- Always check that the fuel cap is installed securely to prevent fuel spillage in the event of an accident.

#### **⚠ WARNING**

#### Refuelling dangers

Automotive fuels are flammable materials. When refuelling, please note the following guidelines carefully. Failure to follow these guidelines may result in severe personal injury, severe burns or death by fire or explosion.

- Read and follow all warnings at the gas station facility.
- Before refuelling note the location of the Emergency Petrol Shut-Off, if available, at the gas station facility.
- Before touching the fuel nozzle, you should eliminate potentially dangerous static electricity discharge by touching another metal part of the vehicle, a safe distance away from the



4

fuel filler neck, nozzle, or other gas source.

- Do not get back into a vehicle once you have begun refuelling since you can generate static electricity by touching, rubbing or sliding against any item or fabric (polyester, satin, nylon, etc.) capable of producing static electricity. Static electricity discharge can ignite fuel vapours resulting in rapid burning. If you must re-enter the vehicle, you should once again eliminate potentially dangerous static electricity discharge by touching a metal part of the vehicle, away from the fuel filler neck, nozzle or other petrol source.
- When using an approved portable fuel container, be sure to place the container on the ground prior to refuelling. Static electricity discharge from the container can ignite fuel vapours causing a fire. Once refuelling has begun, contact with the vehicle should be maintained until the filling is complete.  
Use only approved portable plastic fuel containers designed to carry and store petrol.
- Do not use mobile phones whilst refuelling. Electric current and/or electronic interference from mobile phones can potentially ignite fuel vapours causing a fire.
- When refuelling, always shut the engine off. Sparks produced by electrical components related to the engine can ignite fuel vapours causing a fire. Once refuelling is complete, check to make sure the filler cap and filler door are securely closed, before starting the engine.

- DO NOT use matches or a lighter and DO NOT SMOKE or leave a lit cigarette in your vehicle whilst at a gas station especially during refuelling. Automotive fuel is highly flammable and can result in fire when ignited.
- If a fire breaks out during refuelling, leave the vicinity of the vehicle, and immediately contact the manager of the gas station and then contact the local fire department. Follow any safety instructions they provide.

#### **CAUTION**

- Make sure to refuel your vehicle according to the "Fuel requirements" on page 1-2.
- If the fuel filler cap requires replacement, use only Kia Genuine Parts or those of an equivalent standard for your vehicle. An incorrect fuel filler cap can result in a serious malfunction of the fuel system or emission control system. For more detailed information, we recommend that you contact an authorised Kia dealer/service partner.
- Do not spill fuel on the exterior surfaces of the vehicle. Any type of fuel spilled on painted surfaces may damage the paint.
- After refuelling, make sure the fuel cap is installed securely to prevent fuel spillage in the event of an accident.

## Panorama sunroof (if equipped)

If your vehicle is equipped with a sunroof, you can slide or tilt your sunroof with the sunroof switch located on the overhead console.



The sunroof can only be operated when the Engine Start/Stop button is in the ON or START position.

The sunroof can be operated for approximately 10 minutes after the Engine Start/Stop button is in the ACC or OFF position. However, if the front door is open, the sunroof cannot be operated even within the 10 minute period.

### **⚠ WARNING**

- Adjust the sunroof or sunshade when your vehicle stops. This could result in loss of control and an accident that may cause injury, or property damage.
- Do not leave the engine running and the key in your vehicle with unsupervised children. Unattended children could operate the sunroof, which could result in serious injury.
- Do not sit on the top of the vehicle. It may cause injury or vehicle damage.

### **\* NOTICE**

Do not operate the sunroof when roof bars are installed on the vehicle or when there is luggage on the roof.

## Power sunshade



Use the power sunshade to block direct sunlight coming through the sunroof glass.

- Push the sunroof switch rearward to the first detent position, the power sunshade automatically slides open.
- Push the sunroof switch forward to the first detent position, the power sunshade automatically closes. However, if the sunroof glass is open, the glass will close first.

To stop the power sunshade at any point, push the sunroof switch in any direction.

### **\* NOTICE**

- Do not pull or push the power sunshade by hand as such action may damage the power sunshade or cause it to malfunction.
- Wrinkles formed on the power sunshades are normal due to material characteristic.

### Tilt open/close

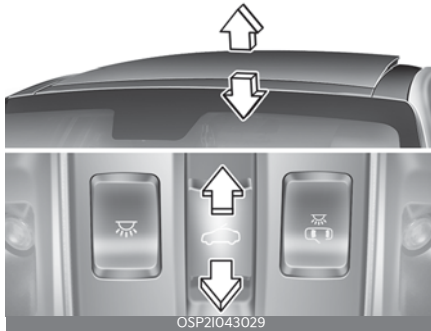

- Push the sunroof switch upward, the sunroof glass tilts open. However, if the power sunshade is close, the sunshade will open first.
- Push the sunroof switch forward, the sunroof glass automatically closes.

To stop the sunroof movement at any point, push the sunroof switch in any direction.

### Slide open/close



- Push the sunroof switch rearward, the sunroof glass slides open. However, if the power sunshade is close, the power sunshade will open first.

Push the sunroof switch forward, the sunroof glass closes.

- Push the sunroof switch forward or rearward to the first detent position, the sunroof glass moves until the switch is released.
- Push the sunroof switch forward or rearward to the second detent position, the sunroof glass operates automatically (auto slide feature).

To stop the sunroof movement at any point, push the sunroof switch in any direction.

### Automatic reversal

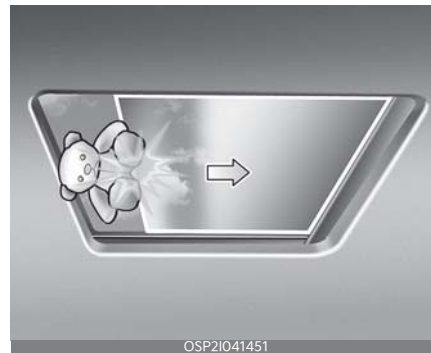

If the power sunroof glass senses any obstacle while it is closing automatically, it will reverse direction then stop at a certain position.

The auto reverse function may not work if an object thin or soft is caught between the sliding power sunshade or sunroof glass and sunroof sash.

### ⚠ WARNING

- Make sure heads, hands, arms or any other body parts or objects are out of the way before operating the sunroof. Body parts or objects may get caught causing injuries or vehicle damage.

- Never deliberately use your body parts to test the automatic reversal function. The power sunshade or sunroof glass may reverse direction, but there is a risk of injury.

### \* NOTICE

- Do not continue to push the sunroof switch after the sunroof is fully opened, closed, or tilted. Damage to the sunroof motor could occur.
- Continuous operations such as slide open/close, tilt open/close, etc. may cause the motor or sunroof system to malfunction.
- Regularly remove any accumulated dust on the sunroof rail.
- Using the sunroof for a long time can make noise caused by dust in accumulated between the sunroof and vehicle body. Open the sunroof and remove dust regularly using a clean cloth.
- Do not try to open the sunroof when the temperature is below freezing or when the sunroof is covered with snow or ice, otherwise the motor could be damaged. In cold and wet climates, the sunroof may not work properly.
- Do not open or drive with the sunroof glass open immediately after rain or washing the vehicle. Water may wet the interior of the vehicle.
- Do not extend any luggage outside the sunroof while driving. Vehicle damage may occur if the vehicle suddenly stops.

### ▲ WARNING

Do not extend your head, arms, body parts or objects outside the sunroof

while driving. Injuries may occur if the vehicle suddenly stops.

## Resetting the sunroof



In some circumstances resetting the sunroof operation may need to be performed. Some instances where resetting the sunroof may be required include:

- When the 12-volt battery is either disconnected or discharged
- When the sunroof fuse is replaced
- If the sunroof one-touch AUTO OPEN/CLOSE operation is not functioning properly

## Sunroof resetting procedure

1. It is recommended to perform the reset procedure with the vehicle engine running. Start the vehicle in P (Park).
2. Make sure the power sunshade and sunroof glass are in the fully closed position. If the power sunshade and sunroof glass are open, push the switch forward until the sunshade and sunroof glass are fully closed.
3. Release the switch when the power sunshade and sunroof glass are fully closed.



4. Push the switch forward until the power sunshade and sunroof glass moves slightly. Then release the switch.
5. Once again push and hold the sunroof switch forward until the sunroof glass slides open and close. Do not release the switch until the operation is completed.

If you release the switch during operation, start the procedure again from step 2.

#### \* NOTICE

If the sunroof is not reset when the vehicle battery is disconnected or discharged, or the sunroof fuse is blown, the sunroof may not operate normally.

#### ⚠ CAUTION

Make sure the sunroof is closed fully when leaving your vehicle. If the sunroof is left open, rain or snow may wet the interior of the vehicle. Also, leaving the sunroof open when the vehicle is unattended may invite theft.

### Sunroof open warning

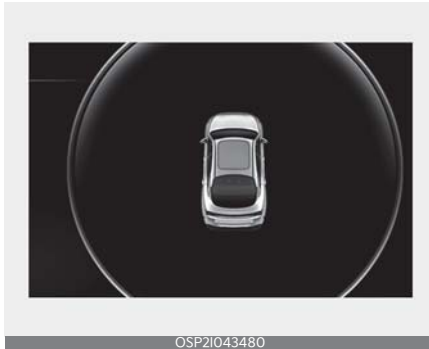

If the driver turns off the engine when the sunroof is not fully closed, the warning chime will sound for several seconds and the sunroof open warning will appear on the cluster LCD display.

Close the sunroof securely when leaving your vehicle.

## Steering wheel

The steering wheel of this vehicle is equipped with the Motor Driven Power Steering (MDPS).

### Motor Driven Power Steering (MDPS)

Power steering uses the motor to assist you in steering the vehicle.

If the engine is off or if the power steering system becomes inoperative, the vehicle may still be steered, but it will require increased steering effort.

The MDPS is controlled by the power steering control unit which senses the steering wheel torque and vehicle speed to command the motor.

The steering effort becomes heavier as the vehicle's speed increases and becomes lighter as the vehicle's speed decreases for better control of the steering wheel.

Should you notice any change in the effort required to steer during normal vehicle operation, have the system checked by a professional workshop. Kia recommends to visit an authorised Kia dealer/service partner.

#### \* NOTICE

The following symptoms may occur during normal vehicle operation:

- The MDPS warning light does not illuminate.
- The steering effort is high immediately after turning the ignition switch on. This happens as the MDPS system performs the diagnostics. When the diagnostics is completed, the steering effort will return to its normal condition.
- A click noise may be heard from the MDPS relay after the ignition switch is turned to the ON or LOCK position.
- Motor noise may be heard when the vehicle is at a stop or at a low driving speed.
- When the abnormality is detected in the electric power steering system, a deadly accident prevention purposes, steering assist functions will be stopped. At this time, the instrument panel warning light turns on or blinks and the power to manipulate the steering will be off. Please check immediately after moving the vehicle to a safe zone.
- The steering effort increases if the steering wheel is rotated continuously when the vehicle is not in motion. However, after a few minutes, it will return to its normal conditions.
- If the Motor Driven Power Steering System does not operate normally, the warning light will illuminate on the instrument cluster. The steering wheel may become difficult to control or operate abnormally. In this case, have the system inspected by a professional workshop. Kia recommends to visit an authorised Kia dealer/service partner.

- When you operate the steering wheel in low temperature, abnormal noise could occur. If temperature rises, the noise will disappear. This is a normal condition.

### Tilt & telescopic steering wheel

A tilt and telescopic steering wheel allows you to adjust the steering wheel before you drive. You can also raise it to give your legs more room when you exit and enter the vehicle.

The steering wheel should be positioned so that it is comfortable for you to drive, whilst permitting you to see the instrument panel warning lights and gauges.

#### **⚠ WARNING**

- Never adjust the angle of the steering wheel whilst driving. You may lose steering control and cause severe personal injury, death or accidents.
- After adjusting, push the steering wheel both up and down to be certain it is locked in position.

2. Adjust the steering wheel to the desired angle (2) and height (3, if equipped).
3. Pull up the lock-release lever to lock the steering wheel in place.
4. Be sure to adjust the steering wheel to the desired position before driving.

#### **\* NOTICE**

After adjustment, sometimes the lock-release lever may not lock the steering wheel.

It is not a malfunction. This occurs when two gears engage. In this case, adjust the steering wheel again and then lock the steering wheel.

### Adjusting steering wheel angle and height

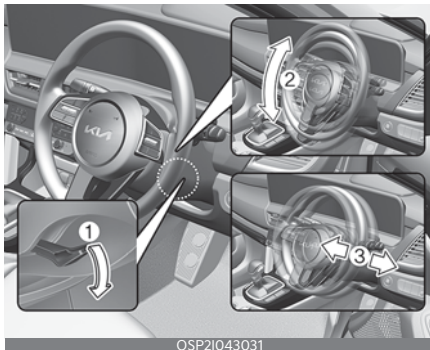

1. To change the steering wheel angle, pull down the lock release lever (1).

## Horn

To sound the horn, press the area indicated by the horn symbol on your steering wheel (see illustration).



The horn will operate only when this area is pressed. Check the horn regularly to be sure it operates properly.

### ⚠ CAUTION

- Do not strike the horn severely to operate it, or hit it with your fist. Do not press on the horn with a sharp-pointed object.
- When cleaning the steering wheel, do not use an organic solvent such as thinner, benzene, alcohol and petrol. Doing so may damage the steering wheel.

## Mirrors

This vehicle is equipped with inside and outside rearview mirrors to provide views of objects behind the vehicle.

### Inside rearview mirror

Adjust the rearview mirror so that the centre view through the rear window is seen.

Make this adjustment before you start driving.

### ⚠ WARNING

#### Rear visibility

Do not place objects in the rear seat or cargo area which would interfere with your vision out the rear window.

### ⚠ WARNING

Do not adjust the rearview mirror whilst the vehicle is moving. This could result in loss of control, and an accident which could cause death, serious injury or property damage.

### ⚠ WARNING

Do not modify the inside mirror and don't install a wide mirror. It could result in injury, during an accident or deployment of the air bag.

## Day/night rearview mirror (if equipped)



(1): Day, (2): Night

Make this adjustment before you start driving and whilst the day/night lever is in the day position (1).

Pull the day/night lever toward you (2) to reduce the glare from the headlights of the vehicles behind you during night driving.

Remember that you lose some rearview clarity in the night position.

## Electric Chromic Mirror (ECM) with Kia Connect service (if equipped)

The electric rearview mirror automatically controls the glare from the headlights of the vehicles behind you in nighttime or low light driving conditions.



1. SOS Button
2. Roadside assist button
3. Virtual assist button (Kia Connect)
4. Sensor

The sensor (4) mounted in the mirror senses the light level around the vehicle, and automatically controls the headlight glare from the vehicles behind you.

When the engine is running, the glare is automatically controlled by the sensor mounted in the rearview mirror.

Telematics buttons are also located on the mirror.

## Outside rearview mirror

Your vehicle is equipped with both left-hand and right-hand outside rearview mirrors.

Be sure to adjust the mirror angles before driving.

The mirrors can be adjusted remotely with the control levers or remote switch, depending on the type of mirror control installed. The mirror heads can be folded back to prevent damage during an automatic car wash or when passing through a narrow street.

**⚠ WARNING****Rearview mirrors**

- The outside rearview mirror is convex. Objects seen in the mirror are closer than they appear.
- Use your interior rearview mirror or direct observation to determine the actual distance of following vehicles when changing lanes.

**⚠ CAUTION**

Do not scrape ice off the mirror face; this may damage the surface of the glass. If ice should restrict the movement of the mirror, do not force the mirror for adjustment. To remove ice, use a deicer spray, or a sponge or soft cloth with warm water.

**⚠ CAUTION**

If the mirror is jammed with ice, do not adjust the mirror by force. Use an approved spray de-icer (not radiator antifreeze) to release the frozen mechanism or move the vehicle to a warm place and allow the ice to melt.

**⚠ WARNING**

Do not adjust or fold the outside rearview mirrors whilst the vehicle is moving. This could result in loss of control, and an accident which could cause death, serious injury or property damage.

**Adjusting the outside rearview mirrors****Manual type (if equipped)**

OSP21049097

To adjust an outside mirror, move the control lever located at the forward inside area of the window frame.

**Electric type (if equipped)**

The electric remote control mirror switch allows you to adjust the position of the left and right outside rearview mirrors.

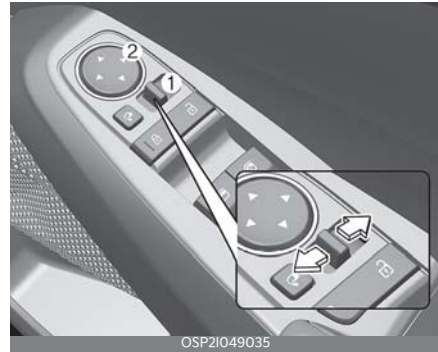

OSP21049035

Adjusting the rearview mirrors:

1. Move the R or L switch (1) to select the right side mirror or the left side mirror.
2. Press a corresponding point (▲) on the mirror adjustment control (2) to

position the selected mirror up, down, left or right.

### ⚠ CAUTION

- The mirrors stop moving when they reach the maximum adjusting angles, but the motor continues to operate whilst the switch is pressed. Do not press the switch longer than necessary, the motor may be damaged.
- Do not attempt to adjust the outside rearview mirror by hand. Doing so may damage the parts.

## Folding the outside rearview mirror

### Manual type (if equipped)



To fold the outside rearview mirror:

- Grasp the housing of the mirror and then fold it toward the rear of the vehicle.

### Electric type (if equipped)

The outside rearview mirror can be folded or unfolded by pressing the switch when the ignition switch or ENGINE START/STOP button is in the ON position as below.



- To fold the outside rearview mirror depress the button (1).
- To unfold it, depress the button (1) again.

### ⚠ CAUTION

The electric type outside rearview mirror operates even though the ignition switch or ENGINE START/STOP button is in the LOCK or OFF position. However, to prevent unnecessary battery discharge, do not adjust the mirrors longer than necessary whilst the engine is not running.

### ⚠ CAUTION

In case it is an electric type outside rearview mirror, don't fold it by hand. It could cause motor failure.

## Instrument cluster

Type A



Type B



\* The actual cluster in the vehicle may differ from the illustration.

1. Speedometer
2. Tachometer
3. Fuel gauge
4. Engine coolant temperature gauge
5. LCD display
6. Warning and indicator lights



## Instrument cluster (if equipped)

The Type B cluster provides two themes.

### Theme A/B/C

Theme A/B/C is the basic theme of the full LCD type cluster and provides different graphic styles depending on drive mode.



### Dynamic Theme

Dynamic Theme is set by the user and provides digital display. The background screen changes according to the weather and time.



- Weather: clear, cloudy, rainy, snowy, foggy, lightning, clear up (7 types)
- Time: night, day, sunrise and sunset (4 types)

You can change the theme by selecting "Vehicle → Cluster → Theme Selection" on the menu.

**⚠ CAUTION**

The information is displayed after getting information from a weather information provider via GPS. Depending on conditions of GPS reception, the information may be different from the current weather in your area.

If no information is received via GPS (e.g., not subscribed to Kia Connect service), the weather and time will be displayed as 'sunny' and 'night' on the cluster.

**Gauges**

The gauges display various information such as the speed of the vehicle, and so on.

**Speedometer**



The speedometer indicates the speed of the vehicle and is calibrated in kilometers per hour (km/h).



4

**Tachometer**

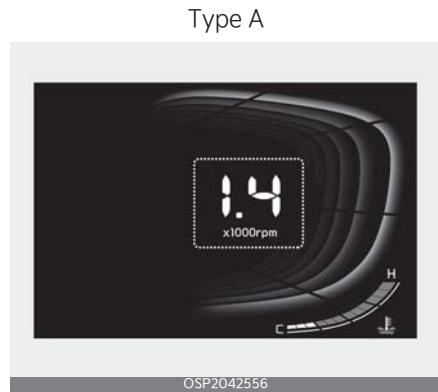

Type B



ODL3042156

The tachometer indicates the approximate number of engine revolutions per minute (rpm).

Use the tachometer to select the correct shift points and to prevent lugging and/or over-revving the engine.

**CAUTION**

Do not operate the engine within the tachometer's RED ZONE. This may cause severe engine damage.

**Engine coolant temperature gauge**

Type A



OSP2042555

Type B



ODL3042157

This gauge indicates the temperature of the engine coolant when the ignition switch or ENGINE START/STOP button is ON.

**CAUTION**

If the gauge pointer moves beyond the normal range area (between the C-H) toward the "H" position, it indicates overheating that may damage the engine.

Do not continue driving with an overheated engine. If your vehicle overheats, refer to "If the engine overheats" on page 7-7.

**WARNING**

Never remove the radiator cap when the engine is hot. The engine coolant is under pressure and could severely burn. Wait until the engine is cool before adding coolant to the reservoir.

## Fuel gauge

Type A



Type B



This gauge indicates the approximate amount of fuel remaining in the fuel tank.

### \* NOTICE

- The fuel tank capacity is given in "Recommended lubricants and capacities" on page 9-10.
- The fuel gauge is supplemented by a low fuel warning light, which will illuminate when the fuel tank is nearly empty.
- On inclines or curves, the fuel gauge pointer may fluctuate or the low fuel warning light may come on earlier

than usual due to the movement of fuel in the tank.

### ⚠ WARNING

#### Fuel Gauge

Running out of fuel can expose vehicle occupants to danger.

You must stop and obtain additional fuel as soon as possible after the warning light comes on or when the gauge indicator comes close to the "E" level.

### ⚠ CAUTION

Avoid driving with an extremely low fuel level. Running out of fuel could cause the engine to misfire damaging the catalytic converter.

4

## Odometer

Type A

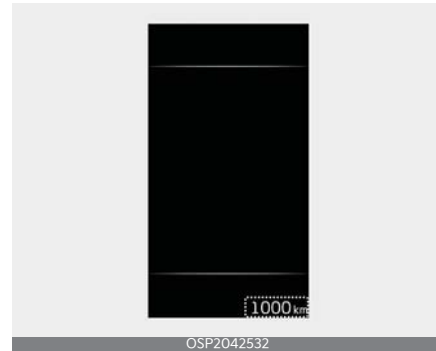

Type B



ODL3042111

The odometer Indicates the total distance that the vehicle has been driven and should be used to determine when periodic maintenance should be performed.

- Odometer range: 0 ~ 1,599,999 km or 999,999 miles.

### Distance to empty

Type A

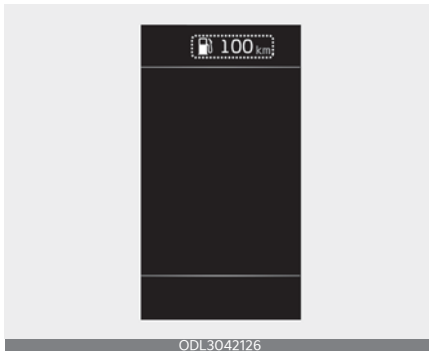

ODL3042126

Type B



OSP2042550

- The distance to empty is the estimated distance the vehicle can be driven with the remaining fuel.
  - Distance range: 1 ~ 9,999 km
- If the estimated distance is below 1 km, the trip computer will display "----" as distance to empty.
- If the level of the remaining fuel is more than three-quarters, more than 3 litres of fuel must be refilled for the fuel gauge to change. In other cases, more than 6 litres of fuel must be refilled for the vehicle to change the fuel gauge.

### \* NOTICE

- If the vehicle is not on level ground or the battery power has been interrupted, the distance to empty function may not operate correctly.
- The distance to empty may differ from the actual driving distance as it is an estimate of the available driving distance.
- The trip computer may not register additional fuel if less than 6 litres of fuel are added to the vehicle.
- The fuel economy and distance to empty may vary significantly based

on driving conditions, driving habits, and condition of the vehicle.

### Outside temperature gauge

Type A



Type B



This gauge indicates the current outside air temperatures by 1 °C (1 °F).

- Temperature range: -40 °C ~ 85 °C (-40 °F ~ 211 °F)

The outside temperature on the display may not change immediately like a general thermometer to prevent the driver from being inattentive.

To change the temperature unit (from °C to °F or from °F to °C)

The temperature unit can be changed by using the "User Settings" mode of the LCD Display.

\* For more details, refer to "LCD display" on page 4-49.

### Transmission shift indicator

Transmission shift indicator displays gear information depending on your vehicle's transmission type.

### Automatic transmission/intelligent variable transmission shift indicator (if equipped)

Type A

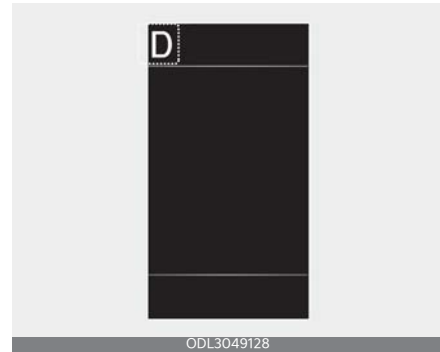

Type B



This indicator displays which automatic transmission shift lever is selected.

- Park: P



4

- Reverse: R
- Neutral: N
- Drive: D
- Sports Mode: 1, 2, 3, 4, 5, 6

**Manual Transmission/Intelligent Manual Transmission shift indicator (if equipped)**

▼4: Indicates that shifting down to the 4th gear is desired (currently the shift lever is in the 5th or 6th gear).  
When the system is not working properly, the indicator is not displayed.

Type A



Type B



This indicator informs which gear is desired whilst driving to save fuel.

- Shifting up: ▲2, ▲3, ▲4, ▲5, ▲6
- Shifting down: ▼1, ▼2, ▼3, ▼4, ▼5

For example



▲3: Indicates that shifting up to the 3rd gear is desired (currently the shift lever is in the 2nd or 1st gear).

## LCD display

The LCD display modes can be changed by using the control buttons.

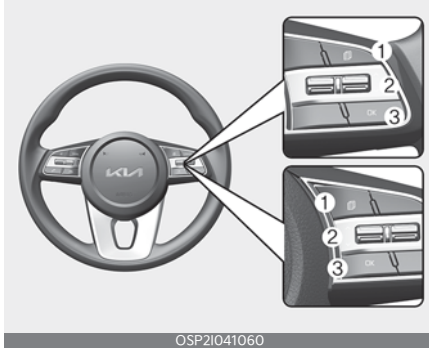
### LCD Display Control









1. : MODE button for changing modes
2. : MOVE switch for changing items
3. OK: SELECT/RESET button for setting or resetting the selected item

4



### LCD display modes

The LCD display provides 5 modes. You can switch modes by pressing the Mode button.

Mode						
	 Driving Assist	 Trip Computer	 Turn By Turn (TBT)*	 User settings <sup>1</sup>	 Information	 Master warning
 Up/Down	Lane Keeping Assist*/Smart Cruise Control*/Lane Following Assist*	Drive info	Route Guidance	Driver assistance	Tyre Pressure*	The Master Warning mode displays warning messages related to the vehicle when one or more systems is not operating normally.
		Since refuelling	Destination Info	Head-up display*		
	Accumulated info	Cluster				
	Digital Speedometer <sup>2</sup>	Lights				
		Door				
		Convenience				
		Unit				
		Language				
	Reset					

The information provided may differ depending on which functions are applicable to your vehicle.

\*: if equipped

\* 1: for Type A cluster

\* 2: for Type B cluster

#### \* NOTICE

Keep the engine running when configuring the display settings to prevent the battery from discharging.

### Driving Assist mode



This mode displays the state of:

- Lane Keeping Assist (if equipped)
- Smart Cruise Control (if equipped)
- Lane Following Assist (if equipped)

\* For more details, refer to each system information in "Lane Keeping Assist (LKA) (if equipped)" on page 6-17, "Smart Cruise Control (SCC) (if equipped)" on page 6-52, "Lane Following Assist (LFA) (if equipped)" on page 6-66.

### Trip computer mode



The trip computer mode displays information related to vehicle driving parameters including fuel economy, tripmeter information and total driving time.

\* For more details, refer to "Trip information (trip computer)" on page 4-57.

### Turn By Turn (TBT) mode (if equipped)



This mode displays the state of the navigation.

### Information mode

#### Tyre Pressure (if equipped)



This mode displays information related to Tyre Pressure.

\* For more details, refer to "Tyre Pressure Monitoring System (TPMS)" on page 7-8.



4

## Master warning mode



This warning light informs the driver the following situations.

- Forward Collision-Avoidance Assist malfunction\*
- Forward Collision-Avoidance Assist radar blocked\*
- Blind-Spot Collision-Avoidance Assist malfunction\*
- Blind-Spot Collision-Avoidance Assist radar blocked\*
- High Beam Assist malfunction\*
- Smart Cruise Control malfunction\*
- Smart Cruise Control radar blocked\*
- LED headlamp malfunction\*
- Lamp malfunction, etc.

At this time, a Master Warning icon (⚠) will appear on the LCD display.

If the warning situation is solved, the master warning light will be turned off and the Master Warning icon will disappear.

\* : if equipped

## User settings mode (if equipped)

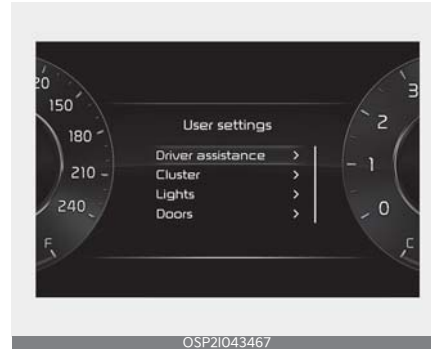

In this mode, you can change the settings of the instrument cluster, doors, lamps, etc.

1. Driver assistance
2. Head-up display
3. Cluster
4. Lights
5. Door
6. Convenience
7. Unit
8. Language
9. Reset

The information provided may differ depending on which functions are applicable to your vehicle.

### 1. Driver assistance (if equipped)

Items	Explanation
Driving convenience	Smart Cruise Control (SCC) * For more details, refer to "Smart Cruise Control (SCC) (if equipped)" on page 6-52.
Warning volume	<ul style="list-style-type: none"> <li>• High/Medium/Low</li> </ul> To select the Warning volume.
DAW (Driver Attention Warning)	<ul style="list-style-type: none"> <li>• Leading vehicle departure alert</li> </ul> To select the function. * For more details, refer to "Driver Attention Warning (DAW) (if equipped)" on page 6-40.
Driving safety	<ul style="list-style-type: none"> <li>• Forward safety</li> <li>• Forward Safety Warning Timing - Late/Normal</li> </ul> To select the function. * For more details, refer to "Forward Collision-Avoidance Assist (FCA) (Sensor fusion) (if equipped)" on page 6-4. <ul style="list-style-type: none"> <li>• Lane safety</li> </ul> To select the function. * For more details, refer to "Lane Keeping Assist (LKA) (if equipped)" on page 6-17. <ul style="list-style-type: none"> <li>• Blind-spot safety</li> </ul> To select the function. * For more details, refer to "Blind-Spot Collision-Avoidance Assist (BCA) (if equipped)" on page 6-24. <ul style="list-style-type: none"> <li>• Safe exit</li> </ul> To select the function. * For more details, refer to "Safe Exit Warning (SEW) (if equipped)" on page 6-33.
Parking safety	<ul style="list-style-type: none"> <li>• Auto PDW (Parking Distance Warning)</li> </ul> To select the function. * For more details, refer to "Forward/Reverse Parking Distance Warning (PDW) (if equipped)" on page 6-93. <ul style="list-style-type: none"> <li>• Rear cross-traffic safety</li> </ul> To select the function. * For more details, refer to "Rear Cross-Traffic Collision-Avoidance Assist (RCCA) (if equipped)" on page 6-80.



4

\* The information provided may differ depending on which systems are applicable to your vehicle.

## 2. Head-up display (if equipped)

Items	Explanation
Enable head-up display	If this item is checked, Head-up display will be activated.
Display height	Adjust the height (1~20) of the HUD image on the HUD screen.
Rotation	Adjust the degree (-5~+5) of the HUD rotation.
Brightness	Adjust the intensity (1~20) of the HUD brightness.
Content selection	If below items are checked, the items will be activated. Turn by turn/Traffic signs/Driving Convenience info/Blind-spot safety info/Radio, Media info

\* The information provided may differ depending on which systems are applicable to your vehicle.

## 3. Cluster (if equipped)

Items	Explanation
Cluster theme	<ul style="list-style-type: none"> <li>Link to drive mode/Theme A/Theme B/Theme C</li> </ul> To select the theme of the instrument cluster.
Wiper/Lights display	To activate or deactivate the wiper/lights display.
Icy road warning	To activate or deactivate the icy road warning.
Welcome sound	To activate or deactivate the welcome sound.

\* The information provided may differ depending on which systems are applicable to your vehicle.

## 4. Lights (if equipped)

Items	Explanation
Illumination	<ul style="list-style-type: none"> <li>Level 1~20</li> </ul> To select the brightness for the instrument panel illumination.
One touch turn indicator	<ul style="list-style-type: none"> <li>Off: The one touch turn indicator function will be deactivated.</li> <li>3, 5, 7 flashes: The turn signal indicator will blink 3, 5, or 7 times when the turn signal lever is moved slightly.</li> </ul> * For more details, refer to "One-touch lane change function" on page 4-80.
Headlight time-out	If this item is checked, the headlight escort function will be activated.
HBA (High Beam Assist)	If this item is checked, High Beam Assist will be activated. * For more details, refer to "High Beam Assist (HBA) (if equipped)" on page 4-81.

\* The information provided may differ depending on which functions are applicable to your vehicle.

## 5. Door (if equipped)

Items	Explanation
Auto lock	<ul style="list-style-type: none"> <li>• Enable on Shift : All doors will be automatically locked if the vehicle is shifted from the P (Park) position to the R (Reverse), N (Neutral), or D (Drive) position (with engine ON, it is activated).</li> <li>• Enable on speed: All doors will be automatically locked when the vehicle speed exceeds 15 km/h (9.3 mph)</li> <li>• Off: The auto door unlock operation will be cancelled.</li> </ul>

\* The information provided may differ depending on which systems are applicable to your vehicle.

## 6. Convenience (if equipped)

Items	Explanation
Service interval	<ul style="list-style-type: none"> <li>• Enable service interval/Adjust interval/Reset</li> </ul>
Welcome lights	<ul style="list-style-type: none"> <li>• On door unlock / On driver approach</li> </ul>
Welcome mirror/lights	<ul style="list-style-type: none"> <li>• On door unlock / On driver approach</li> </ul> To select the welcome mirror function.

\* The information provided may differ depending on which functions are applicable to your vehicle.

## 7. Unit (if equipped)

Items	Explanation
Speedometer unit	<ul style="list-style-type: none"> <li>• km/h or MPH</li> </ul> To select the Speedometer unit.
Temperature unit	<ul style="list-style-type: none"> <li>• °C/°F</li> </ul> To select the Temperature unit.
Fuel economy unit	<ul style="list-style-type: none"> <li>• L/100km, km/L</li> </ul> To select the Fuel economy unit.
Tyre pressure unit	<ul style="list-style-type: none"> <li>• psi, kPa, bar</li> </ul> To select the Tyre pressure unit

\* The information provided may differ depending on which functions are applicable to your vehicle.

## 8. Language

Items	Explanation
Language	To select language.

## 9. Reset

Items	Explanation
Reset	You can reset the menus in the User settings mode. All menus in the User settings mode are reset to factory settings, except language and service interval.

### Trip information (trip computer)

The trip computer is a microcomputer-controlled driver information system that displays information related to driving.

**\* NOTICE**

Some driving information stored in the trip computer resets if the battery is disconnected.

### Trip Modes

Type A

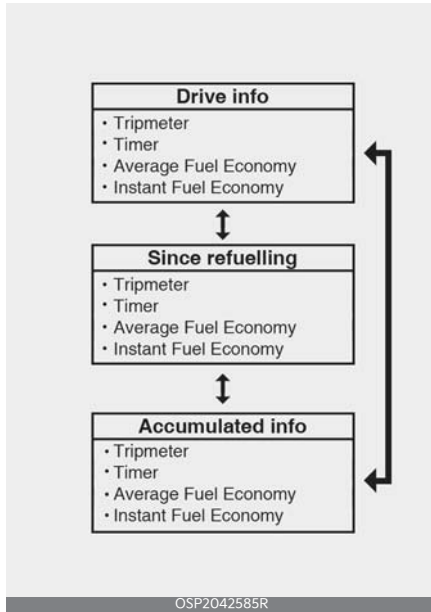

Type B

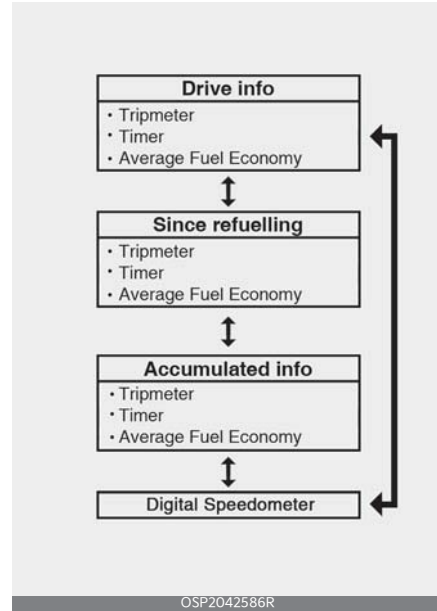

To change the trip mode, scroll the toggle the switch (∧ / ∨) on the steering wheel.



### Drive info mode

This display shows the trip distance (1), the total driving time (2), the average fuel efficiency (3), and the instant fuel economy (4, if equipped) information once per one ignition cycle.

Type A



Type B

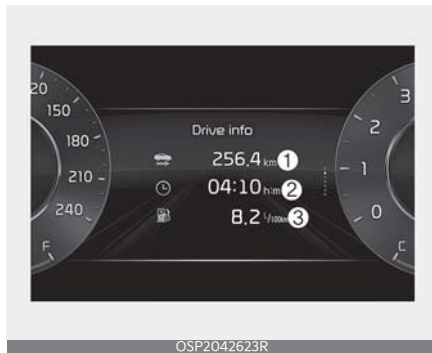

- Fuel efficiency is calculated after the vehicle has run for more than 300 meters (0.2 miles).
- If opening the driver's door after turning off the engine or 3 minutes passes after restarting the engine, Driving Information is reset.
- If you press "OK" button for more than 1 second after the Driving Information

is displayed, the information will be reset.

- If the engine is running, even when the vehicle is not in motion, the information will be accumulated.

### Since refuelling mode

This display shows the trip distance (1), the total driving time (2), the average fuel efficiency (3), and the instant fuel economy (4, if equipped).

Type A

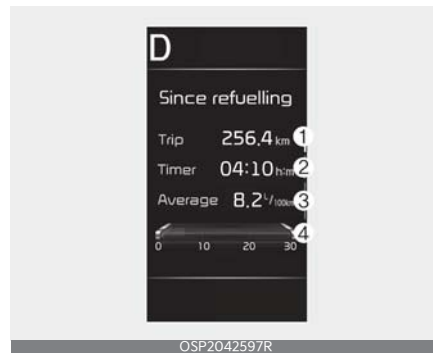

Type B

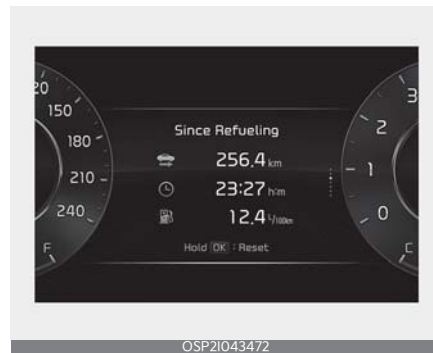

- Fuel efficiency is calculated after the vehicle has run for more than 300 meters (0.2 miles).
- After refuelling more than 6 litres (1.6 gallons) and driving over 1 km/h, the

Since refuelling will reset to default automatically.

- If you press "OK" button for more than 1 second after the Driving Information is displayed, the information will be reset.
- If the engine is running, even when the vehicle is not in motion, the information will be accumulated.

- Accumulated information is calculated after the vehicle has run for more than 300 meters (0.2 miles).
- If you press "OK" button for more than 1 second after the Cumulative Information is displayed, the information will be reset.
- If the engine is running, even when the vehicle is not in motion, the information will be accumulated.

### Accumulated driving information mode

This display shows the accumulated trip distance (1), the total driving time (2), the average fuel efficiency (3), and the instant fuel economy (4, if equipped).

Type A

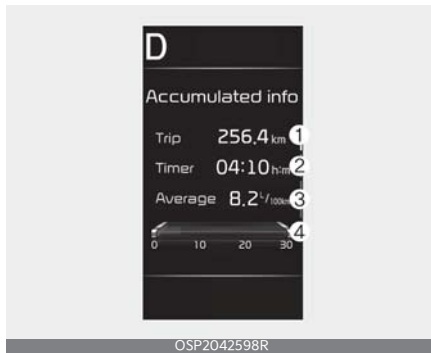

Type B



### Digital speedometer (for Type B cluster)



This mode displays the current speed of the vehicle.



4

## Auto stop (if equipped)



Auto stop display shows the elapsed time of engine stop by Idle Stop and Go (ISG) system. If the ISG does not operate, the reason for the non-operation is displayed. (if equipped)

For more details, refer to "Idle Stop and Go (ISG) system (if equipped)" on page 5-56.

## Urea level gauge (for diesel engine) (if equipped)

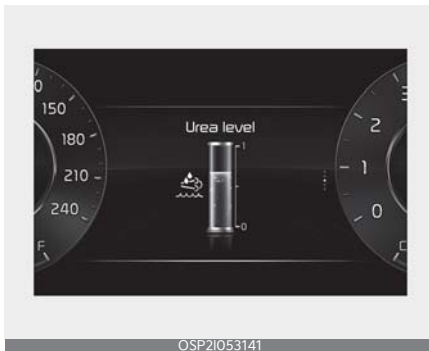

This mode displays the amount of the remaining urea solution in the urea solution tank.

## Service mode

This mode reminds you of scheduled maintenance information.

### Service in

It calculates and displays when you need a scheduled maintenance service (mileage or days).

If the remaining mileage or time reaches 1,500 km (900 miles) or 30 days, "Service in" message is displayed for several seconds each time you set the ignition switch or ENGINE START/STOP button to the ON position.

### Service required

If you do not have your vehicle serviced according to the already inputted service interval, "Service required" message is displayed for several seconds each time you set the ignition switch or ENGINE START/STOP button to the ON position.

To reset the service interval to the mileage and days you inputted before:

- Press the OK button (Reset) for more than 1 second.

### \* NOTICE

If any of the following conditions occurs, the mileage and days may be incorrect.

- The battery cable is disconnected.
- The battery is discharged.

### Service interval

This reminds you of scheduled maintenance information.

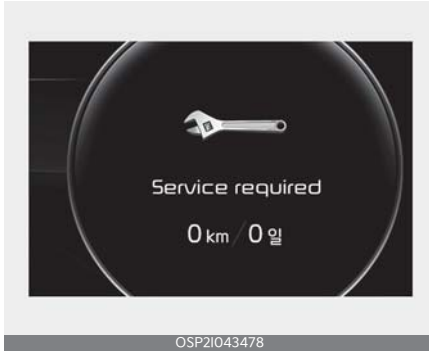

### Service in

It calculates and displays when you need a scheduled maintenance service (mileage or days).

If the remaining mileage or time reaches 1,500 km (900 miles) or 30 days, "Service in" message is displayed for several seconds each time you set the ignition switch or ENGINE START/STOP button to the ON position.

### Service required

If you do not have your vehicle serviced according to the already inputted service interval, "Service required" message is displayed for several seconds each time you set the ignition switch or ENGINE START/STOP button to the ON position.

To reset the service interval to the mileage and days you inputted before:

- Press the OK button (Reset) for more than 1 second.

### \* NOTICE

If any of the following conditions occurs, the mileage and days may be incorrect.

- The battery cable is disconnected.

- The battery is discharged.

### LCD display messages

#### Door, bonnet, tailgate open

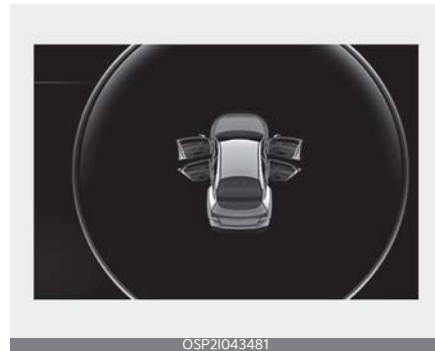

- This warning is displayed indicating which door, the bonnet, the tailgate or the sunroof is open.

#### Sunroof open



This warning is displayed if you turn off the engine when the sunroof is open.

## Lights mode

Type A



OSP21043482

Type B



ODL3049165L

This indicator displays which exterior light is selected using the lighting control.

You can activate or deactivate Wiper/Lights display function from the User settings mode in the cluster LCD display or the Settings in the Infotainment system screen.

## Wiper mode

Type A



OSP21043477

Type B



OSP2042637R

This indicator displays which wiper speed is selected using the wiper control.

You can activate or deactivate Wiper/Lights display function from the User settings mode in the cluster LCD display or the Settings in the Infotainment system screen.

## Low washer fluid

- This warning message illuminates when the washer fluid reservoir is nearly empty.
- It means that you should refill the washer fluid.

### Engine has overheated

- This warning message illuminates when the engine coolant temperature is above 120 °C (248 °F). This means that the engine is overheated and may be damaged.

\* If your vehicle is overheated, refer to "If the engine overheats" on page 7-7.

### Shift to P (for smart key system)

- This warning message illuminates if you try to turn off the engine without the gear in P (Park) position.
- At this time, the ENGINE START/STOP button turns to the ACC position.

### Low key battery (for smart key system)

- This warning message illuminates if the battery of the smart key is discharged when the ENGINE START/STOP button changes to the OFF position.

### Press START button whilst turning wheel (for smart key system)

- This warning message illuminates if the steering wheel does not unlock normally when the ENGINE START/STOP button is pressed.
- It means that you should press the ENGINE START/STOP button whilst turning the steering wheel right and left.

### Check steering wheel lock system (for smart key system)

- This warning message illuminates if the steering wheel does not lock normally when the ENGINE START/STOP button changes to the OFF position.

### Press clutch pedal to start engine (for smart key system and Manual Transmission)

- This warning message illuminates if the ENGINE START/STOP button changes to the ACC position twice by pressing the button repeatedly without depressing the clutch pedal.
- It means that you should depress the clutch pedal to start the engine.

### Key not in vehicle (for smart key system)

- This warning message illuminates if the smart key is not in the vehicle when you press the ENGINE START/STOP button.
- It means that you should always have the smart key with you.

### Key not detected (for smart key system)

- This warning message illuminates if the smart key is not detected when you press the ENGINE START/STOP button.

### Shift to P or N to start engine (for smart key system)

- This warning message illuminates if you try to start the engine with the shift lever not in the P (Park) or N (Neutral) position.

### Press brake pedal to start engine (for smart key system)

- This warning message illuminates if the ENGINE START/STOP button changes to the ACC position twice by pressing the button repeatedly without depressing the brake pedal.

- It means that you should depress the brake pedal to start the engine.

### **12V battery discharging due to additional electrical devices**

The vehicle can detect self-discharge of the battery due to over-current that is generated by unauthorised electrical devices such as dashboard camera (dash cam) mounting during parking.

If the warning continues even after external electrical devices are removed, have your vehicle inspected by a professional workshop. Kia recommends to contact an authorised Kia dealer/service partner.

### **Press START button again (for smart key system)**

- This warning message illuminates if you cannot operate the ENGINE START/STOP button when there is a problem with the ENGINE START/STOP button system.
- It means that you could start the engine by pressing the ENGINE START/STOP button once more.
- If the warning illuminates each time you press the ENGINE START/STOP button, have the vehicle inspected by a professional workshop. Kia recommends to visit an authorised Kia dealer/service partner.

### **Press START button with key (for smart key system)**

- This warning message illuminates if you press the ENGINE START/STOP button whilst the warning message "Key not detected" is illuminating.
- At this time, the immobiliser indicator light blinks.

### **Check BRAKE SWITCH fuse (for smart key system)**

- This warning message illuminates if the brake switch fuse is disconnected.
- It means that you should replace the fuse with a new one. If that is not possible, you can start the engine by pressing the ENGINE START/STOP button for 10 seconds in the ACC position.

## Warning and indicator lights

The warning light and indicator light indicate a situation where the driver should be careful and whether the various functions are activated.

### Warning lights

The warning light indicates situations that require the driver to pay attention.

#### \* NOTICE

### Warning lights

Make sure that all warning lights are OFF after starting the engine. If any light is still ON, this indicates a situation that needs attention.

### Air bag warning light

#### This warning light appears:

- Once you set the ignition switch or ENGINE START/STOP button to the ON position.
  - It appears for approximately 6 seconds and then goes off.
- When there is a malfunction with the SRS.

In this case, have the vehicle inspected by a professional workshop. Kia recommends to visit an authorised Kia dealer/service partner.

### Seat belt warning light

**This warning light informs the driver that the seat belt is not fastened.**

\* For more details, refer to "Seat belts" on page 3-15.

### Parking brake & brake fluid warning light

#### This warning light appears:

- Once you set the ignition switch or ENGINE START/STOP button to the ON position.
  - It appears for approximately 3 seconds
  - It remains on if the parking brake is applied.
- When the parking brake is applied.
- When the brake fluid level in the reservoir is low.
  - If the warning light appears with the parking brake released, it indicates the brake fluid level in reservoir is low.

#### If the brake fluid level in the reservoir is low:

1. Drive carefully to the nearest safe location and stop your vehicle.
2. With the engine stopped, check the brake fluid level immediately and add fluid as required (For more details, refer to "Brake/clutch fluid" on page 8-18). Then check all brake components for fluid leaks. If any leak on the brake system is still found, the warning light remains on, or the brakes do not operate properly, do not drive the vehicle.

In this case, have the vehicle towed to a professional workshop and inspected. Kia recommends to visit an authorised Kia dealer/service partner.

### Dual-diagonal braking system

Your vehicle is equipped with dual-diagonal braking systems. This means you



still have braking on two wheels even if one of the dual systems should fail. With only one of the dual systems working, more than normal pedal travel and greater pedal pressure are required to stop the vehicle.

Also, the vehicle will not stop in as short a distance with only a portion of the brake system working.

If the brakes fail whilst you are driving, shift to a lower gear for additional engine braking and stop the vehicle as soon as it is safe to do so.

### WARNING

#### **Parking Brake & Brake Fluid Warning Light**

Driving the vehicle with a warning light ON is dangerous. If the Parking Brake & Brake Fluid Warning Light appears with the parking brake released, it indicates that the brake fluid level is low.

In this case, have the vehicle inspected by a professional workshop. Kia recommends to visit an authorised Kia dealer/service partner.

#### **Anti-lock brake system (ABS) warning light**

##### **This warning light appears:**

- Once you set the ignition switch or ENGINE START/STOP button to the ON position.
  - It appears for approximately 3 seconds and then goes off.
- When there is a malfunction with the ABS (The normal braking system will still be operational without the assistance of the anti-lock brake system).

In this case, have the vehicle inspected by a professional workshop. Kia recommends to visit an authorised Kia dealer/service partner.

#### **Electronic Parking Brake (EPB) warning light (if equipped)**

##### **This warning light appears:**

- Once you set the ignition switch or ENGINE START/STOP button to the ON position.
  - It appears for approximately 3 seconds and then goes off.
- When there is a malfunction with the EPB.

In this case, have the vehicle inspected by a professional workshop. Kia recommends to visit an authorised Kia dealer/service partner.

\* For more details, refer to "Electronic Parking Brake (EPB) (if equipped)" on page 5-43.

### NOTICE

#### **Electronic Parking Brake (EPB) Warning Light**

The Electronic Parking Brake (EPB) Warning Light may appear when the Electronic Stability Control (ESC) Indicator Light comes on to indicate that the ESC is not working properly (This does not indicate malfunction of the EPB).

## Motor Driven Power Steering (MDPS) warning light

### This warning light appears:

- Once you set the ignition switch or ENGINE START/STOP button to the ON position.
  - This indicator light comes on after the ignition key is turned to the ON position and then goes out after approximately 3 seconds.
- When there is a malfunction with the MDPS.  
In this case, have the vehicle inspected by a professional workshop. Kia recommends to visit an authorised Kia dealer/service partner.

## Charging System Warning Light



### This warning light appears:

- Once you set the ignition switch or ENGINE START/STOP button to the ON position.
- When there is a malfunction with either the alternator or electrical charging system.

### If there is a malfunction with either the alternator or electrical charging system:

1. Drive carefully to the nearest safe location and stop your vehicle.
2. Turn the engine off and check the alternator drive belt for looseness or breakage.

In this case, have the vehicle inspected by a professional workshop. Kia recommends to visit an authorised Kia dealer/service partner.

## Malfunction Indicator Lamp (MIL)



### This warning light appears:

- When you set the ignition switch or the ENGINE START/STOP button to the ON position.
  - The malfunction indicator light appears for about 3 seconds and then goes off.
- Whenever there is a malfunction with either the emission control system or the engine or the vehicle powertrain. If this occurs, have the vehicle inspected by a professional workshop. Kia recommends to visit an authorised Kia dealer/service partner.

### CAUTION

#### Malfunction Indicator Lamp (MIL)

Driving with the Malfunction Indicator Lamp (MIL) on may cause damage to the emission control systems which could effect drivability and/or fuel economy.

### CAUTION

#### Diesel Engine

If the Malfunction Indicator Lamp (MIL) blinks, some error related to the injection quantity adjustment occurs which could result in loss of engine power, combustion noise and poor emission.

In this case, have the engine control system inspected by a professional workshop. Kia recommends to visit an authorised Kia dealer/service partner.

## Engine oil pressure warning light



### This warning light appears:

- Once you set the ignition switch or ENGINE START/STOP button to the ON position.
  - It remains on until the engine is started.
- When the engine oil pressure is low.
- Drive carefully to the nearest safe location and stop your vehicle.
- Turn the engine off and check the engine oil level (For more details, refer to "Engine oil and filter (for petrol)" on page 8-19). If the level is low, add oil as required.
- If the warning light remains on after adding oil or if oil is not available, have the vehicle inspected by a professional workshop as soon as possible. Kia recommends to visit an authorised Kia dealer/service partner. Continued driving with the warning light on may cause engine failure.

### \* NOTICE

When engine oil pressure decreases due to insufficient engine oil, etc., the Engine Oil Pressure warning light will appear.

For Smartstream G1.5 T-GDi engine, the enhanced engine protection system which limits engine power will be activated. If the engine oil pressure is restored, the Engine Oil Pressure warning light and the enhanced engine protection system will turn off.

## Fuel Filter Warning Light (Diesel Engine)



### This warning light appears:

- Once you set the ignition switch or ENGINE START/STOP button to the ON position.
    - It appears for approximately 3 seconds and then goes off.
  - When water has accumulated inside the fuel filter. In this case, remove the water from the fuel filter.
- \* For more details, refer to "Fuel Filter (for diesel)" on page 8-31.

### ⚠ CAUTION

#### Fuel Filter Warning Light

- When the Fuel Filter Warning Light appears, engine power (vehicle speed & idle speed) may decrease.
- If you keep driving with the warning light on, engine parts (injector, common rail, high pressure fuel pump) may be damaged. If this occurs, have the vehicle inspected by a professional workshop as soon as possible. Kia recommends to visit an authorised Kia dealer/service partner.

## Low Fuel Level Warning Light

### This warning light appears:

When the fuel tank is nearly empty.

### If the fuel tank is nearly empty:

Add fuel as soon as possible.

**⚠ CAUTION****Low Fuel Level**

Driving with the Low Fuel Level warning light on or with the fuel level below "E" can cause the engine to misfire and damage the catalytic converter. (if equipped)

**Low Tyre Pressure Warning Light**

 (if equipped)

**This warning light appears:**

- Once you set the ignition switch or ENGINE START/STOP button to the ON position.
  - It appears for approximately 3 seconds and then goes off.
- When one or more of your tyres are significantly under inflated. (The location of the underinflated tyres are displayed on the LCD display).

\* For more details, refer to "Tyre Pressure Monitoring System (TPMS)" on page 7-8.

**This warning light remains on after blinking for approximately 60 seconds or repeats blinking on and off at the intervals of approximately 3 seconds:**

- When there is a malfunction with the TPMS.
 

In this case, have the vehicle inspected by a professional workshop. Kia recommends to visit an authorised Kia dealer/service partner.
- \* For more details, refer to "Tyre Pressure Monitoring System (TPMS)" on page 7-8.

**⚠ WARNING****Low tyre pressure**

- Significantly low tyre pressure makes the vehicle unstable and can contribute to loss of vehicle control and increased braking distances.
- Continued driving on low pressure tyres will cause the tyres to overheat and fail.

**⚠ WARNING****Safe Stopping**

- The TPMS cannot alert you to severe and sudden tyre damage caused by external factors.
- If you notice any vehicle instability, immediately take your foot off the accelerator pedal, apply the brakes gradually with light force, and slowly move to a safe position off the road.

4

**Master warning light ****This indicator light appears:**

- This warning light informs the driver the following situations
  - LED headlamp malfunction (if equipped)
  - Lamp malfunction

To identify the details of the warning look at the LCD display.

If the warning situation is solved, the master warning light will turn off.

### Exhaust system (DPF or LNT) warning light (for diesel engine) (if equipped)

#### This warning light appears:

- When there is a malfunction with Diesel Particulate Filter (DPF) or Lean NOx Trap (LNT) system.
- When this warning light appears, it may turn off after driving the vehicle:
  - at more than 60 km/h (37 mph), or
  - at more than 2nd gear with 1,500 ~ 2,500 engine rpm for a certain time (for about 25 minutes).

If this warning light blinks in spite of the procedure (at this time the LCD warning message will be displayed), have the DPF system checked by a professional workshop. Kia recommends to visit an authorised Kia dealer/service partner.

- When the exhaust gas captures exhaust gases over certain amount or the LNT performance is degraded.
  - In this case, the warning light appears and the warning alarm sounds whilst displaying the warning message "Self Regeneration" on the LCD display. For more details, refer to "Operating Self Regeneration Mode" on page 8-85.

#### CAUTION

#### Diesel Engine with DPF (if equipped)

If you continue to drive with the DPF warning light blinking for a long time, the DPF system can be damaged and fuel consumption can worsen.

### SCR warning light (for diesel engine) (if equipped)

#### This warning light appears:

- When the urea solution tank is nearly empty.

#### If the urea solution tank is nearly empty:

- Refill urea solution as soon as possible.
- \* For more details, refer to "Selective Catalytic Reduction (if equipped)" on page 8-86.

### Exhaust system (PPF) warning light (for petrol engine) (if equipped)

#### This warning light appears:

- When there is a malfunction with Petrol Particulate Filter (PPF) system.
- When this warning light appears, it may turn off after driving the vehicle:
  - The vehicle should be driven for more than 30 minutes at a speed of 80 km/h (50 mph) and faster.
  - Ensure the following conditions are all met: safe road conditions, transmission 3rd gear or above, and engine speed of 1,500 - 4,000 rpm.

If this warning light blinks in spite of the procedure (at this time the LCD warning message will be displayed), have the PPF system checked by a professional workshop. Kia recommends to visit an authorised Kia dealer/service partner.

**CAUTION****Petrol Engine with PPF (if equipped)**

If you continue to drive with the PPF warning light blinking for a long time, the PPF system can be damaged and fuel consumption can worsen.

**LED headlamp warning light** **This warning light appears:**

- Once you set the ENGINE START/STOP button to the ON position.
  - It appears for approximately 3 seconds and then goes off.
- When there is a malfunction with the LED headlamp.

In this case, have the vehicle inspected by a professional workshop. Kia recommends to visit an authorised Kia dealer/service partner.

**This warning light blinks:**

- When there is a malfunction with a LED headlamp related part.

In this case, have the vehicle inspected by a professional workshop. Kia recommends to visit an authorised Kia dealer/service partner.

**Forward Safety warning light** **This warning light appears:**

- Yellow:
  - When you set the ignition switch or ENGINE START/STOP button to the ON position, it appears for approximately 3 seconds and then goes off.

- When Forward Collision-Avoidance Assist is Off/disable/malfunction. In this case, have the vehicle inspected by a professional workshop. Kia recommends to visit an authorised Kia dealer/service partner.

- Red:
  - When Forward Collision-Avoidance Assist is operating, it appears blinking.

\* For more details, refer to "Forward Collision-Avoidance Assist (FCA) (Sensor fusion) (if equipped)" on page 6-4.

**Indicator lights****Electronic stability control (ESC) indicator light** **This indicator light appears:**

- Once you set the ignition switch or ENGINE START/STOP button to the ON position.
  - It appears for approximately 3 seconds and then goes off.
- When there is a malfunction with the ESC system.

In this case, have the vehicle inspected by a professional workshop. Kia recommends to visit an authorised Kia dealer/service partner.

**This indicator light blinks:**

Whilst the ESC is operating.

- \* For more details, refer to "Electronic Stability Control (ESC) system (if equipped)" on page 5-50.

## Electronic stability control (ESC) OFF indicator light (if equipped)

### This indicator light appears:

- Once you set the ignition switch or ENGINE START/STOP button to the ON position.
    - It appears for approximately 3 seconds and then goes off.
  - When you deactivate the ESC system by pressing the ESC OFF button.
- \* For more details, refer to "Electronic Stability Control (ESC) system (if equipped)" on page 5-50.

## Auto stop indicator (if equipped)

### This indicator light appears:

- When the engine enters the Idle Stop mode of the ISG (Idle Stop and Go) system.
  - When the automatic starting occurs, the auto stop indicator on the cluster will blink for 5 seconds.
- \* For more details, refer to "Idle Stop and Go (ISG) system (if equipped)" on page 5-56.

### \* NOTICE

When the engine automatically starts by the ISG system, some warning lights (ABS, ESC, ESC OFF, MDPS or Parking brake warning light) may turn on for a few seconds. This happens because of the low battery voltage. It does not mean the system is malfunctioning.

## Immobiliser Indicator Light (Without Smart Key) (if equipped)

### This indicator light appears:

- When the vehicle detects the immobiliser in your key properly whilst the ignition switch is ON.
  - At this time, you can start the engine.
  - The indicator light goes off after starting the engine.

### This indicator light blinks:

- When there is a malfunction with the immobiliser system.  
In this case, have the vehicle inspected by a professional workshop. Kia recommends to visit an authorised Kia dealer/service partner.

## Immobiliser Indicator Light (With Smart Key) (if equipped)

### This indicator light appears for up to 30 seconds:

- When the vehicle detects the smart key in the vehicle properly whilst the ENGINE START/STOP button is ACC or ON.
  - At this time, you can start the engine.
  - The indicator light goes off after starting the engine.

### This indicator light blinks for a few seconds:

- When the smart key is not in the vehicle.
  - At this time, you can not start the engine.

**This indicator light appears for 2 seconds and goes off:**

- When the vehicle can not detect the smart key which is in the vehicle whilst the ENGINE START/STOP button is ON.  
In this case, have the vehicle inspected by a professional workshop. Kia recommends to visit an authorised Kia dealer/service partner.

**This indicator light blinks:**

- When the battery of the smart key is weak.
  - At this time, you can not start the engine. However, you can start the engine if you press the ENGINE START/STOP button with the smart key. (For more details, refer to "Smart key (if equipped)" on page 4-8).
- When there is a malfunction with the immobiliser system.  
In this case, have the vehicle inspected by a professional workshop. Kia recommends to visit an authorised Kia dealer/service partner.

**Turn signal indicator light** 

**This indicator light blinks:**

- When you turn the turn signal light on. If any of the following occurs, there may be a malfunction with the turn signal system. In this case, have the vehicle inspected by a professional workshop. Kia recommends to visit an authorised Kia dealer/service partner.
- The indicator light does not blink but appears.
- The indicator light blinks more rapidly.

- The indicator light does not appear at all.

**Low beam indicator light**  (if equipped)

**This indicator light appears:**

- When the headlights are on.

**High beam indicator light** 

**This indicator light appears:**

- When the headlights are on and in the high beam position.
- When the turn signal lever is pulled into the Flash-to-Pass position.

**High Beam Assist indicator light**  (if equipped)

**This indicator light appears:**

- When the high beam is on with the light switch in the AUTO light position.
- If your vehicle detects oncoming or preceding vehicles, High Beam Assist will switch the high beam to low beam automatically.

\* For more details, refer to "High Beam Assist (HBA) (if equipped)" on page 4-81.

**Lane Safety indicator light**  (if equipped)

**This indicator light appears:**

- Green: When Lane Keeping Assist operating conditions are satisfied.
- Gray: When Lane Keeping Assist operating conditions are not satisfied.



4



- Yellow: Whenever there is a malfunction with Lane Keeping Assist.

In this case, have the vehicle inspected by a professional workshop. Kia recommends to visit an authorised Kia dealer/service partner.

\* For more details, refer to "Lane Keeping Assist (LKA) (if equipped)" on page 6-17.

### Driver Attention Warning light

 (if equipped)

#### This indicator light illuminates:

- When the ignition switch is in the ON position. It illuminates for about 3 seconds and then goes off.
- Yellow: When Driver Attention Warning is disabled or a malfunction is detected. If the yellow indicator light remains on after the front view camera has been uncovered or unblocked, we recommend that your vehicle be inspected by an authorised Kia dealer/service partner.

#### This indicator light blinks:

- Yellow: Driver Attention Warning recommends to take a break.
- \* For more details, refer to "Driver Attention Warning (DAW) (if equipped)" on page 6-40.

### Light ON indicator light

#### This indicator light appears:

- When the tail lights or headlights are on.

### Front fog indicator light (if equipped)

#### This indicator light appears:

- When the front fog lights are on.

### Rear fog indicator light (if equipped)

#### This indicator light appears:

- When the rear fog lights are on.

### Glow Indicator Light (for diesel engine)

#### This indicator light appears:

- When the engine is being preheated with the ignition switch or ENGINE START/STOP button in the ON position.
  - The engine can be started after the glow indicator light goes off.
  - The illumination time varies with the engine coolant temperature, air temperature, and battery condition.

If the indicator light remains on or blinks after the engine has warmed up or whilst driving, there may a malfunction with the engine preheating system.

In this case, have the vehicle inspected by a professional workshop. Kia recommends to visit an authorised Kia dealer/service partner.

#### \* NOTICE

#### Engine Preheating

If the engine does not start within 10 seconds after the preheating is completed, set the ignition switch or ENGINE START/STOP button to the LOCK or OFF

position for 10 seconds and then to the ON position in order to preheat the engine again.

### Cruise indicator light CRUISE (if equipped)

**This indicator light appears:**

- When Cruise Control is enabled.
- \* For more details, refer to "Cruise Control (CC) (if equipped)" on page 6-48.

### AUTO HOLD indicator light (if equipped)

**This indicator light appears:**

- White: When you activate the auto hold system by pressing the AUTO HOLD button.
- Green: When you stop the vehicle completely by depressing the brake pedal with the auto hold system activated.
- Yellow: When there is a malfunction with the auto hold system.  
In this case, have your vehicle inspected by a professional workshop. Kia recommends to visit an authorised Kia dealer/service partner.

\* For more details, refer to "AUTO HOLD (if equipped)" on page 5-46.

### Infotainment system vehicle settings (if equipped)



OSP21043465

Vehicle Settings in the infotainment system provide user options for the settings including door lock/unlock, convenience features, and driver assistance.

#### WARNING

Do not operate the 'Vehicle Settings' whilst driving. This may cause distraction resulting in an accident.

### Setting your vehicle



OSP21083040

[A]: Settings

1. Select 'Settings' on the infotainment system screen.



[A]: Vehicle

2. Select 'Vehicle' and change the settings for features.

### Vehicle Settings menu

1. Driver assistance
2. Head-up display
3. Cluster
4. Climate
5. Seat
6. Door
7. Convenience

#### \* NOTICE

The information provided may differ depending on which features are applicable to your vehicle.

#### \* INFORMATION

The infotainment system may change after software updates. For more information, refer to the manual provided in the infotainment system and the quick reference guide.

## Head-Up Display (HUD) (if equipped)

The head up display is a transparent display which projects a shadow of some information of the instrument cluster and navigation on the HUD screen.

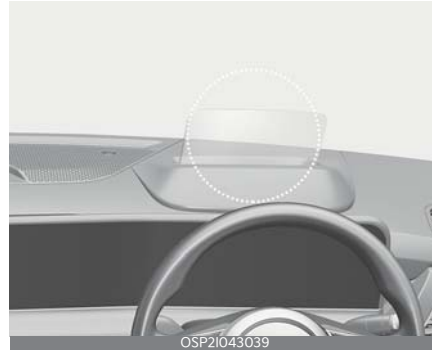

1. Combiner
2. Shutter

The hidden screen will go up when you press the screen operation switch on the right side of the lower part of crash pad and if you press the switch again, the screen will return to its original hidden position.

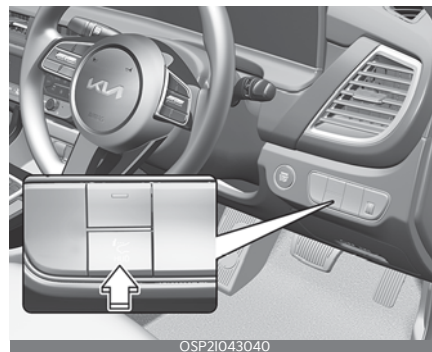

- The head up display image on the HUD screen may be invisible when:
  - Sitting posture is bad.

- Wearing a polarized sunglasses.
  - There is an object on the cover of the head up display.
  - Driving on a wet road.
  - An inadequate lighting is turned on inside the vehicle.
  - Any light comes from the outside.
  - Wearing an inadequate glasses to your eyesight.
- If the head up display image is not shown well, adjust the height, rotation or illumination of the head up display in the cluster.
  - When the head up display needs inspection or repair, Kia recommends to visit an authorised Kia dealer/service partner.

3. Speedometer
4. SCC set speed information (if equipped)
5. SCC vehicle distance information (if equipped)
6. Lane Safety information (if equipped)
7. Blind-Spot Safety information (if equipped)
8. Warning lights (Low fuel)
9. Infotainment system information
10. Lane Following Assist information (if equipped)

**\* NOTICE**

Road Signs and Turn By Turn navigation information are available depending on the region.



**⚠ WARNING**

**Head-Up Display**

- Do not place any accessories on the Head Up Display shutter. It might fall into Head Up Display and can damage to Head Up Display.

**Head Up Display Information**



1. Turn By Turn navigation information (if equipped)
2. Road signs

**Head up Display Setting**

On the LCD display, you can change the head up display settings as follows.

1. Display height
2. Rotation
3. Brightness
4. Content selection

\* For more details, refer to "User settings mode (if equipped)" on page 4-52.

## Lighting

This vehicle is equipped with a variety of lights to illuminate the interior and exterior of the vehicle.

### ⚠ CAUTION

To prevent the battery from being discharged, do not leave the headlight and interior light on for a prolonged time whilst the engine is not running.

### Battery saver function

The purpose of this feature is to prevent the battery from being discharged if the lights are left in the ON position.

The system automatically shuts off the position lamp after the engine is off and the driver's door is opened.

However, the position lamp stay ON even when the driver-side door is opened if the light switch is operated after the engine is turned off.

If necessary, to keep the lights on turn the position lamp OFF and ON again using the headlight switch on the steering column after the engine is turned off.

### Daytime Running Light (DRL) (if equipped)

The Daytime Running Light (DRL) can make it easier for others to see the front of your vehicle during the day.

The DRL can be helpful in many different driving conditions, and it is especially helpful after dawn and before sunset.

The DRL will turn the dedicated lamp OFF when:

- The headlight switch is on.
- The vehicle is off.
- The front fog light is on.
- Engaging the Parking Brake.

## Lighting control

The light switch has a headlight and a position lamp position.



To operate the lights, turn the knob at the end of the control lever to one of the following positions:

1. OFF position
2. Auto light position (if equipped)
3. Position & Tail lamp
4. Headlight position

### Position & Tail lamp



When the light switch is in the position lamp position, the front position lamp and auxiliary lamp (if equipped), tail, license light will turn ON.

**\* NOTICE**  
 Auxiliary lamp will be ON only in position lamp  condition.

**Head light (Low Beam) **



When the light switch is in the head light position, head light (low beam), tail, license light will turn ON.

**\* NOTICE**  
 The ignition switch must be in the ON position to turn on the headlights.

**Auto light (if equipped)**

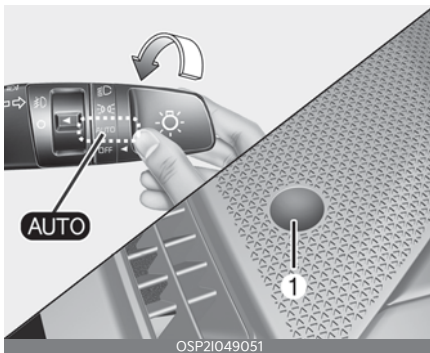

When the light switch is in the AUTO light position, the taillights and headlights will turn ON or OFF automatically depending on the amount of light outside the vehicle.

**▲ CAUTION**

- Never place anything over the sensor (1) located on the instrument panel as this will ensure better auto-light system control.
- Don't clean the sensor using a window cleaner, the cleaner may leave a light film which could interfere with sensor operation.
- If your vehicle has window tint or other types of metallic coating on the front windshield, the Auto light system may not work properly.



4

**Operating high beam **

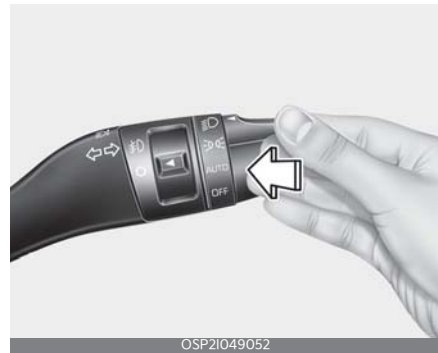

To turn on the high beam headlamp:

- Push the lever away from you. The lever will return to its original position. The high beam indicator will light when the headlight high beams are switched on.

**⚠ WARNING**

Do not use high beam when there are other vehicles. Using high beam could obstruct the other driver's vision.

To flash the headlights:

- Pull the lever towards you.

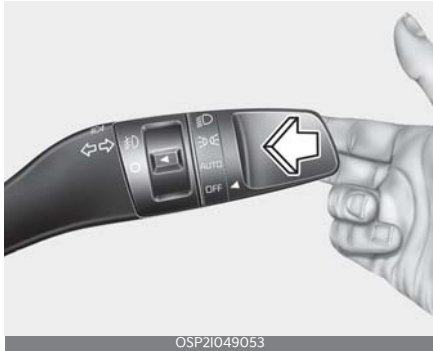

OSP21049053

It will return to the normal (low beam) position when released. The headlight switch does not need to be on to use this flashing feature.

**Operating turn signals and lane change signals**

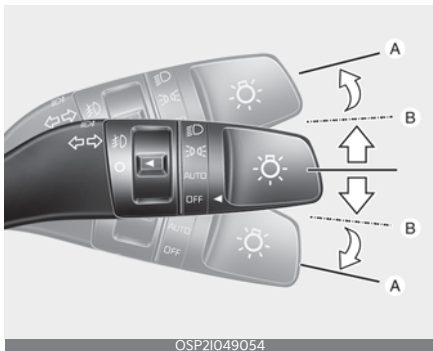

OSP21049054

The ENGINE START/STOP button must be on for the turn signals to function.

To turn on the turn signals:

- Move the lever up or down (A).

The green arrow indicators on the instrument panel indicate which turn signal is operating.

They will self-cancel after a turn is completed. If the indicator continues to flash after a turn, manually return the lever to the OFF position.

To signal a lane change:

- Move the turn signal lever slightly and hold it in position (B).

The lever will return to the OFF position when released.

If an indicator stays on and does not flash or if it flashes abnormally, one of the turn signal bulbs may be burned out and will require replacement.

**One-touch lane change function**

To activate a one-touch lane change function, move the turn signal lever slightly and then release it. The lane change signals will blink 3, 5 or 7 times. You can activate or deactivate the One Touch Turn Signal function or choose the number of blinking (3, 5, or 7) by selecting "User Settings → Lights → One Touch Turn signal".

**\* NOTICE**

If an indicator flash is abnormally quick or slow, a bulb may be burned out or have a poor electrical connection in the circuit.

**Operating front fog light  (if equipped)**

Fog lights are designed to provide improved visibility when visibility is poor due to fog, rain or snow, etc.



The fog lights will turn on when the fog light switch (1) is turned to the on position after the headlight is turned on.

To turn off the fog lights:

- Turn the fog light switch (1) to the ON position.

**⚠ CAUTION**

When in operation, the fog lights consume large amounts of vehicle electrical power. Only use the fog lights when visibility is poor.

**High Beam Assist (HBA) (if equipped)**



High Beam Assist is a function that automatically adjusts the headlamp range

(switches between high beam and low beam) depending on the brightness of detected vehicles and certain road conditions.

**Detecting sensor**

[1]: Front view camera



4

The front view camera is used as a detecting sensor to detect ambient light and brightness whilst driving. Refer to the picture for the detailed location of the detecting sensor.

**\* NOTICE**

- Always keep the front view camera in good condition to maintain optimal performance of High Beam Assist.
- For more details on the precautions of the front view camera, refer to "Forward Collision-Avoidance Assist (FCA) (Sensor fusion) (if equipped)" on page 6-4.



## High Beam Assist setting

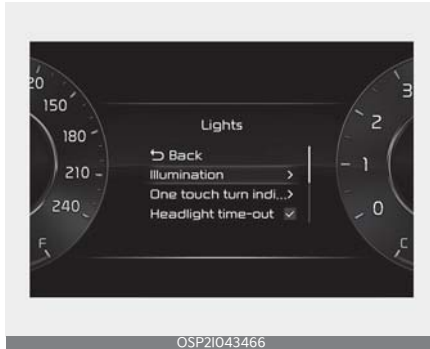



With the ignition switch or ENGINE START/STOP button in the ON position, select 'User settings → Lights → HBA (High Beam Assist)' on the LCD display or 'Settings → Vehicle → Lights → HBA (High Beam Assist)' on the infotainment system.

### **⚠ WARNING**

For your safety, change the Settings after parking the vehicle at a safe location.

## High Beam Assist operation

### Display and control

- After selecting 'HBA (High Beam Assist)' in the Settings menu, High Beam Assist will operate by following the procedure below.
  - Place the headlamp switch in the AUTO position and push the headlamp lever towards the instrument cluster. High Beam Assist  indicator light will appear on the cluster and the function will be enabled.
  - When the function is enabled, high beam will turn on when vehicle speed is above 30 km/h (20 mph). When vehicle speed is below 20 km/h (12 mph), high beam will not turn on.
- The High Beam  indicator light will appear on the cluster when high beam is on.
- When High Beam Assist is operating, if the headlamp lever or switch is used, the function operates as follow:
  - If the headlamp lever is pulled towards you when the high beam is off, the high beam will turn on without High Beam Assist cancelled. When you let go of the headlamp lever, the lever will move to the middle and the high beam will turn off.
  - If the headlamp lever is pulled towards you when the high beam is on by High Beam Assist, low beam will be on and the function will turn off.
  - If the headlamp switch is placed from AUTO to another position (headlamp/position/off), High Beam Assist will turn off and the corresponding lamp will turn on.
- When High Beam Assist is operating, high beam switches to low beam if any of the following conditions occur:
  - When the headlamp of an oncoming vehicle is detected.
  - When the tail lamp of a vehicle in front is detected.
  - When the headlamp or tail lamp of a motorcycle or a bicycle is detected.
  - When the surrounding ambient light is bright enough that high beams are not required.

- When streetlights or other lights are detected.

### \* NOTICE

Images and colours in the instrument cluster may appear different depending on the instrument cluster options or themes.

## High Beam Assist malfunction and limitations

### High Beam Assist malfunction

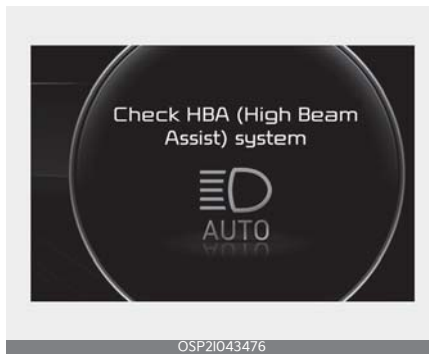

When High Beam Assist is not working properly, the 'Check HBA (High Beam Assist) system' warning message will appear and 「!」 warning light will appear on the cluster. In this case, have the function inspected by a professional workshop. Kia recommends to visit an authorised Kia dealer/service partner.

### Limitations of High Beam Assist

High Beam Assist may not work properly in the following situations:

- Light from a vehicle is not detected because of lamp damage, or because it is hidden from sight, etc.
- Headlamp of a vehicle is covered with dust, snow or water.
- A vehicle's headlamps are off but the fog lamps are on and etc.
- There is a lamp that has a similar shape as a vehicle's lamp.
- Headlamps have been damaged or not repaired properly.
- Headlamps are not aimed properly.
- Driving on a narrow curved road, rough road, uphill or downhill.
- Vehicle in front is partially visible on a crossroad or curved road.
- There is a traffic light, reflecting sign, flashing sign or mirror ahead.
- There is a temporary reflector or flash ahead (construction area).
- The road conditions are bad such as being wet, iced or covered with snow.
- A vehicle suddenly appears from a curve.
- The vehicle is tilted from a flat tyre or is being towed.
- Light from a vehicle is not detected because of exhaust fume, smoke, fog, snow, etc.

### \* NOTICE

For more details on the limitations of the front view camera, refer to "Forward Collision-Avoidance Assist (FCA) (Sensor fusion) (if equipped)" on page 6-4.

### ⚠ WARNING

- At times, High Beam Assist may not work properly. The function is for your convenience only. It is the responsibility of the driver for safe driving practices and always check the road conditions for your safety.
- When High Beam Assist does not operate normally, change the headlamp position manually between high beam and low beam.

- When starting the vehicle or resetting the front camera, the High Beam Assist may not operate for approximately 15 seconds.

Loading condition	Switch position
Driver + Maximum permissible loading	3

## Headlight levelling device



OSP21043056

To adjust the headlight beam level according to the number of the passengers and loading weight in the luggage area, turn the beam levelling switch.

The higher the number of the switch position, the lower the headlight beam level. Always keep the headlight beam at the proper levelling position, or headlights may dazzle other road users.

Listed below are the examples of proper switch settings. For loading conditions other than those listed below, adjust the switch position so that the beam level may be the nearest as the condition obtained according to the list.

Loading condition	Switch position
Driver only	0
Driver + Front passenger	0
Full passengers (including driver)	1
Full passengers (including driver) + Maximum permissible loading	2

## Wipers and washers

The wipers and washers remove foreign substances from the windscreen and rear window, helping to maintain visibility.

Front windscreen wiper/washer

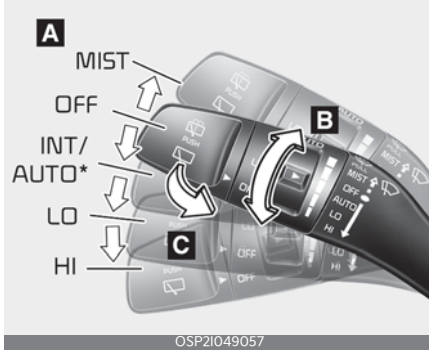

Rear windscreen wiper/washer



### A: Wiper speed control (front)

- MIST - Single wipe
- OFF - Off
- INT - Intermittent wipe
- AUTO\* - Auto control wipe
- LO - Low wiper speed
- HI - High wiper speed

### B: Intermittent control wipe time adjustment

### C: Wash with brief wiper (front)

### D: Rear wiper/washer control \*

- HI - Continuous wipe
- LO - Intermittent wipe
- OFF - Off

### E: Wash with brief wiper (rear)

\*: if equipped

### \* NOTICE

If there is heavy accumulation of snow or ice on the windscreen, defrost the windscreen for about 10 minutes, or until the snow and/or ice is removed before using the windscreen wipers to ensure proper operation. If you do not remove the snow and/or ice before using the wiper and washer, it may damage the wiper and washer system.

### \* INFORMATION

If you operate the wipers while driving on snowy roads, the wipers may stop due to snow buildup on your windshield. This is normal and not a failure because it is one of our safety features to prevent vehicle accidents and wiper damage from overloading the wiper motor. If the wipers stop, remove snow accumulated on the top or bottom of windshield before using them.

## Auto control (if equipped)

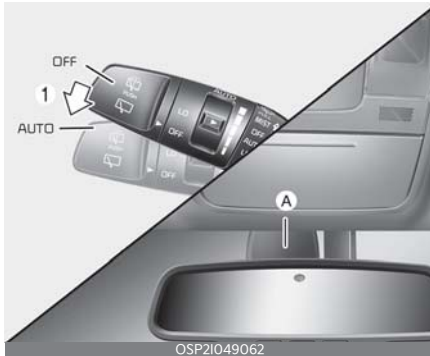

The rain sensor (A) located on the upper end of the windscreen glass senses the amount of rainfall and controls the wiping cycle for the proper interval. The more it rains, the faster the wiper operates. When the rain stops, the wiper stops.

To vary the speed setting, turn the speed control knob (1).

If the wiper switch is set in AUTO mode when the ignition switch is ON, the wiper will operate once to perform a self-check of the system. Set the wiper to OFF position when the wiper is not in use.

### ⚠ CAUTION

When the ignition switch is ON and the windscreen wiper switch is placed in the AUTO mode, use caution in the following situations to avoid any injury to the hands or other parts of the body:

- Do not touch the upper end of the windscreen glass facing the rain sensor.
- Do not wipe the upper end of the windscreen glass with a damp or wet cloth.

- Do not put pressure on the windscreen glass.

### ⚠ CAUTION

- When washing the vehicle, set the wiper switch in the OFF position to stop the auto wiper operation. The wiper may operate and be damaged if the switch is set in the AUTO mode whilst washing the vehicle.
- Do not remove the sensor cover located on the upper end of the passenger side windscreen glass. Damage to system parts could occur and may not be covered by your vehicle warranty.
- When starting the vehicle in winter, set the wiper switch in the OFF position. Otherwise, wipers may operate and ice may damage the windscreen wiper blades. Always remove all snow and ice and defrost the windscreen properly prior to operating the windscreen wipers.
- When tinting the windscreen, be careful of any fluid getting into the sensor located in the top centre of the front windscreen. It may damage the related parts.

## Operating windscreen washers



OSP21049093

1. Move the wiper speed control switch to In OFF position.
2. Pull the lever gently toward you to spray washer fluid on the windscreen and to run the wipers 1-3 cycles. Use this function when the windscreen is dirty. The spray and wiper operation will continue until you release the lever.

If the washer does not work, check the washer fluid level. If the fluid level is not sufficient, you will need to add appropriate non-abrasive windscreen washer fluid to the washer reservoir.

The reservoir filler neck is located in the front of the motor compartment on the passenger side.

### ⚠ CAUTION

To prevent possible damage to the washer pump, do not operate the washer when the fluid reservoir is empty.

### ⚠ WARNING

Do not use the washer in freezing temperatures without first warming the windscreen with the defrosters; the

washer solution could freeze on the windscreen and obscure your vision.

### ⚠ CAUTION

- To prevent possible damage to the wipers or windscreen, do not operate the wipers when the windscreen is dry.
- To prevent damage to the wiper blades, do not use petrol, kerosene, paint thinner, or other solvents on or near them.
- To prevent damage to the wiper arms and other components, do not attempt to move the wipers manually.
- To prevent possible damage to the wipers and washer system, use anti-freezing washer fluids in the winter season or cold weather.

4

## Operating rear window wiper and washer switch

The rear window wiper and washer switch is located at the end of the wiper and washer switch lever.

- Turn the switch to the desired position to operate the rear wiper and washer.

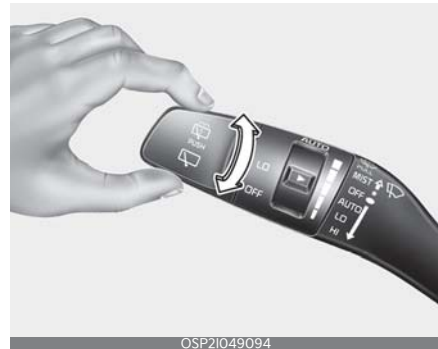

OSP21049094

- HI / 2 - Normal wiper operation
- LO / 1 - Intermittent wiper operation (if equipped)

- OFF / O - Wiper is not in operation
- Push the lever away from you to spray rear washer fluid and to run the rear wipers 1~3 cycles.



OSP21049095

The spray and wiper operation will continue until you release the lever.

## Interior lights

This vehicle is equipped with lights throughout the vehicle to illuminate the interior.

### ⚠ CAUTION

Do not use the interior lights for extended periods when the engine is not running.

It may cause battery discharge.

### ⚠ WARNING

Do not use the interior lights when driving in the dark. Accidents could happen because the view may be obscured by interior lights.

## Automatic turn off function (if equipped)

The interior lights automatically turn off approximately 20 minutes after the ENGINE START/STOP button is turned off, if the lights are in the ON position.

If your vehicle is equipped with the theft alarm system, the interior lights automatically turn off approximately 5 seconds after the system is armed.

## Map lamp

Type A

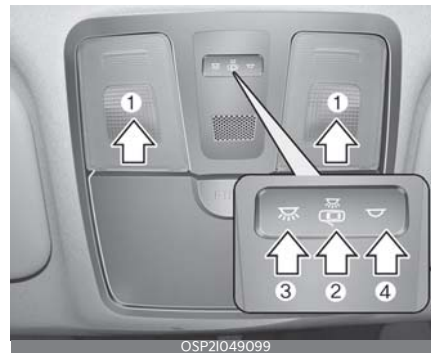

OSP21049099

Type B



- Press the lens (1) to turn ON the map lamp.  
To turn the map lamp OFF press the lens (1) again.
-  (2): DOOR mode
  - The map lamp and room lamp come on when a door is opened. The lamps go out after approximately 30 seconds.
  - The map lamp and room lamp come on for approximately 30 seconds when doors are unlocked with a smart key as long as the doors are not opened.
  - The map lamp and room lamp will stay on for approximately 20 minutes if a door is opened with the ENGINE START/STOP button in the ACC or OFF position.
  - The map lamp and room lamp will stay on continuously if the door is opened with the ENGINE START/STOP button in the ON position.
  - The map lamp and room lamp will go out immediately if the ENGINE START/STOP button is changed to the ON position or all doors are locked.

- To turn off the DOOR mode, press the DOOR button (2) once again (not pressed).
-  (3): Press this switch to turn the front and rear room lamps on and off.

**\* NOTICE**

The DOOR mode and ROOM mode can not be selected at a time.

**Room lamp**



- (1): The light stays on at all times.

**Personal lamp (if equipped)**



Press the switch to turn the room lamp on and off.



4



## Luggage room lamp (if equipped)



The luggage room lamp comes on when the tailgate is opened.

### **CAUTION**

The luggage room lamp comes on as long as the tailgate opens. To prevent unnecessary charging system drain, close the tailgate securely after using the luggage room.

## Welcome system (if equipped)

The welcome system is a function that illuminates the surroundings or the interior when the driver approaches or exits the vehicle.

### Headlight (headlamp) escort function

The headlights (and/or taillights) remain on for approximately 5 minutes after the vehicle is turned off. However, if the driver's door is opened and closed, the headlights are turned off after 15 seconds.

The headlights can be turned off by pressing the lock button on the smart key twice or turning off the light switch from the headlight or Auto light position.

### Interior light

When the interior light switch is in the DOOR position and all doors (and tailgate) are locked and closed, the room lamp will come on for 30 seconds if any of the following occurs:

- With the smart key system
  - When the door unlock button is pressed on the smart key.
  - When the button of the outside door handle is pressed.

At this time, if you press the door lock button, the lamps will turn off immediately.

## Rear Defroster (if equipped)

The vehicle is equipped with a defroster for removing frost or fog from the rear window.

### ⚠ CAUTION

#### Conductors

To prevent damage to the conductors bonded to the inside surface of the rear window, never use sharp instruments or window cleaners containing abrasives to clean the window.

If you want to defrost and defog the front windscreen, refer to "Windscreen defrosting and defogging" on page 4-110.

## Operating rear window defroster

The defroster heats the window to remove frost, fog and thin ice from the rear window, whilst the engine is on.

If there is heavy accumulation of snow on the rear window, brush it off before operating the rear defroster.

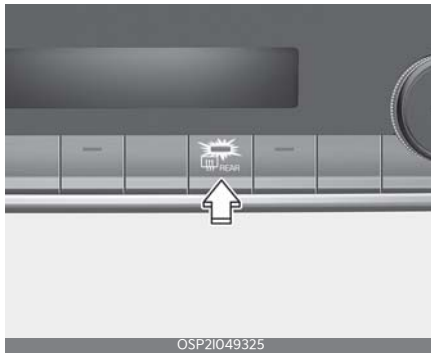

To activate the rear window defroster:

- Press the rear window defroster button located in the heater control panel.

The indicator on the rear window defroster button illuminates when the defroster is ON.

The rear window defroster automatically turns off after approximately 20 minutes or when the ENGINE START/STOP button is turned off.

To turn off the defroster:

- Press the rear window defroster button again.



4

## Climate control system



The climate control system uses cooling and heating to help maintain a pleasant environment inside the vehicle.

### System operation

#### Ventilation

1. Set the mode to the  position.
2. Set the air intake control to the outside (fresh) air position.
3. Set the temperature control to the desired position.
4. Set the fan speed control to the desired speed.

#### Heating

1. Set the mode to the  position.
2. Set the air intake control to the outside (fresh) air position.
3. Set the temperature control to the desired position.
4. Set the fan speed control to the desired speed.
5. If dehumidified heating is desired, turn the air conditioning system on.
  - If the windscreen fogs up, set the mode to the  or  position.

#### Operation tips

- To keep dust or unpleasant fumes from entering the vehicle through the ventilation system, temporarily set the air intake control to the recirculated air position. Be sure to return the control to the fresh air position when the irritation has passed to keep fresh air in the vehicle. This will help keep the driver alert and comfortable.

- Air for the heating/cooling system is drawn in through the grilles just at the base of the windscreen. Care should be taken that these are not blocked by leaves, snow, ice or other obstructions.
- To prevent fog from forming on the inside of the windscreen:
  - Set the air intake control to the fresh air position and the fan speed to the desired position.
  - Turn on the air conditioning system, and adjust the temperature control to desired temperature.

#### Air conditioning (A/C)

All Kia air conditioning systems are filled with R-134a refrigerant.

1. Start the vehicle. Press the A/C button.
2. Set the mode to the  position.
3. Set the air intake control to the outside-air or recirculated air position.
4. Adjust the fan speed control and temperature control to maintain maximum comfort.

#### CAUTION

##### Excessive Air conditioning Use

When using the air conditioning system, monitor the temperature gauge closely whilst driving up hills or in heavy traffic when outside temperatures are high. Air conditioning system operation may cause vehicle overheating. Continue to use the blower fan but turn the air conditioning system off if the temperature gauge indicates vehicle overheating.

**⚠ CAUTION**

The air conditioning system should only be used with the windows and sunroof closed to prevent condensation inside the vehicle that may cause damage to electrical components.

**Air conditioning system operation tips**

- If the vehicle has been parked in direct sunlight during hot weather, open the windows for a short time to let the hot air inside the vehicle escape.
- To help reduce moisture inside of the windows on rainy or humid days, decrease the humidity inside the vehicle by operating the air conditioning system.
- During air conditioning system operation, you may occasionally notice a slight change in vehicle speed as the air conditioning compressor cycles. This is a normal characteristic of system operation.
- To ensure maximum system performance, the air conditioning system should be ran for a few minutes each month.
- When using the air conditioning system, you may notice clear water dripping (or even puddling) on the ground under the passenger side of the vehicle. This is a normal characteristic of system operation.
- Operating the air conditioning system in the recirculated air position provides maximum cooling; however, continual operation in this mode may cause the air inside the vehicle to become stale.

- During cooling operation, you may occasionally notice a misty air flow because of rapid cooling and humid air intake. This is a normal characteristic of system operation.

**Climate control air filter**

The climate control air filter installed behind the glove box filters the dust or other pollutants that come into the vehicle from the outside through the heating and air conditioning system.

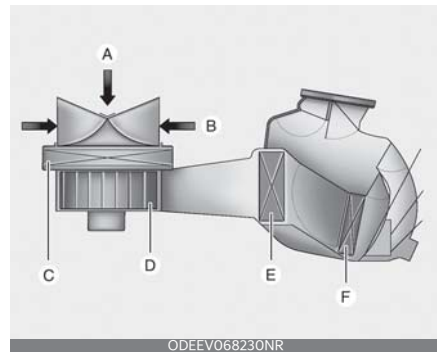

- A: Outside air  
 B: Recirculated air  
 C: Climate control air filter  
 D: Blower  
 E: Evaporator core  
 F: Heater core

If dust or other pollutants accumulate in the filter over a period of time, the air flow from the air vents may decrease. This leads to moisture accumulating on the inside of the windscreen even when the outside (fresh) air position is selected. If this happens, have the climate control air filter replaced by a professional workshop. Kia recommends to visit an authorised Kia dealer/service partner.

### \* NOTICE

- Replace the filter according to the Maintenance Schedule. If the vehicle is being driven in severe conditions such as dusty or rough roads, more frequent air conditioner filter inspections and changes are required.
- When the air flow rate suddenly decreases, have the system checked by a professional workshop. Kia recommends to visit an authorised Kia dealer/service partner.

### Checking the amount of air conditioner refrigerant and compressor lubricant

When the amount of refrigerant is low, the performance of the air conditioning is reduced. Overfilling also has a negative impact on the air conditioning system.

Therefore, if abnormal operation is found, have the system inspected by a professional workshop. Kia recommends to visit an authorised Kia dealer/service partner.

### ⚠ WARNING

The oil and refrigerant in your vehicle's air conditioning system is under very high pressure. If proper service procedures are not followed an explosion may result. To reduce the risk of serious injury or death, the air conditioning system in your vehicle should only be serviced by trained and certified Kia technicians.

### ⚠ CAUTION

It is important that the correct type and amount of oil and refrigerant is used, otherwise, damage to the vehicle may

occur. To prevent damage, the air conditioning system in your vehicle should only be serviced by trained and certified Kia technicians.

### ⚠ WARNING

#### Vehicles equipped with R-134a\*



Because the refrigerant is at very high pressure, the air conditioning system should only be serviced by trained and certified technicians. It is important that the correct type and amount of oil and refrigerant is used.

Otherwise, it may cause damage to the vehicle and personal injury.

### Air conditioning refrigerant label

Example



OSP2I062031

\* The actual air conditioning refrigerant label in the vehicle may differ from the illustration.

Each symbol and specification on the air conditioning refrigerant label is represented below:

1. Classification of refrigerant
2. Amount of refrigerant
3. Classification of Compressor lubricant
4. Caution

5. Service manual

Refer to "Refrigerant label" on page 9-15 for more detail on the location of air conditioning refrigerant label.

**Sunroof inside air recirculation (if equipped)**

The outside (fresh) air position is automatically selected, when the sunroof is opened. When you select the recirculated air position, the system maintains the recirculated air position for 3 minutes and then automatically converts to the outside (fresh) air position. When the sunroof is closed, the air intake position will return to the original position that was selected.



4

## Manual climate control system (if equipped)

The manual climate control system uses cooling and heating to help maintain a pleasant environment inside the vehicle.





1. Fan speed control knob
2. Air intake control button
3. Mode selection knob
4. Temp control knob
5. Air conditioning (A/C) button
6. Rear window defroster (if equipped)

### **⚠ CAUTION**

Operating the blower when the ignition switch is in the ON position could cause the battery to discharge. Operate the blower when the engine is running.

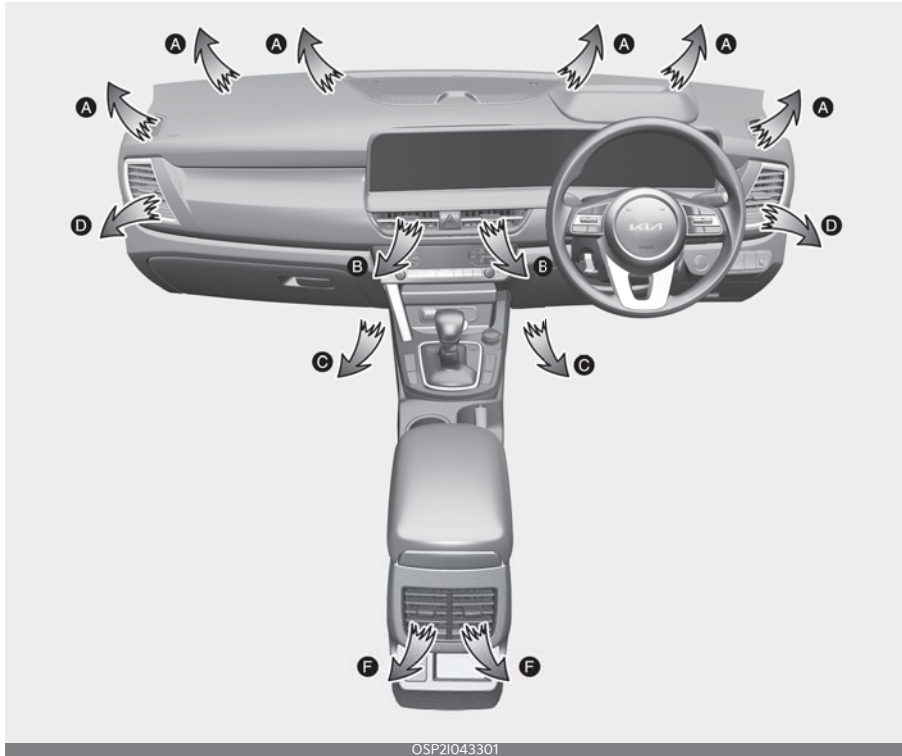
## Heating and air conditioning



1. Start the engine.
2. Set the mode to the desired position.  
For improving the effectiveness of heating and cooling;
  - Heating: 
  - Cooling: 
3. Set the temperature control to the desired position.
4. Set the air intake control to the outside (fresh) air position.
5. Set the fan speed control to the desired speed.  
If air conditioning is desired, turn the air conditioning system on.



## Mode selection

The mode selection buttons control the direction of the air flow through the ventilation system.



Air can be directed to the floor, dashboard outlets, or windscreen. Five symbols are used to represent Face, Bi-Level, Floor, Floor-Defrost and Defrost air position.

### Face-Level (B, D, F)

Air flow is directed toward the upper body and face. Additionally, each outlet can be controlled to direct the air discharged from the outlet.

### Bi-Level (B, C, D, F)

Air flow is directed towards the face and the floor.

### Floor-Level (A, C, D, F)

Most of the air flow is directed to the floor, with a small amount of the air being directed to the windscreen, side window defrosters and side air vents.

### Floor/Defrost-Level (A, C, D)

Most of the air flow is directed to the floor and the windscreen with a small amount directed to the side window defrosters and side air vents.

### Defrost-Level (A, D)

Most of the air flow is directed to the windscreen with a small amount of air directed to the side window defrosters and side air vents.

## Instrument panel vents

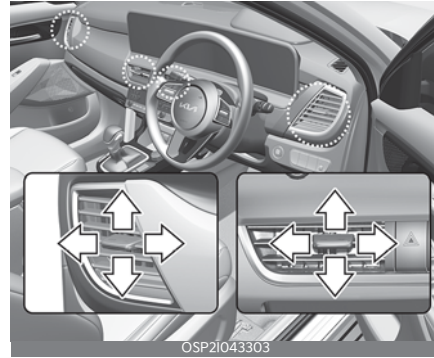

You can adjust the direction of air delivered from these vents using the vent control lever as shown.

## Temperature control

The temperature control knob allows you to control the temperature of the air flowing from the ventilation system.



To change the air temperature in the passenger compartment, turn the knob

to the right for warm and hot air or to the left for cooler air.

### Controlling air intake

The air intake control is used to select the outside (fresh) air position or recirculated air position.

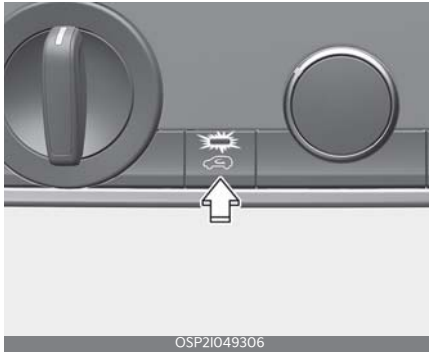

To change the air intake control position.

- Push the desired control button

### Recirculated air position



The indicator light on the button illuminates when the recirculated air position is selected. With the recirculated

air position selected, air from the passenger compartment will be drawn through the heating system and heated or cooled according to the function selected.

### Outside (fresh) air position



The indicator light on the button will turn off when the outside (fresh) air position is selected. With the outside

(fresh) air position selected, air enters the vehicle from outside and is heated or cooled according to the function selected.

### \* NOTICE

Prolonged operation of the heater in the recirculated air position (without air conditioning selected) may cause fogging of the windscreen and side windows and make the air in the passenger compartment stale.

In addition, prolonged use of the air conditioning with the recirculated air position selected will result in excessively dry air in the passenger compartment.

### ⚠ WARNING

- Continued use of the climate control system in the recirculated air position may allow humidity to increase inside the vehicle which may fog the glass and obscure visibility.
- Do not sleep in a vehicle with the air conditioning or heating system on. It may cause serious harm or death due to a drop in the oxygen level and/or body temperature.
- Continued use of the climate control system in the recirculated air position can cause drowsiness or sleepiness, and loss of vehicle control. Set the air intake control to the outside (fresh) air position as much as possible whilst driving.

### Controlling fan speed

The fan speed control knob allows you to control the fan speed of the air flowing from the ventilation system.

The ENGINE START/STOP button must be in the ON position for fan operation.

To change the fan speed:

- Turn the knob to the right for higher speed or left for lower speed.



- Setting the fan speed control knob to the "0" position turns off the fan.

### Turning off the blowers

To turn off the blowers:

- Turn the fan speed control knob to the "0" position.



### Air conditioning (A/C)

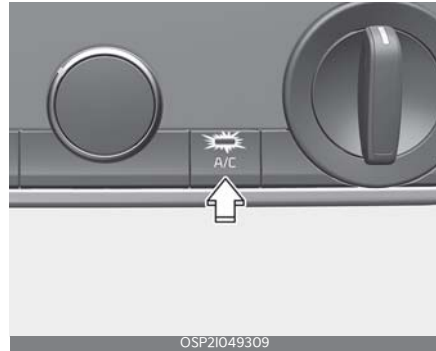

- Press the A/C button to turn the air conditioning system on (indicator light will illuminate).
- Press the button again to turn the air conditioning system off.

### Automatic climate control system (if equipped)

The automatic climate control system uses cooling and heating to help maintain a pleasant environment inside the vehicle.

Type A

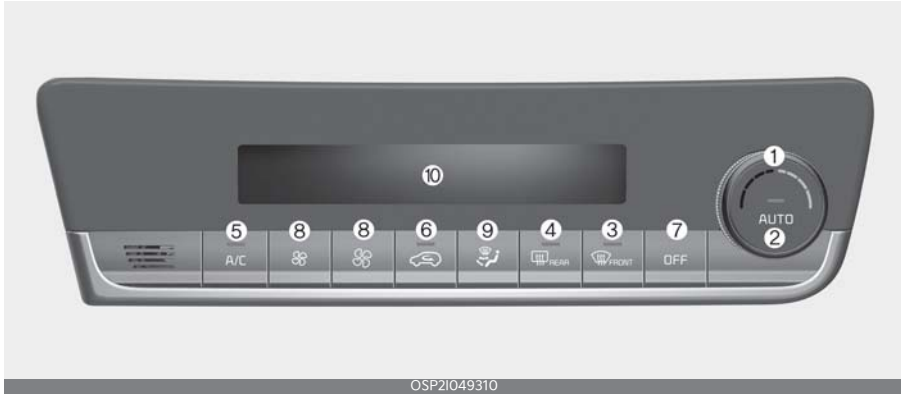

OSP21049310

Type B



OSP21043334

- |                                      |                            |
|--------------------------------------|----------------------------|
| 1. Temperature control button        | 10.Climate control display |
| 2. AUTO (automatic control) button   | 11.SYNC button             |
| 3. Front windscreen defroster button |                            |
| 4. Rear window defroster button      |                            |
| 5. Air conditioning (A/C) button     |                            |
| 6. Air intake control button         |                            |
| 7. OFF button                        |                            |
| 8. Fan speed control button          |                            |
| 9. Mode selection button             |                            |

**\* NOTICE**

Operating the blower when the ignition switch is in the ON position could cause the battery to discharge. Operate the blower when the engine is running.

**Heating and air conditioning automatically**

1. Press the AUTO button.

The modes, fan speeds, air intake and air-conditioning will be controlled automatically by setting the temperature.

Type A



OSP21049311

Type B

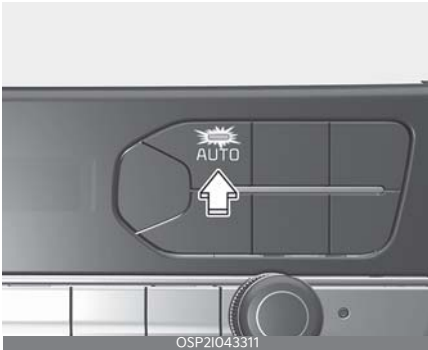

OSP21043311

2. Turn the temperature control switch (Type A) or press the button (Type B) to control the desired temperature.

Type A



OSP21049312

Type B

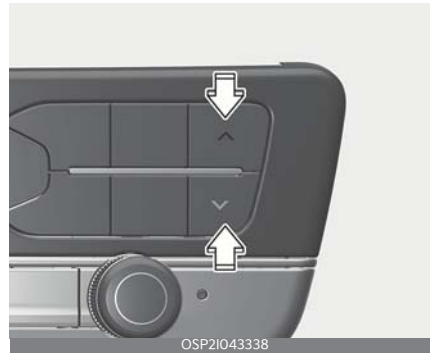

OSP21043338

**\* NOTICE**

- To turn the automatic operation off, select any button or switch of the following:
  - Mode selection button
  - Air conditioning button
  - Front windscreen defroster button (Press the button one more time to deselect the front windscreen defroster function. The AUTO sign will illuminate on the information display once again.)

## Features of your vehicle

- Fan speed control knob

The selected function will be controlled manually whilst other functions operate automatically.

- For your convenience and to improve the effectiveness of the climate control, use the AUTO button and set the temperature to 22 °C (72 °F).

### \* NOTICE

Never place anything over the sensor located on the instrument panel to ensure better control of the heating and cooling system.

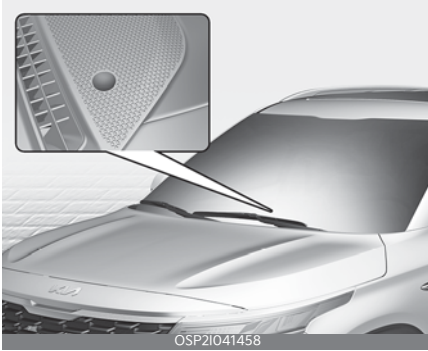

## Automatic climate control system

4

## Heating and air conditioning manually

The heating and cooling system can be controlled manually by pressing buttons other than the AUTO button.

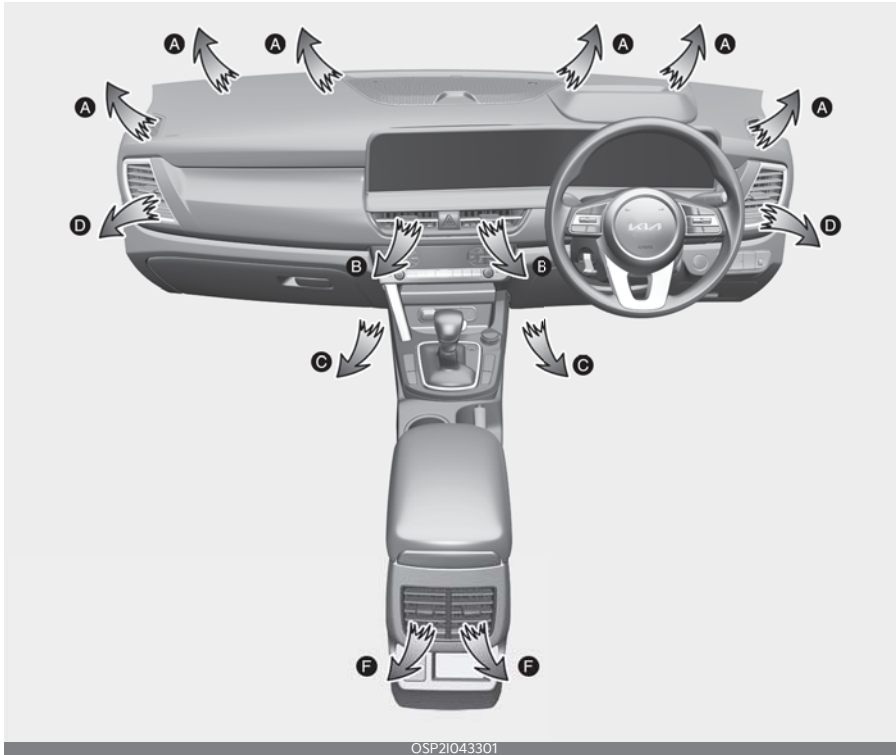

In this case, the system works sequentially according to the order of buttons selected.

1. Start the vehicle.
2. Set the mode to the desired position.  
For improving the effectiveness of heating and cooling;
  - Heating:
  - Cooling:
3. Set the temperature control to the desired position.
4. Set the air intake control to the outside (fresh) air position.
5. Set the fan speed control to the desired speed.

If air conditioning is desired, turn the air conditioning system on.

Press the AUTO button in order to convert to fully automatic control of the system.

### Mode selection

The mode selection button controls the direction of the air flow through the ventilation system.

Type A

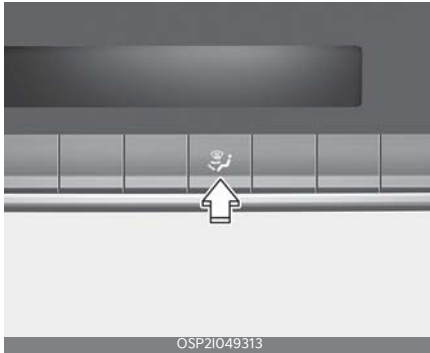

Type B

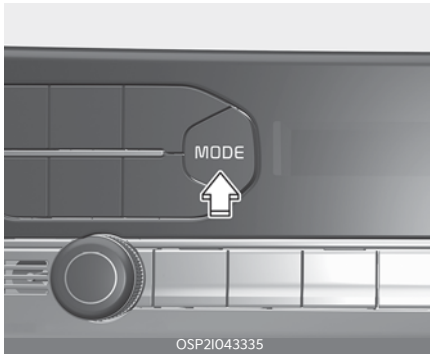

The air flow outlet ports are switched in the following sequence:



#### Face-Level (B, D, F)

Air flow is directed toward the upper body and face. Additionally, each outlet can be controlled to direct the air discharged from the outlet.

#### Bi-Level (B, C, D, F)

Air flow is directed towards the face and the floor.

#### Floor-Level (A, C, D, F)

Most of the air flow is directed to the floor, with a small amount of the air being directed to the windscreen, side window defrosters and side air vents.

#### Floor/Defrost-Level (A, C, D, F)

Most of the air flow is directed to the floor and the windscreen with a small amount directed to the side window defrosters and side air vents.

#### Defrost-Level (A, D)

Type A

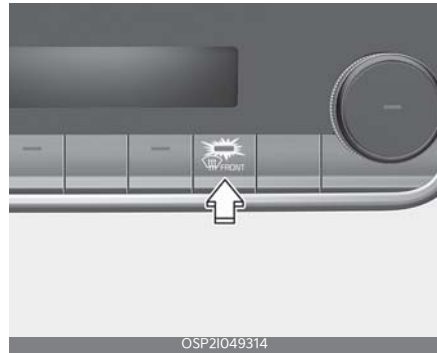



Type B



Most of the air flow is directed to the windscreen with a small amount of air directed to the side window defrosters and side air vents.

**Instrument panel vents**

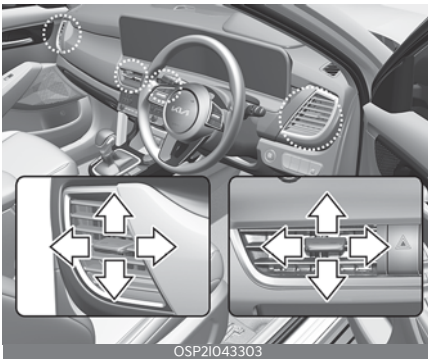

You can adjust the direction of air delivered from these vents using the vent control lever as shown.

**Temperature control**

Type A



Type B

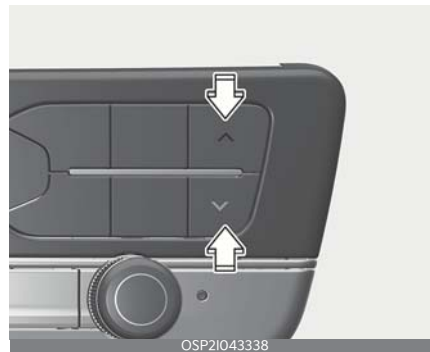

The temperature will increase to the maximum (HI) by rotating the knob clockwise direction (Type A) or press the button (Type B). The temperature will decrease to the minimum (Lo) by rotating the knob anti clock wise direction (Type A) or press the lower button. When rotating the knob or press the button, the temperature will increase or decrease by 0.5 °C. When set to the lowest temperature setting, the air conditioning will operate continuously.

### Changing temperature scale

You can switch the temperature mode from Centigrade to Fahrenheit as follows:

- Whilst pressing the OFF button, press the AUTO button for 3 seconds or more.

The display will change from Centigrade to Fahrenheit, or from Fahrenheit to Centigrade. If the battery has been discharged or disconnected, the temperature mode display will reset to Centigrade.

### Adjusting driver and passenger side temperature equally (Type B)



1. Press the "SYNC" button to adjust the driver and passenger side temperature equally.  
The passenger side temperature will be set to the same temperature as the driver side temperature.
2. Move the driver side temperature control switch. The driver and passenger side temperature will be adjusted equally.
3. If you move the passenger's temperature control switch, the SYNC button is off and the passenger side temperature can be operated individually.

### Adjusting the driver and passenger side temperature individually

Press the "SYNC" button again to adjust the driver and passenger side temperature individually. The button indicator will turn off.

### Changing temperature scale

You can switch the temperature mode from Centigrade to Fahrenheit as follows:

- While pressing the OFF button, press the AUTO button for 3 seconds or more.

The display will change from Centigrade to Fahrenheit, or from Fahrenheit to Centigrade. If the battery has been discharged or disconnected, the temperature mode display will reset to Centigrade.

### Controlling air intake

This is used to select the outside (fresh) air position or recirculated air position.

Type A

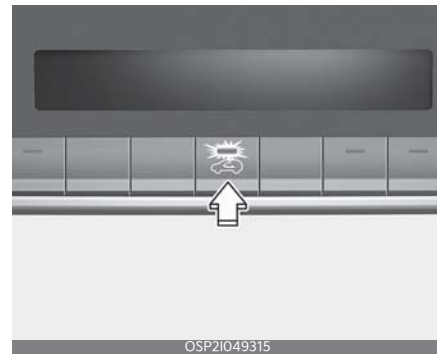

Type B

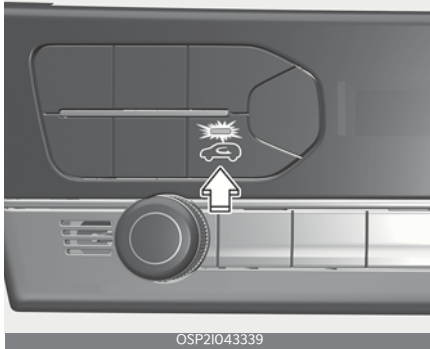

To change the air intake control position:

- Push the desired control button.

### Recirculated air position



With the recirculated air position selected, air from the passenger compartment will be drawn through the heating system and heated or cooled according to the function selected.

### Outside (fresh) air position



With the outside (fresh) air position selected, air enters the vehicle from outside and is heated or cooled according to the function selected.

### \* NOTICE

Prolonged operation of the heater in the recirculated air position (without air conditioning selected) may cause fogging of the windscreen and side windows and the air within the passenger compartment may become stale.

In addition, prolonged use of the air conditioning with the recirculated air position selected will result in excessively dry air in the passenger compartment.

### ⚠ WARNING

- Continued climate control system operation in the recirculated air position may allow humidity to increase inside the vehicle which may fog the glass and obscure visibility.
- Do not sleep in a vehicle with the air conditioning or heating system on. It may cause serious harm or death due to a drop in the oxygen level and/or body temperature.
- Continued climate control system operation in the recirculated air position can cause drowsiness or sleepiness, and loss of vehicle control. Set the air intake control to the outside (fresh) air position as much as possible whilst driving.

### Controlling fan speed

The fan speed can be set to the desired speed by operating the fan speed control button.

To change the fan speed:

- Press button right for higher speed, or press button left for lower speed.

Type A

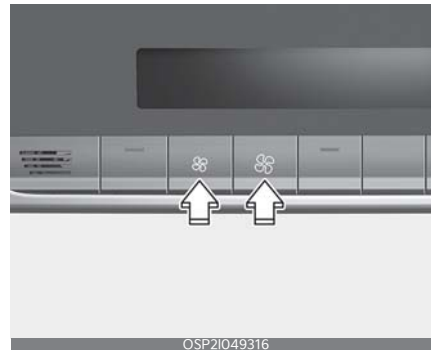

Type B



To turn the fan speed control off:

- Press the OFF button.

### Air conditioning (A/C)

Type A

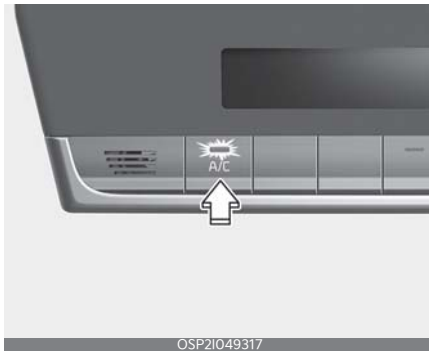

Type B

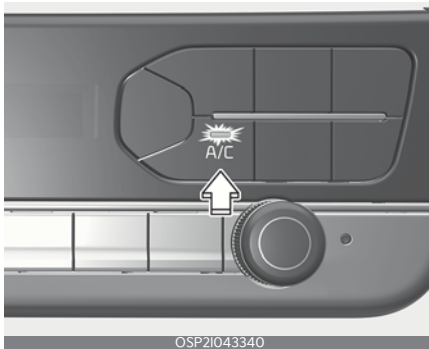

- Press the A/C button to turn the air conditioning system on (indicator light will illuminate).
- Press the button again to turn the air conditioning system off.

### Turning off the front air climate control

Type A

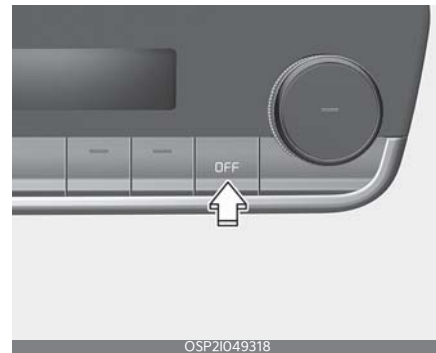

Type B

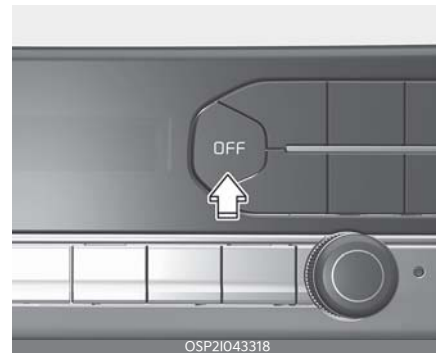

- Press the OFF button to turn off the air climate control system. However, you can still operate the mode and air intake buttons as long as the ENGINE START/STOP button is in the ON position.





4

## Windscreen defrosting and defogging

When the windscreen is covered with frost or moisture, the front view is blurred, you should remove the frost and moisture.

### **⚠ WARNING**

#### Windshield heating

Do not use the  or  position during cooling operation in extremely humid weather. The difference between the temperature of the outside air and the windshield could cause the outer surface of the windshield to fog up, causing loss of visibility. In this case, set the mode selection to the  position and fan speed control to the lower speed.

- For maximum defrosting, set the temperature control to the extreme right/hot position and the fan speed control to the highest speed.
- If warm air to the floor is desired whilst defrosting or defogging, set the mode to the floor-defrost position.
- Before driving, clear all snow and ice from the windscreen, rear window, outside rear view mirrors, and all side windows.
- Clear all snow and ice from the bonnet and air inlet in the cowl grill to improve heater and defroster efficiency and to reduce the probability of fogging up the inside of the windshield.

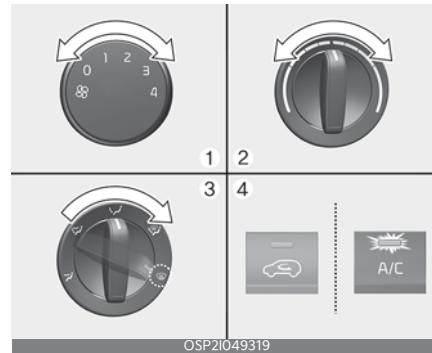

## Defogging inside windscreen with manual climate control system

Type A

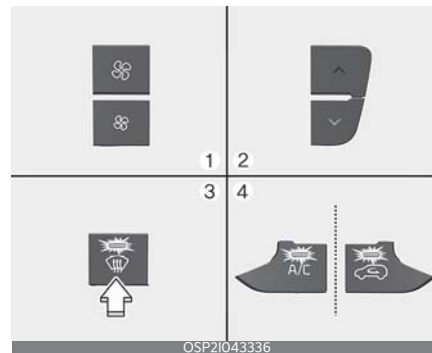

Type B





1. Select any fan speed except "0" position.
2. Select desired temperature.
3. Select the  or  position.
4. The outside (fresh) air and air conditioning will be selected automatically. If the air conditioning and outside (fresh) air position are not selected automatically, press the corresponding button manually.

### Defrosting outside windscreen with manual climate control system

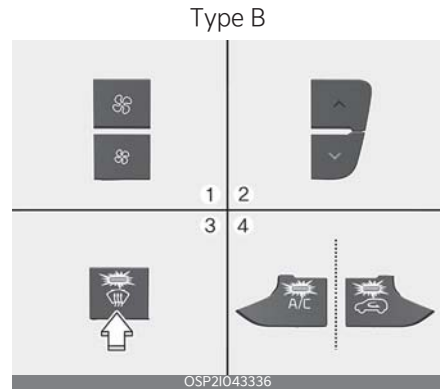
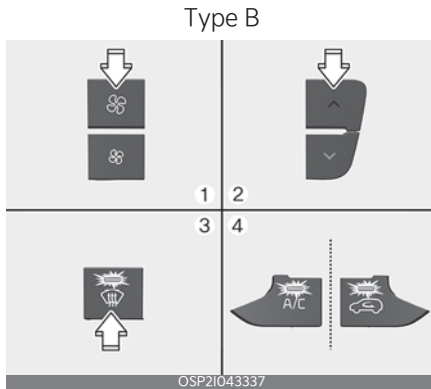
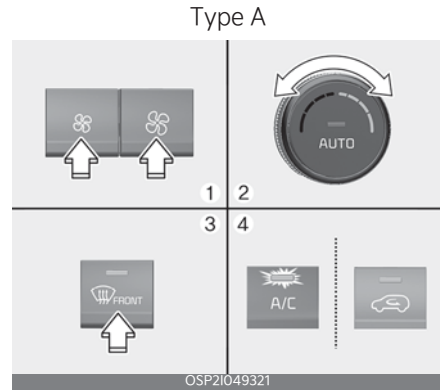
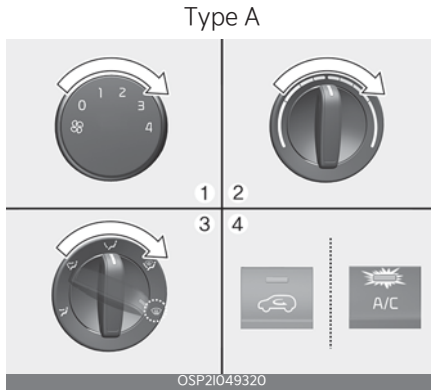
### Defogging inside windscreen with the automatic climate control



1. Set the fan speed to the highest (extreme right) position.
2. Set the temperature to the extreme hot position.
3. Select the  position.
4. The outside (fresh) air and air conditioning will be selected automatically.

1. Set the fan speed to the desired position.
2. Select desired temperature.
3. Press the defroster button (.
4. The outside (fresh) air position will be selected automatically and the air conditioning will turn on according to the detected ambient temperature. If the air conditioning and outside (fresh) air position are not selected automatically, adjust the corresponding button manually. If the  position is



4

selected, lower fan speed is adjusted to a higher fan speed.

### Defrosting outside windscreen with automatic climate control

Type A

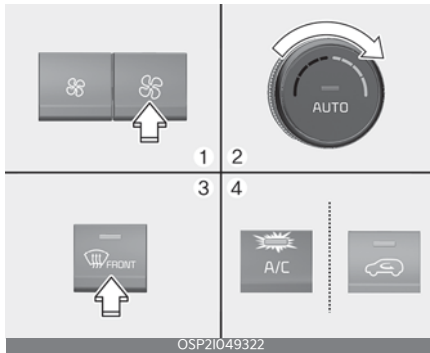

OSP21049322

Type B

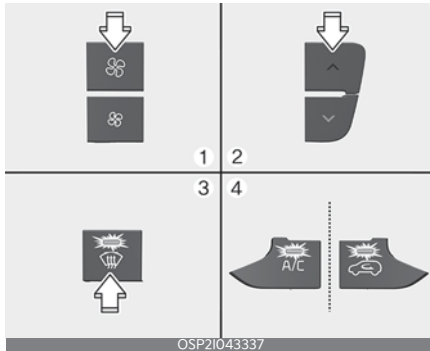

OSP21043337

1. Set the fan speed to the highest position.
2. Set the temperature to the extreme hot (HI) position.
3. Press the defroster button (🚗).
4. The outside (fresh) air position will be selected automatically and the air conditioning will turn on according to the detected ambient temperature.

### Storage compartment

These compartments can be used to store small items required by the driver or passengers.

#### ⚠ CAUTION

- To avoid possible theft, do not leave valuables in the storage compartment.
- Always keep the storage compartment covers closed whilst driving. Do not attempt to place so many items in the storage compartment that the storage compartment cover cannot close securely.

#### ⚠ WARNING

##### Flammable materials

Do not store, propane cylinders or other flammable/explosive materials in the vehicle. These items may catch fire and/or explode if the vehicle is exposed to hot temperatures for extended periods.

### Centre console storage

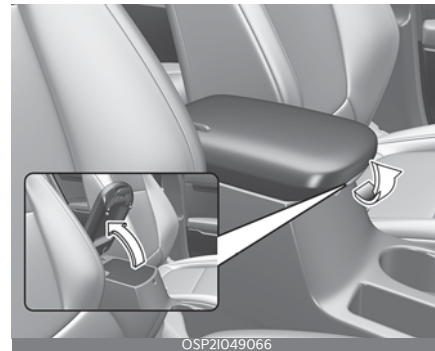

To open the centre console storage:

- Pull up the cover.

## Glove box



To open the glove box:

- Pull the handle and the glove box will automatically open.

Close the glove box after use.

### **⚠ WARNING**

#### **Glove Box**

To reduce the risk of injury in an accident or sudden stop, always keep the glove box door closed whilst driving.

### **⚠ CAUTION**

Do not keep food in the glove box for a long time.

## Sunglass holder



To open the sunglasses holder:

- Press the cover and the holder will slowly open.

Place your sunglasses with the lenses facing out. To close the sunglasses holder push it up.

### **⚠ WARNING**

- Do not keep objects except sunglasses inside the sunglasses holder. Such objects can be thrown from the holder in the event of a sudden stop or an accident, possibly injuring the passengers in the vehicle.
- Do not open the sunglasses holder whilst the vehicle is moving. The rear view mirror of the vehicle can be blocked by an opened sunglasses holder.
- Do not put the glasses forcibly into a sunglasses holder to prevent breakage or deformation of the glasses. It may cause personal injury if you try to open it forcibly when the glasses are jammed in the holder.



### Luggage net holder (if equipped)



To keep items from shifting in the cargo area, you can use the 4 holders located in the cargo area to attach the luggage net.

#### **⚠ CAUTION**

To prevent damage to the goods or the vehicle, be careful when carrying fragile or bulky objects in the luggage compartment.

#### **⚠ WARNING**

Avoid eye injury. DO NOT overstretch the luggage net, ALWAYS keep your face and body out of the luggage net's recoil path. DO NOT use when the strap has visible signs of wear or damage.

### Luggage board

You can place first aid kit, reflector triangle, etc. under the luggage board.



1. Grasp the lift strap on the top of the cover and lift it.
2. Fold the rear part of luggage board frontward.
3. Lift up luggage board frontward (Luggage board stand itself)

## Interior features

There are various features inside the vehicle for the convenience of the occupants.

### Ambient light and Sound mood lamp (if equipped)

The Ambient light and Sound mood lamps (if equipped) are applied to the front passenger's crash pad and front door speakers.

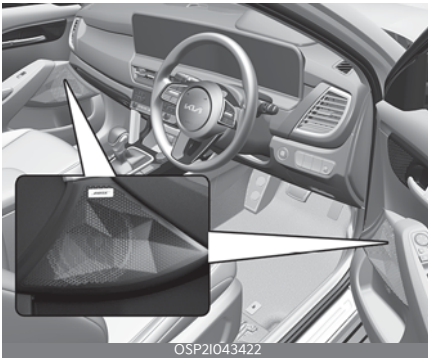

When the headlamp light is on, the ambient light is on at the same time. Sound mood lamps (if equipped) could be set in the audio or infotainment menu. Refer to the audio section of this manual and the infotainment manual for details.

### Ashtray (if equipped)



- To use the ashtray, open the cover.
- To clean or empty the ashtray, pull it out. Use the ashtray by leaning it to the cup holder right beside.

#### ⚠ WARNING

Ashtray use

- Do not use the vehicle's ashtrays as waste receptacles.
- Putting lit cigarettes or matches in an ashtray with other combustible materials may cause a fire.

### Cup holder

Front

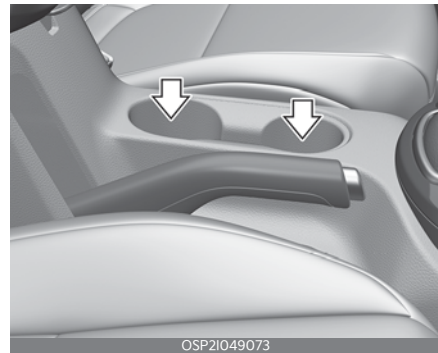

## Rear (if equipped)



Cups or small beverage cans may be placed in the cup holders.

**⚠ WARNING**

**Hot liquids**

- Do not place uncovered cups with hot liquid in the cup holder whilst the vehicle is in motion. If the hot liquid spills, you burn yourself. Such a burn to the driver could lead to loss of control of the vehicle.
- To reduce the risk of personal injury in the event of sudden stop or collision, do not place uncovered or unsecured bottles, glasses, cans, etc., in the cup holder whilst the vehicle is in motion.

**⚠ WARNING**

Keep cans or bottles out of direct sun light and do not put them in a vehicle that is heated up. It may explode.

**\* NOTICE**

- Keep your drinks sealed whilst driving to prevent spilling your drink. If liquid spills, it may get into the vehicle's electrical/electronic system and damage electrical/electronic parts.

- When cleaning spilled liquids, do not dry the cup holder at high temperature. This may damage the cup holder.

**Sliding armrest (if equipped)**

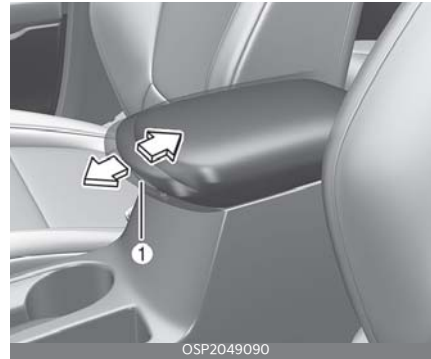

To move forward:

- Grab the front portion of the armrest (1) and pull it forward

**⚠ WARNING**

Do not grab the front portion of the armrest (1) when moving the armrest rearward. It may pinch your fingers.

To move rearward:

- Push the armrest rearward with your palm.

## Air ventilation seat (if equipped)

Front seat

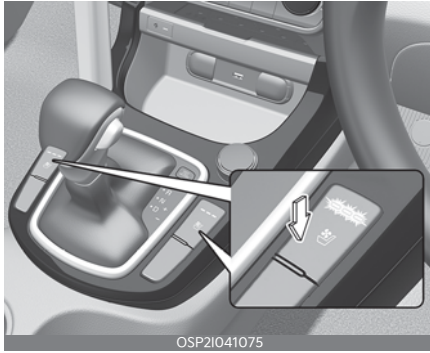

The temperature setting of the seat changes according to the switch position.

- To ventilate your seat cushion, press the switch.

Each time you press the switch, the airflow will change as follows:

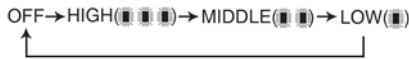

The seat warmer (with air ventilation) defaults to the OFF position whenever the ENGINE START/STOP button is turned on.

### ⚠ CAUTION

#### Seat damage

When cleaning the seats, do not use an organic solvent such as paint thinner, benzene, alcohol and petrol. Doing so may damage the air ventilation seat.

### \* NOTICE

To prevent damage to the air ventilation seat:

- Use the air ventilation seat ONLY when the climate control system is on.

Using the air ventilation seat for prolonged periods of time with the climate control system off could cause the air ventilation seat malfunction.

- Never use a solvent such as paint thinner, benzene, alcohol or petrol to clean the seats.
- Avoid spilling liquids on the surface of the front seats and seatbacks. This may cause the air vent holes to become blocked and not work properly.
- Do not place materials such as plastic bags or newspapers under the seats. They may block the air intake causing the air vents to not work properly.
- Do not change the seat covers. It may damage the air ventilation seat.
- If the air vents do not operate, restart the vehicle. If there is no change, have the vehicle inspected by a professional workshop. Kia recommends to visit an authorised Kia dealer/service partner.



4

## Sun visor

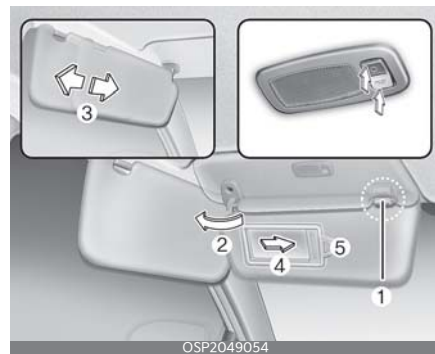

Use the sun visor to shield direct light through the front or side windows.

- To use the sun visor, pull it downward.

- To use the sun visor for the side window, pull it downward, unsnap it from the bracket (1) and swing it to the side (2). You can slide the sun visor if necessary (3). (if equipped)
- To use the vanity mirror, pull down the visor and slide the mirror cover (4).

The ticket holder (5) is provided for holding a tollgate ticket.

**⚠ WARNING**

For your safety, do not block your view when using the sun visor.

**\* NOTICE**

Do not put several tickets in the ticket holder at one time. This could cause damage to the ticket holder.

**Power outlet**

The power outlet is designed to provide power for mobile telephones or other devices designed to operate with vehicle electrical systems.

Front



The devices should draw less than 20 amps with the vehicle on.

**⚠ WARNING**

- Use the power outlet only when the vehicle is on and remove the accessory plug after use. Using the accessory plug for prolonged periods of time with the vehicle off could cause the battery to discharge.
- Only use 12 V electric accessories which are less than 20 A in electric capacity.
- Adjust the air-conditioner or heater to the lowest operating level when using the power outlet.
- Close the cover when not in use.
- Some electronic devices can cause electronic interference when plugged into a vehicle's power outlet. These devices may cause excessive audio static and malfunctions in other electronic systems or devices used in your vehicle.
- Push the plug in as far as it will go. If good contact is not made, the plug may overheat and the fuse may open.
- Plug in battery equipped electronic devices with reverse current protection. The current from the battery may flow into the vehicle's electrical/electronic system and cause system malfunction.

**⚠ WARNING**

**Electric shock**

Do not put a finger or a foreign object (pen, etc.) into a power outlet and do not touch with a wet hand. You may get an electric shock.

**⚠ CAUTION**

Do not connect another vehicle's Tire Mobility Kit (TMK) to the power outlet.

The unmatched power requirement between the vehicle power outlet and the tire mobility kit can cause fire or circuit damage within the vehicle and the Tire Mobility Kit.

### USB charger

The USB car charger allows drivers to charge their digital devices like smartphone, and PC tablets.

Front



OSP21041078

Rear



OSP21043079

Connect the cable to the USB port, charging will begin.

The USB car charger is available with either the ACC or the ignition on. We recommend you connect the USB port and digital devices with the engine running.

See the display screen of the device to check its charging process completion. Your smartphone or table PC could get heated up whilst charging. This is no reason to worry, as it doesn't impact life or functions of the device. For the safety reason, charging can be stopped if the battery gets heated up to a certain point of temperature that the devices can be negatively affected. Charging some digital devices is not available or requires special dedicated adapters if their charging methods don't fit the way the USB car charger works. Quick Charge 2.0 is available on the smartphone or the table PC equipped with fast charging capabilities. The applicable is as follows: (<https://www.qualcomm.com/documents/quick-charge-device-list>)

The smartphone or PC tablet without fast charging is charged at a regular speed.

Rated output:

- Digital devices with fast charging:
  - 9.0 V, 1.67 A
- Digital devices with normal charging:
  - 5.0 V, 2.1 A

### ⚠ CAUTION

- Use the USB car charger with the ignition on. Otherwise, Vehicle battery can be discharged.
- Use the official USB cable of the manufacturer of the digital device to be charged.
- Make sure that any foreign object, drinks, and water do not come into contact with the USB car charger. Water or foreign object can damage the USB charger.
- Do not use the device those current consumption exceeds 2.1 A.

- Do not connect an electrical device that generates excessive electromagnetic noise to the USB car port. If you do so, noise can be caused or vehicle electronic devices can be interrupted whilst audio or AV is on.
- If the charger is connected incorrectly, it can cause serious damage on the devices. Please note that damages due to incorrect usage are not covered by warranty service.

### Wireless smart phone charging system (if equipped)

A wireless smart phone charging system is located in front of the centre console.

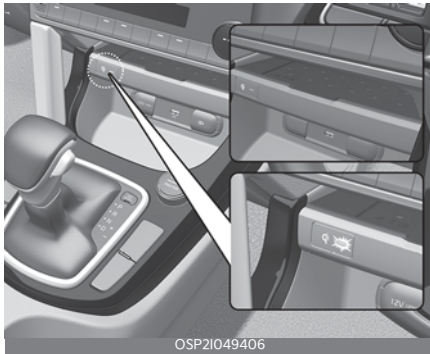

Firmly close all doors, and turn the ignition to ACC or IGN ON. To start wireless charging, place the smart phone equipped with wireless charging function on the wireless charging pad.

For best wireless charging results, place the smart phone on the centre of the charging pad.

The wireless charging system is designed for one smart phone equipped with Qi only. Please refer to the smart phone accessory cover or the smart phone manufacturer homepage to

check whether your smart phone supports Qi function.

#### **WARNING**

If any metallic object such as coins is located between the wireless charging system and the smart phone, the charging may be disrupted. Also, the metallic object may heat up.

### Wireless smart phone charging

1. Remove any object on the smart phone charging pad including the smart key. If there is any foreign object on the pad other than a smart phone, the wireless charging function may not operate properly.
2. Place the smart phone on the centre of the wireless charging pad.
3. The indicator light will change to amber once the wireless charging begins. After the charging is complete, the orange light will change to green.
4. You can choose to turn the wireless charging function to either ON or OFF by selecting the USM on the instrument cluster. (Please refer to "Instrument cluster" on page 4-41 for details).

If the wireless charging does not work, gently move your smart phone around the pad until the charging indicator light turns amber. Depending on the smart phone, the charging indicator light may not turn green even after the charging is complete.

If the wireless charging is not functioning properly, the orange light will blink and flash for ten seconds then turn off. In such cases, remove the smart phone from the pad and replace it on the pad

again, or double check the charging status.

If you leave the smart phone on the charging pad when the vehicle ignition is in OFF, the vehicle will alert you through warning messages and sound (applicable for vehicles with voice guidance function) after the 'Good bye' function on the instrument cluster ends.

### \* NOTICE

For some manufacturers' smart phones, the system may not warn you even though the smart phone is left on the wireless charging unit. This is due to the particular characteristic of the smart phone and not a malfunction of the wireless charging.

### ▲ CAUTION

- When the interior temperature of the wireless charging system rises above a set temperature, the wireless charging will cease to function. After the interior temperature drops below the threshold, the wireless charging function will resume.
- If there is any metallic object between the smart phone and the wireless charging pad, immediately remove the smart phone. Remove the metallic object after it has completely cooled down.
- The wireless charging may not function properly when there is a heavy accessory cover on the smart phone.
- The wireless charging will stop when using the wireless smart key search function to prevent radio wave disruption.
- The wireless charging will stop when the smart key is moved out of the vehicle with the ignition in ON.
- The wireless charging will stop when any of the doors is opened (applicable for vehicles equipped with smart keys).
- The wireless charging will stop when the vehicle is turned OFF.
- The wireless charging will stop when the smart phone is not in complete contact with the wireless charging pad.
- Items equipped with magnetic components such as credit card, telephone card, bankbook, any transportation ticket and such may become damaged during wireless charging.
- Place the smart phone on the centre of the charge pad for best results. The smart phone may not charge when placed near the rim of the charging pad. When the smart phone does get charged, it may heat up excessively.
- For smart phones without builtin wireless charging system, an appropriate accessory has to be equipped.
- Smart phones of some manufacturers may display messages on weak current. This is due to the particular characteristic of the smart phone and does not imply a malfunction on wireless charging function.
- The indicator light of some manufacturers' smart phones may still be amber after the smart phone is fully charged. This is due to the particular characteristic of the smart phone and not a malfunction of the wireless charging.
- When any smart phone without a wireless charging function or a metallic object is placed on the charging pad, a small noise may sound. This small sound is due to the vehicle dis-



cerning compatibility of the object placed on the charging pad. It does not affect your vehicle or the smart phone in any way.

- The wireless mobile phone charging system may not support certain mobile phones, which are not verified for the Qi specification (  ).
- For certain mobile phones with their own protection, the wireless charging speed may decrease and the wireless charging may stop.
- For Flip type mobiles when using wireless charging, place the mobile phone only in folded position with device back placed on the center of wireless charging unit.
- **Liquid on Wireless Smart Phone Charger**  
To prevent liquid from damaging the wireless smart phone charging system in your vehicle, be sure not to spill liquid over the charging system when charging your phone.

### Coat hook

A Coat hook is next to the rear grab handle.



\* This actual feature may differ from the illustration.

### CAUTION

#### Hanging clothing

Do not hang heavy clothes, since they may damage the hook.

### WARNING

Do not hang other objects such as hangers or hard objects except clothes. Also, do not put heavy, sharp or breakable objects in the clothing's pockets. In an accident or when the curtain air bag is inflated, it may cause vehicle damage or body injury.



## Floor mat anchor(s) (if equipped)



When using a floor mat on the front floor carpet, make sure it attaches to the floor mat anchor(s) in your vehicle. This keeps the floor mat from sliding forward.

### **⚠ WARNING**

#### **After market floor mat**

- Do not install after market floor mats that are not capable of being securely attached to the vehicle's floor mat anchors. Unsecured floor mats can interfere with pedal operation.
- Use floor mats not too thick and designed to be properly secured on the floor to avoid the interference with pedals. Make sure that installing the floor mats without removing plastic films on carpets may damage or break floor mat fix rings in the mats to be unsecured. Especially for a driver's seat, the unsecured mats may cause unintended acceleration/brake. Ensure to remove all the plastic films on the carpets before installing the mats.

The following must be observed when installing ANY floor mat to the vehicle.

- Ensure that the floor mats are securely attached to the vehicle's floor mat anchor(s) before driving the vehicle.
- Do not use ANY floor mat that cannot be firmly attached to the vehicle's floor mat anchors.
- Do not stack floor mats on top of one another (e.g., all-weather rubber mat on top of a carpeted floor mat). Only a single floor mat should be installed in each position.

## Cargo area cover (if equipped)

Use the cargo area cover to hide items stored in the cargo area.

### Removal and installation

To remove the cargo area cover:

1. Remove straps from both sides of the cargo area cover.



2. Whilst lifting the cover up, hold the area near the front slots. Then, pull up the cover at approximately 45° angle.

#### **⚠ WARNING**

Do not place objects on the cargo area cover. Such objects may be thrown about inside the vehicle and possibly injure vehicle occupants during an accident or when braking.

#### **⚠ CAUTION**

Since the cargo area cover may be damaged or malformed, do not put luggage on it when it is used.

## Side curtain

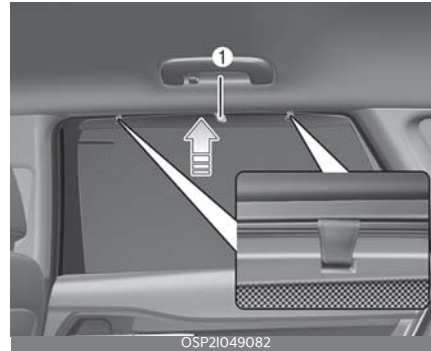

To use the side curtain:

1. Lift the curtain by the handle (1).
2. Hang the curtain on both sides of the hook.

If the curtain is hung on one side, the curtain may be wrinkled.

#### **⚠ CAUTION**

- Do not hang any other object except the side curtain on the hooks.
- If you pull the door curtain or apply force to return the curtain to its original position after use, you may find the curtain wrinkled or out of shape. To lower the door curtain, be sure to put the handle downward and slowly return the curtain to its original position.
- Curtains may not work properly if foreign objects (coins, toys, cookies, etc.) are stuck in the door. Be careful that the foreign objects do not get into the door.

## Exterior features

### Roof rack (if equipped)

If the vehicle has a roof rack, you can load cargo on top of your vehicle.



Crossbars and fixing components needed to install the roof rack on your vehicle may be obtained from an authorised Kia dealer/service partner or other qualified shop.

#### \* NOTICE

- The crossbars (if equipped) should be placed in the proper load carrying positions prior to placing items onto the roof rack.
- If the vehicle is equipped with a sunroof, be sure not to position cargo onto the roof rack in such a way that it could interfere with sunroof operation.
- When the roof rack is not being used to carry cargo, the crossbars may need to be repositioned if wind noise is detected.

#### ⚠ CAUTION

- When carrying cargo on the roof rack, take the necessary precautions to

make sure the cargo does not damage the roof of the vehicle.

- When carrying large objects on the roof rack, make sure they do not exceed the overall roof length or width.
- When you are carrying cargo on the roof rack, do not operate the sunroof. (if equipped)

#### ⚠ WARNING

- The following specification is the maximum weight that can be loaded onto the roof rack. Distribute the load as evenly as possible across the crossbars (if equipped) and roof rack and secure the load firmly.

ROOF LOAD	80 kg EVENLY DISTRIBUTED
-----------	-----------------------------

Loading cargo or luggage in excess of the specified weight limit on the roof rack may damage your vehicle.

- The vehicle centre of gravity will be higher when items are loaded onto the roof rack. Avoid sudden starts, braking, sharp turns, abrupt manoeuvres or high speeds that may result in loss of vehicle control or rollover resulting in an accident.
- Always drive slowly and turn corners carefully when carrying items on the roof rack. Severe wind updrafts, caused by passing vehicles or natural causes, can cause sudden upward pressure on items loaded on the roof rack. This is especially true when carrying large, flat items such as wood panels or mattresses. This could cause the items to fall off the roof rack and cause damage to your vehicle or others around you.



4

- To prevent damage or loss of cargo whilst driving, check frequently before or whilst driving to make sure the items on the roof rack are securely fastened.

## Infotainment system

### Audio system

#### \* NOTICE

If you install an aftermarket HID head lamp, your vehicle's audio and electronic device may malfunction.

### Antenna



The roof antenna transmits and receives wireless signals such as AM/FM, Sirius XM, GNSS, etc.

\* The signals which antenna can transmit and receive vary by the vehicle option.

### USB port

You can use a USB port to plug in a USB.



## How vehicle radio works

### FM reception

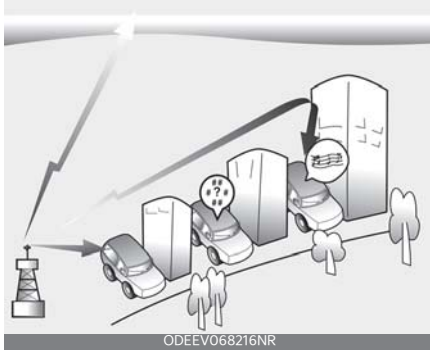

AM and FM radio signals are broadcast from transmitter towers located around your city. They are intercepted by the radio antenna on your vehicle. This signal is then processed by the radio and sent to your vehicle speakers.

However, in some cases the signal coming to your vehicle may not be strong and clear.

This can be due to factors, such as the distance from the radio station, closeness of other strong radio stations or the presence of buildings, bridges or other large obstructions in the area.

### AM reception

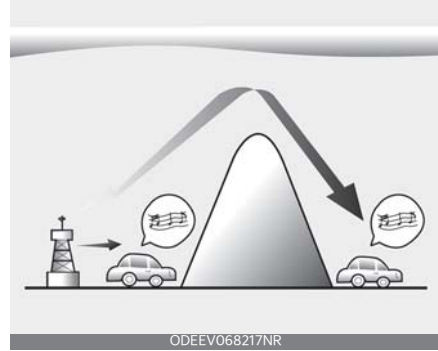

AM broadcasts can be received at greater distances than FM broadcasts. This is because AM radio waves are transmitted at low frequencies. These long distance, low frequency radio waves can follow the curvature of the earth rather than travelling straight. In addition, they curve around obstructions resulting in better signal coverage.

### FM radio station

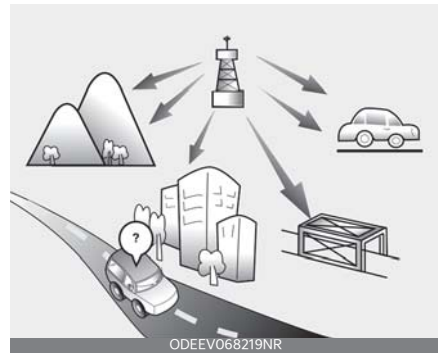

FM broadcasts are transmitted at high frequencies and do not bend to follow the earth's surface. Because of this, FM broadcasts generally begin to fade within short distances from the station. Also, FM signals are easily affected by buildings, mountains, and obstructions.

This can lead to undesirable or unpleasant listening conditions which might lead you to believe a problem exists with your radio.

The following conditions are normal and do not indicate radio trouble:

- **Fading** - As your vehicle moves away from the radio station, the signal will weaken and sound will begin to fade. When this occurs, we suggest that you select another station with a stronger signal.

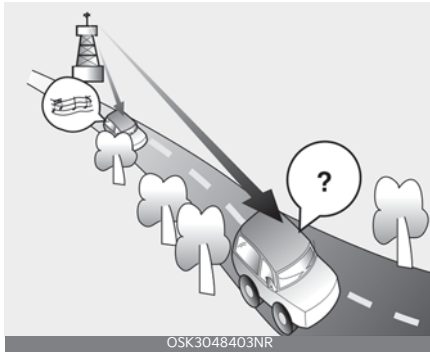

- **Flutter/Static** - Weak FM signals or large obstructions between the transmitter and your radio can disturb the signal causing static or fluttering noises to occur. Reducing the treble level may lessen this effect until the disturbance clears.
- **Station Swapping** - As an FM signal weakens, another more powerful signal near the same frequency may begin to play. This is because your radio is designed to lock onto the clearest signal. If this occurs, select another station with a stronger signal.

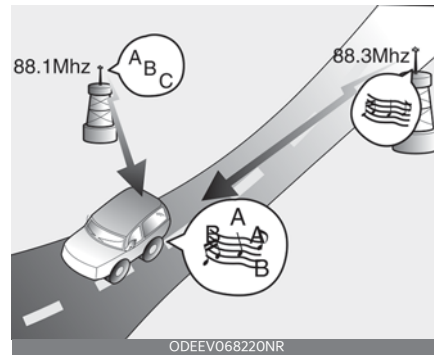

- **Multi-Path Cancellation** - Radio signals being received from several directions can cause distortion or fluttering. This can be caused by a direct and reflected signal from the same station, or by signals from two stations with close frequencies. If this occurs, select another station until the condition has passed.

### Using a mobile phone or a two-way radio

When a mobile phone is used inside the vehicle, noise may be produced from the audio system. This does not mean that something is wrong with the audio equipment. In such a case, try to operate mobile devices as far from the audio equipment as possible.

#### **CAUTION**

When using a communication system such as a mobile phone or a radio set inside the vehicle, a separate external antenna must be fitted. When a mobile phone or a radio set is used with only the internal antenna, it may interfere with the vehicle's electrical system and adversely affect the safe operation of the vehicle.

**⚠ WARNING**

**Cell phone use**

Do not use a mobile phone whilst driving. Stop at a safe location to use a mobile phone.

---



4



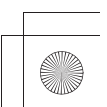
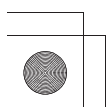
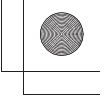
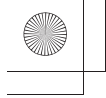

# Driving your vehicle **5**

<b>Be sure the exhaust system does not leak.....</b>	<b>5-3</b>
<b>Before driving .....</b>	<b>5-3</b>
<b>Key positions.....</b>	<b>5-5</b>
• Ignition switch position.....	5-5
• Starting the engine.....	5-6
• Stopping the petrol engine/diesel engine (Manual Transmission/Intelligent Manual Transmission (iMT)).....	5-9
<b>ENGINE START/STOP button.....</b>	<b>5-9</b>
• Illuminated ENGINE START/STOP button.....	5-9
• ENGINE START/STOP button position .....	5-9
• Starting the engine.....	5-12
<b>Manual transmission .....</b>	<b>5-16</b>
• Manual transmission operation.....	5-16
• Good driving practices .....	5-18
<b>Intelligent Manual transmission .....</b>	<b>5-19</b>
• Intelligent Manual Transmission (iMT) operation.....	5-20
• Transmission high temperature .....	5-21
• Transmission overheated.....	5-22
• Good driving practices .....	5-22
<b>Automatic transmission.....</b>	<b>5-23</b>
• Automatic transmission operation .....	5-23
• Shift lock system .....	5-27
• Good driving practices .....	5-28
<b>Dual clutch transmission .....</b>	<b>5-29</b>
• Shift lever type .....	5-29
• Characteristics of Dual clutch transmission.....	5-31
• DCT warning messages .....	5-33
<b>Intelligent variable transmission (IVT).....</b>	<b>5-35</b>
• Intelligent Variable Transmission (IVT) operation .....	5-35
• Shift lock system .....	5-38

# 5 Driving your vehicle

- Good driving practices ..... 5-38
- Brake system ..... 5-39**
  - Power brakes ..... 5-39
  - Parking brake ..... 5-41
  - Electronic Parking Brake (EPB)..... 5-43
  - AUTO HOLD ..... 5-46
  - Anti-lock Brake System (ABS) ..... 5-48
  - Electronic Stability Control (ESC) system..... 5-50
  - Vehicle Stability Management (VSM) system ..... 5-53
  - Hill-start Assist Control (HAC) ..... 5-54
  - Emergency Stop Signal (ESS) ..... 5-54
  - Brake Assistant System (BAS) ..... 5-55
  - Good braking practices..... 5-55
- Idle Stop and Go (ISG) system ..... 5-56**
  - Auto stop ..... 5-57
  - Auto start ..... 5-58
  - Operating conditions of ISG system..... 5-58
  - ISG system indicator ..... 5-59
- Drive mode integrated control system ..... 5-61**
  - Traction control..... 5-62
- Economical operation..... 5-65**
- Special driving conditions ..... 5-66**
- Winter driving ..... 5-70**
- Vehicle weight..... 5-74**

## Driving your vehicle

### Be sure the exhaust system does not leak.

The exhaust system should be checked whenever the vehicle is raised to change the oil or for any other purpose.

If you hear a change in the sound of the exhaust or if you drive over something that strikes the underneath side of the vehicle, have the exhaust system checked as soon as possible by a professional workshop. Kia recommends to visit an authorised Kia dealer/service partner.

#### WARNING

##### Engine exhaust

Do not inhale exhaust fumes or leave your engine running in a enclosed area for a prolonged time. Exhaust fumes contain carbon monoxide, a colourless, odourless gas that can cause unconsciousness and death by asphyxiation.

#### WARNING

##### Open tailgate

Do not drive with the tailgate open. Poisonous exhaust gases can enter the passenger compartment. If you must drive with the tailgate open proceed as follows:

1. Close all windows.
2. Open side vents.
3. Set the air intake control at "Fresh", the air flow control at "Floor" or "Face" and the fan at the highest speed.

## Before driving

Before getting into the vehicle, you should examine the car and its surroundings. After getting into the vehicle, you should check a number of things before driving.

### Before entering vehicle

- Be sure that all windows, outside mirror(s), and outside lights are clean.
- Check the condition of the tyres.
- Check under the vehicle for any sign of leaks.
- Be sure there are no obstacles behind you if you intend to back up.

### Necessary inspections

Fluid levels, such as engine oil, engine coolant, brake fluid, and washer fluid should be checked on a regular basis, at the exact interval depending on the fluid. Further details are provided in "Maintenance" on page 8-4.

#### WARNING

##### Distracted driving

Focus on the road whilst driving. The driver's primary responsibility is in the safe and legal operation of the vehicle. Use of any handled devices, other equipment or vehicle systems that distract the driver should not be used during vehicle operation.

### Before starting

- Close and lock all doors.
- Position the seat so that all controls are easily reached.
- Buckle your seat belt.

- Adjust the inside and outside rearview mirrors.
- Be sure that all lights work.
- Check all gauges.
- Check the operation of warning lights when the ENGINE START/STOP button is turned to the ON position.
- Release the parking brake and make sure the brake warning light is not on.

For safe operation, be sure you are familiar with your vehicle and its equipment.

#### WARNING

##### **Fire risk**

When you intend to park or stop the vehicle with the engine on, be careful not to depress the accelerator pedal for a long period of time. It may overheat the engine or exhaust system and cause fire.

#### WARNING

##### **Check surroundings**

Always check the surrounding areas near your vehicle for people, especially children, before putting a vehicle into D (Drive) or R (Reverse).

#### WARNING

##### **Loose objects**

Securely store items in your vehicle. When you make a sudden stop or turn the steering wheel rapidly, loose objects may drop on the floor and it could interfere with the operation of the foot pedals, possibly causing an accident.

#### WARNING

##### **Driving whilst intoxicated**

Do not drive whilst intoxicated. Drinking and driving is dangerous. Even a small amount of alcohol will affect your reflexes, perceptions and judgment.

Driving whilst under the influence of drugs is as dangerous as or more dangerous than driving drunk.

#### WARNING

##### **Proper footwear**

Always wear appropriate shoes when operating your vehicle. Unsuitable shoes (high heels, ski boots, sandals, etc.) may interfere with your ability to use the brake and accelerator pedals.

## Key positions

### Ignition switch position



#### LOCK (1)

The steering wheel locks to protect against theft. The ignition key can be removed only in the LOCK position.

#### ACC (Accessory) (2)

The steering wheel is unlocked and electrical accessories are operative.

#### \* NOTICE

If difficulty is experienced turning the ignition switch to the ACC position, turn the key whilst turning the steering wheel right and left to release the tension.

#### ON (3)

The warning lights can be checked before the engine is started. This is the normal running position after the engine is started.

Do not leave the ignition switch ON if the engine is not running to prevent battery discharge.

#### START (4)

Turn the ignition switch to the START position to start the engine. The engine will crank until you release the key; then it returns to the ON position. The brake warning light can be checked in this position.

#### ⚠ WARNING

#### Ignition switch

- Never turn the ignition switch to LOCK or ACC whilst the vehicle is moving. This would result in loss of directional control and braking function, which could cause an accident.
- The anti-theft steering column lock is not a substitute for the parking brake. Before leaving the driver's seat, always make sure the shift lever is engaged in 1st gear for the manual Transmission/Intelligent Manual Transmission, set the parking brake fully and shut the engine off. Unexpected and sudden vehicle movement may occur if these precautions are not taken.
- Never reach for the ignition switch, or any other controls through the steering wheel whilst the vehicle is in motion. The presence of your hand or arm in this area could cause a loss of vehicle control, an accident and serious bodily injury or death.
- Do not place any movable objects around the driver's seat as they may move whilst driving, interfere with the driver and lead to an accident.

5

## Starting the engine

### ⚠ WARNING

- Always wear appropriate shoes when operating your vehicle. Unsuitable shoes (high heels, ski boots, etc.) may interfere with your ability to use the brake and accelerator pedal, and the clutch. (if equipped)
- Do not start the vehicle with the accelerator pedal depressed. The vehicle can move and lead to an accident.
- Wait until the engine rpm is normal. The vehicle may suddenly move if the brake pedal is released when the rpm is high.

## Starting the petrol engine

1. Make sure the parking brake is applied.
2. **Manual Transmission** - Depress the clutch pedal fully and shift the transmission into Neutral. Keep the clutch pedal and brake pedal depressed whilst turning the ignition switch to the start position.
3. Turn the ignition switch to START and hold it there until the engine starts (a maximum of 10 seconds), then release the key.

It should be started **without depressing the accelerator pedal.**

**Intelligent Manual Transmission (iMT)** - Shift the transmission into Neutral. Keep the brake pedal depressed whilst turning the ignition switch to the start position.

If you turn the ignition switch to the start position without depressing the brake pedal, the engine will not start, and it will be displayed on the cluster as in the following pop-up.

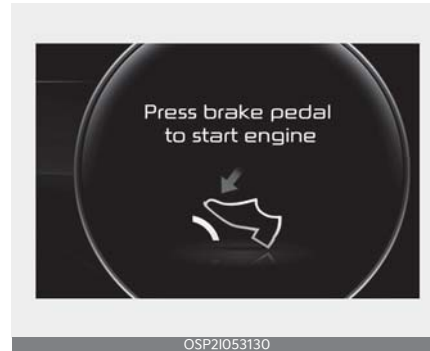

When the shift lever is not placed in N (Neutral), the following pop-up will be displayed on the cluster.

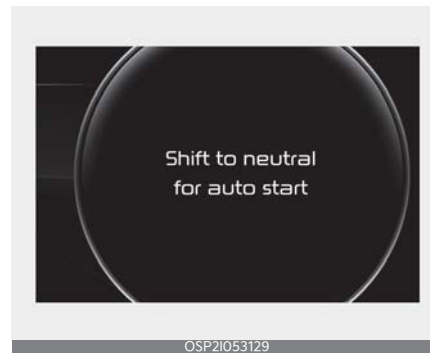

4. Do not wait for the engine to warm up whilst the vehicle remains stationary. Start driving at moderate engine speeds. (Steep accelerating and decelerating should be avoided.)

### **Automatic transmission/Intelligent variable transmission**

1. Make sure the parking brake is applied.
2. Place the transmission shift lever in P (Park). Depress the brake pedal fully. You can also start the engine when the shift lever is in the N (Neutral) position.
3. Turn the ignition switch to START and hold it there until the engine starts (a

maximum of 10 seconds), then release the key.

It should be started **without depressing the accelerator pedal.**

4. Do not wait for the engine to warm up whilst the vehicle remains stationary. Start driving at moderate engine speeds. (Steep accelerating and decelerating should be avoided.)

### Starting the diesel engine

To start the diesel engine when the engine is cold, it has to be pre-heated before starting the engine and then have to be warmed up before starting to drive.

1. Make sure the parking brake is applied.
2. **Manual Transmission** - Depress the clutch pedal fully and shift the transmission into Neutral. Keep the clutch pedal and brake pedal depressed.

**Intelligent Manual Transmission (iMT)** - Shift the transmission into Neutral. Keep the brake pedal depressed whilst turning the ignition switch to the start position.

If you turn the ignition switch to the start position without depressing the brake pedal, the engine will not start, and it will be displayed on the cluster as in the following pop-up.

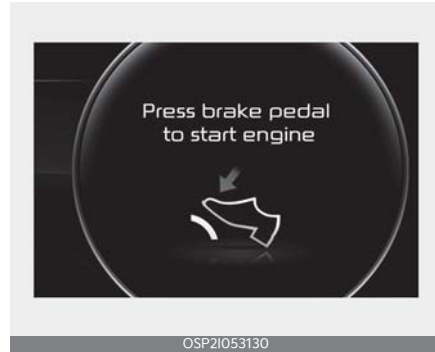

When the shift lever is not placed in N (Neutral), the following pop-up will be displayed on the cluster.

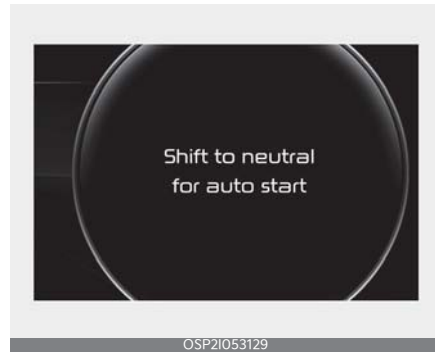

3. Turn the ignition switch to the ON position to pre-heat the engine. Then the glow indicator light will illuminate.

Glow indicator light



4. If the glow indicator light goes out, turn the ignition switch to the START position and hold it there until the engine starts (a maximum of 10 seconds), then release the key.

### Automatic Transmission

1. Make sure the parking brake is applied.



- Place the transmission shift lever in P (Park). Depress the brake pedal fully. You can also start the engine when the shift lever is in the N (Neutral) position.
- Turn the ignition switch to the ON position to pre-heat the engine. Then the glow indicator light will illuminate.

Glow indicator light



- If the glow indicator light goes out, turn the ignition switch to the START position and hold it there until the engine starts (a maximum of 10 seconds), then release the key.

#### \* NOTICE

If the engine does not start within 10 seconds after the preheating is completed, turn the ignition key once more to the LOCK position for 10 seconds, and then to the ON position, in order to pre-heat again.

### Starting and stopping the engine for turbocharger intercooler

- Do not race or accelerate the engine immediately after starting.  
If the engine is cold, idle for several seconds before sufficient lubrication is ensured in the turbocharger unit.
- After high speed or extended driving, requiring a heavy engine load, idle the engine about 1 minute before turning it off.  
This idle time will allow the turbocharger to cool prior to shutting the engine off.

#### ⚠ CAUTION

Do not turn the engine off immediately after it has been subjected to a heavy load. Doing so may cause severe damage to the engine or turbocharger unit.

#### ⚠ CAUTION

If the engine stalls whilst you are in motion, do not attempt to move the shift lever to the P (Park) position. If traffic and road conditions permit, you may put the shift lever in the N (Neutral) position whilst the vehicle is still moving and turn the ignition switch to the START position in an attempt to restart the engine.

#### ⚠ CAUTION

- Do not engage the starter for more than 10 seconds. If the engine stalls or fails to start, wait 5 to 10 seconds before re-engaging the starter. Improper use of the starter may damage it.
- Do not turn the ignition switch to the START position with the engine running. It may damage the starter.

### Stopping the petrol engine/diesel engine (Manual Transmission/ Intelligent Manual Transmission (iMT))

1. Make sure the vehicle is completely stopped and keep the clutch pedal (for manual transmission) and brake pedal depressed.
2. Shift the transmission into Neutral whilst depressing the clutch pedal (for manual transmission) and brake pedal.
3. Engage the parking brake whilst depressing the brake pedal.
4. Turn the ignition key to the LOCK position and remove it.

### ENGINE START/STOP button Illuminated ENGINE START/STOP button



The light will go off after about 30 seconds when the door is closed. It will also go off immediately when the theft-alarm system is armed.

5

### ENGINE START/STOP button position

Your vehicle is equipped with four different ignition positions.

### OFF

#### With Manual Transmission/Intelligent Manual Transmission

To turn off the engine (START/RUN position) or vehicle power (ON position), stop the vehicle then press the ENGINE START/STOP button.

#### With automatic transmission/ Intelligent variable transmission

To turn off the engine (START/RUN position) or vehicle power (ON position), press the ENGINE START/STOP button with the shift lever in the P (Park) position. When you press the ENGINE START/STOP button without the shift

lever in the P (Park) position, the ENGINE START/STOP button will not change to the OFF position but to the ACC position.

### Vehicles equipped with anti-theft steering column lock

The steering wheel locks when the ENGINE START/STOP button is in the OFF position to protect you against theft.

It locks when the door is opened.

If the steering wheel is not locked properly when you open the driver's door, the warning chime will sound. Try locking the steering wheel again. If the problem is not solved, have the system checked by a professional workshop. Kia recommends to visit an authorised Kia dealer/service partner.

In addition, if the ENGINE START/STOP button is in the OFF position after the driver's door is opened, the steering wheel will not lock and the warning chime will sound. In such a situation, close the door. Then the steering wheel will lock and the warning chime will stop.

#### \* NOTICE

If the steering wheel doesn't unlock properly, the ENGINE START/STOP button will not work. Press the ENGINE START/STOP button whilst turning the steering wheel right and left to release the tension.

#### \* NOTICE

You are able to turn off the engine (START/RUN) or vehicle power (ON), only when the vehicle is not in motion.

#### ⚠ CAUTION

In an emergency situation whilst the vehicle is in motion, you are able to turn the engine off and to the ACC position by pressing the ENGINE START/STOP button for more than 2 seconds or 3 times successively within 3 seconds.

If the vehicle is still moving, to restart the vehicle:

- Manual Transmission/Intelligent Manual Transmission - Press the ENGINE START/STOP button with shift lever in neutral and clutch pedal (for manual transmission) depressed.
- Automatic transmission/Intelligent variable transmission - Press the ENGINE START/STOP button when vehicle speed is 5 km/h or over.

### ACC (Accessory)



#### With manual transmission

Press the ENGINE START/STOP button when the button is in the OFF position without depressing the clutch pedal.

**With automatic transmission/  
Intelligent variable transmission/  
Intelligent Manual Transmission**

Press the ENGINE START/STOP button whilst it is in the OFF position without depressing the brake pedal.

The steering wheel unlocks and electrical accessories are operational.

If the ENGINE START/STOP button is in the ACC position for more than 1 hour, the button is turned off automatically to prevent battery discharge.

**ON**

**With manual transmission**

Press the ENGINE START/STOP button when the button is in the ACC position without depressing the clutch pedal.

**With automatic transmission/  
Intelligent variable transmission/  
Intelligent Manual Transmission**

Press the ENGINE START/STOP button whilst it is in the ACC position without depressing the brake pedal.

The warning lights can be checked before the engine is started. Do not leave the ENGINE START/STOP button in the ON position for a long time. The battery may discharge, because the engine is not running.

**START/RUN**

**With manual transmission**

To start the engine, depress the clutch pedal and brake pedal, then press the ENGINE START/STOP button with the shift lever in the N (Neutral) position.

**With Intelligent Manual Transmission (iMT)**

Shift the transmission into Neutral. Keep the brake pedal depressed whilst pressing the ENGINE START/STOP button to the START position.

If the status is changed into ACC, it will be displayed on the cluster as in the following pop-up.

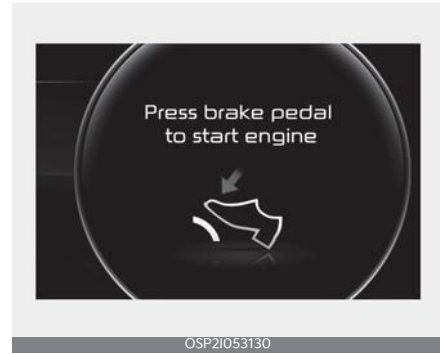

When the shift lever is not placed in N (Neutral), the following pop-up will be displayed on the cluster.

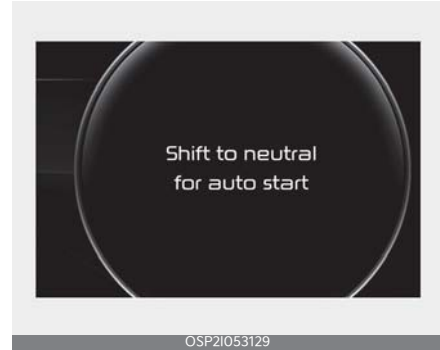

**With automatic transmission/  
Intelligent variable transmission**

To start the engine, depress the brake pedal and press the ENGINE START/STOP button with the shift lever in the P (Park) or the N (Neutral) position. For

your safety, start the engine with the shift lever in the P (Park) position.

### \* NOTICE

If you press the ENGINE START/STOP button without depressing the clutch pedal for manual transmission vehicles or without depressing the brake pedal for automatic transmission/Intelligent variable transmission/Intelligent Manual Transmission vehicles, the engine will not start and the ENGINE START/STOP button changes as follow:

OFF → ACC → ON → OFF or ACC

### \* NOTICE

If you leave the ENGINE START/STOP button in the ACC or ON position for a long time, the battery will discharge.

### ▲ WARNING

- Never press the ENGINE START/STOP button whilst the vehicle is in motion. This would result in loss of directional control and braking function, which could cause an accident and severe damage to the intelligent variable transmission.
- The anti-theft steering column lock is not a substitute for the parking brake. Before leaving the driver's seat, always make sure the shift lever is engaged in P (Park), set the parking brake fully and shut the engine off. Unexpected and sudden vehicle movement may occur if these precautions are not taken.
- Never reach for the ENGINE START/STOP button or any other controls through the steering wheel whilst the vehicle is in motion. The presence of your hand or arm in the area could cause loss of vehicle control, an acci-

dent and serious bodily injury or death.

- Do not place any movable objects around the driver's seat as they may move whilst driving, interfere with the driver and lead to an accident.

## Starting the engine

### ▲ WARNING

- Do not start the vehicle with the accelerator pedal engaged. The vehicle can move and lead to an accident.
- Wait until the engine rpm is normal. The vehicle may suddenly move if the brake pedal is released when the rpm is high.

## Starting the engine with smart key

At the time that the vehicle doors are opened or when the ENGINE START/STOP button is pressed the vehicle will check for the smart key.

If the smart key is not in the vehicle, the "P" indicator and a message "Key is not in the vehicle" will appear on the instrument cluster and LCD window. And if all doors are closed, the chime will sound for 5 seconds. The indicator or warning will turn off whilst the vehicle is moving. Always have the smart key with you.

### ▲ WARNING

The engine will start, only when the smart key is in the vehicle. Never allow children or any person who is unfamiliar with the vehicle touch the ENGINE START/STOP button or related parts. Pushing the ENGINE START/STOP button whilst the smart key is in the vehicle may result in unintended engine activa-

tion and/or unintended vehicle movement.

### ⚠ CAUTION

If the engine stalls whilst the vehicle is in motion, do not attempt to move the shift lever to the P (Park) position. If the traffic and road conditions permit, you may put the shift lever in the N (Neutral) position whilst the vehicle is still moving and press the ENGINE START/STOP button in an attempt to restart the engine.



### \* NOTICE

- If the battery is weak or the smart key does not work correctly, you can start the engine by pressing the ENGINE START/STOP button with the smart key.

When you press the ENGINE START/STOP button directly with the smart key, the smart key should contact the button at a right angle.

- When the stop lamp fuse is blown, you cannot start the engine normally. Replace the fuse with a new one. If it is not possible, you can start the engine by pressing the ENGINE START/STOP button for 10 seconds whilst it is in the ACC position. The

engine can start without pressing the brake pedal. But for your safety always press the brake pedal before starting the engine.

### ⚠ CAUTION

- Do not press the ENGINE START/STOP button for more than 10 seconds except when the stop lamp fuse is blown.
- Do not turn the ignition switch to the START position with the engine running. It may damage the starter.

### Starting the petrol engine

1. Carry the smart key or leave it inside the vehicle.
2. Make sure the parking brake is firmly applied.
3. **Manual Transmission** - Depress the clutch pedal fully and shift the transmission into Neutral. Keep the clutch pedal and brake pedal depressed whilst starting the engine.

### Intelligent Manual Transmission

**(iMT)** - Shift the transmission into Neutral. Keep the brake pedal depressed whilst pressing the ENGINE START/STOP button to the START position.

If you press the ENGINE START/STOP button to the START position without depressing the brake pedal, the engine will not start, and it will be displayed on the cluster as in the following pop-up.

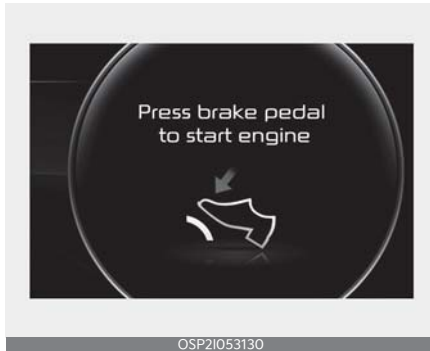

When the shift lever is not placed in N (Neutral), the following pop-up will be displayed on the cluster

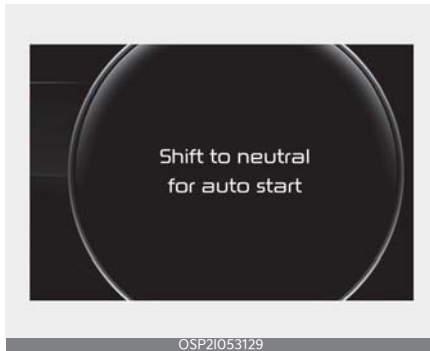

**Automatic transmission/Intelligent variable transmission** - Place the transmission shift lever in P (Park). Depress the brake pedal fully.

You can also start the engine when the shift lever is in the N (Neutral) position.

4. Press the ENGINE START/STOP button.

It should be started without depressing the accelerator pedal.

5. Do not wait for the engine to warm up whilst the vehicle remains stationary. Start driving at moderate engine speeds. (Steep accelerating and decelerating should be avoided.)

## Starting the diesel engine

To start the diesel engine when the engine is cold, it has to be pre-heated before starting the engine and then have to be warmed up before starting to drive.

1. Make sure the parking brake is applied.
2. **Manual Transmission** - Depress the clutch pedal fully and shift the transmission into Neutral. Keep the clutch pedal and brake pedal depressed whilst pressing the ENGINE START/STOP button to the START position.

### Intelligent Manual Transmission

**(iMT)** - Shift the transmission into Neutral. Keep the brake pedal depressed whilst pressing the ENGINE START/STOP button to the START position.

If you press the ENGINE START/STOP button to the START position without depressing the brake pedal, the engine will not start, and it will be displayed on the cluster as in the following pop-up.

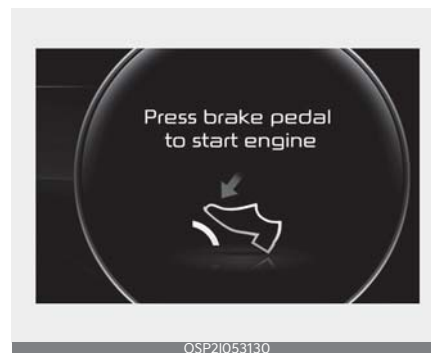

When the shift lever is not placed in N (Neutral), the following pop-up will be displayed on the cluster

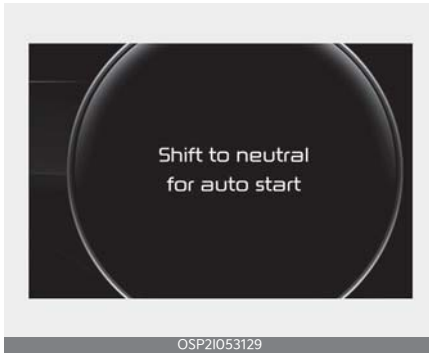

**Automatic Transmission** - Place the transmission shift lever in P (Park). Depress the brake pedal fully. You can also start the engine when the shift lever is in the N (Neutral) position.

Glow indicator light



3. Press the ENGINE START/STOP button whilst depressing the brake pedal.
4. Continue depressing the brake pedal until the illuminated glow indicator goes off. (approximately 5 seconds)
5. The engine starts running when the glow indicator goes off.

#### **⚠ CAUTION**

- Recommend to wait for the diesel engine to warm up whilst the vehicle remains stationary in winter for a whilst and drive.
- Recommend to use diesel fuel in a high altitude mountain or country where you visit in winter.

#### **\* NOTICE**

If the ENGINE START/STOP button is pressed once more whilst the engine is pre-heating, the engine may start.

#### **Starting and stopping the engine for turbocharger intercooler**

1. Do not race or accelerate the engine immediately after starting.  
If the engine is cold, idle for several seconds before sufficient lubrication is ensured in the turbocharger unit.
2. After high speed or extended driving, requiring a heavy engine load, idle the engine about 1 minute before turning it off.  
This idle time will allow the turbocharger to cool prior to shutting the engine off.

#### **⚠ CAUTION**

Do not turn the engine off immediately after it has been subjected to a heavy load. Doing so may cause severe damage to the engine or turbocharger unit.

5



## Stopping the petrol engine/diesel engine (Manual Transmission/ Intelligent Manual Transmission (iMT))

1. Make sure the vehicle is completely stopped and keep the clutch pedal (for manual transmission) and brake pedal depressed.
2. Shift the transmission into Neutral whilst depressing the clutch pedal (for manual transmission) and brake pedal.
3. Engage the parking brake whilst depressing the brake pedal.
4. Press the ENGINE START/STOP button to turn the engine off.

## Manual transmission (if equipped)

The manual transmission has 6 forward gears.

### Manual transmission operation

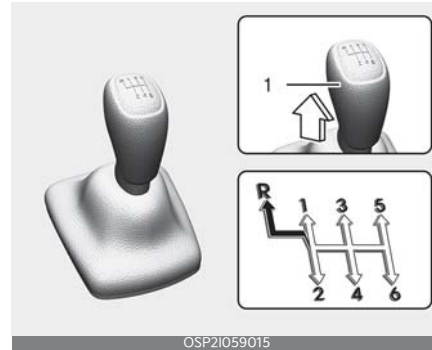

⇨ The shift lever can be moved without pulling the button (1).

➡ The button (1) should be pressed when moving the shift lever into reverse.

This shift pattern is imprinted on the shift knob. The transmission is fully synchronized in all forward gears so shifting to either a higher or a lower gear is easily accomplished.

Depress the clutch pedal down fully whilst shifting, then release it slowly.

If your vehicle is equipped with an ignition lock switch, the engine will not start when starting the engine without depressing the clutch pedal. (if equipped)

The shift lever must be returned to the neutral position before shifting into R (Reverse).

Push the button located immediately below the shift knob and pull the gear-shift lever to the left sufficiently, and then shift into reverse (R) gear position.

Make sure the vehicle is completely stopped before shifting into R (Reverse). Never operate the engine with the tachometer (rpm) in the red zone.

### ⚠ CAUTION

- When downshifting from fifth gear to fourth gear, caution should be taken not to inadvertently press the shift lever sideways in such a manner that the second gear is engaged. Such a drastic downshift may cause the engine speed to increase to the point that the tachometer will enter the red-zone. Such over-revving of the engine and transmission may possibly cause engine damage.
- Do not downshift more than 2 gears or downshift the gear when the engine is running at high speed (5,000 rpm or higher). Such a downshifting may damage the engine, clutch and the transmission.

- During cold weather, shifting may be difficult until the transmission lubricant is warmed up. This is normal and not harmful to the transmission.
- If you've come to a complete stop and it's hard to shift into 1st or R (Reverse), leave the shift lever at N (Neutral) position and release the clutch. Press the clutch pedal back down, and then shift into 1st or R (Reverse) gear position.

### ⚠ CAUTION

- To avoid premature clutch wear and damage, do not drive with your foot resting on the clutch pedal. Also, don't use the clutch to hold the vehicle stopped on an uphill grade, whilst waiting for a traffic light, etc.

- Do not use the shift lever as a handrest during driving, as this can result in premature wear of the transmission shift forks.
- To prevent possible damage to the clutch system, do not start with the 2nd (second) gear engaged except when you start on a slippery road.

### ⚠ WARNING

- Before leaving the driver's seat, always set the parking brake fully and shut the engine off. Then make sure the transmission is shifted into 1st gear when the vehicle is parked on a level or uphill grade, and shifted into R (Reverse) on a downhill grade. Unexpected and sudden vehicle movement can occur if these precautions are not followed in the order identified.
- Do not use the engine brake (shifting from a high gear to lower gear) rapidly on slippery roads. The vehicle may slip causing an accident.

### Using the clutch

The clutch should be pressed all the way to the floor before shifting, then released slowly. The clutch pedal should always be fully released whilst driving. Do not rest your foot on the clutch pedal whilst driving. This can cause unnecessary wear. Do not partially engage the clutch to hold the vehicle on an incline. This causes unnecessary wear. Use the foot brake or parking brake to hold the vehicle on an incline. Do not operate the clutch pedal rapidly and repeatedly.

### ⚠ CAUTION

When operating the clutch pedal, press the clutch pedal down fully. If you don't

press the clutch pedal fully, the clutch may be damaged or noise may occur.

### WARNING

#### Using the clutch

Depress the clutch pedal as far as possible. Be aware not to apply the pedal again before it returns to the normal position.

If the pedal is repeatedly depressed before returning to its normal position, the clutch system might be damaged.

Do not overload the vehicle. Starting or driving a vehicle in this situation generates too much frictional heat to the clutch disk which might cause damage to the clutch cover and disk.

When starting the vehicle or driving backwards, releasing the clutch pedal too soon after shifting the lever might turn off the engine and lead to an accident.

#### Downshifting

When you must slow down in heavy traffic or whilst driving up steep hills, downshift before the engine starts to labour. Downshifting reduces the chance of stalling and gives better acceleration when you again need to increase your speed. When the vehicle is travelling down steep hills, downshifting helps maintain safe speed and prolongs brake life.

#### Good driving practices

- Never take the vehicle out of gear and coast down a hill. This is extremely hazardous. Always leave the vehicle in gear.
- Don't "ride" the brakes. This can cause them to overheat and malfunction. Instead, when you are driving down a

long hill, shift to a lower gear. When you do this, engine braking will help slow down the vehicle.

- Slow down before shifting to a lower gear. This will help avoid over-revving the engine, which can cause damage.
- Slow down when you encounter cross winds. This gives you much better control of your vehicle.
- Be sure the vehicle is completely stopped before you attempt to shift into reverse. The transmission can be damaged if you do not.
- Exercise extreme caution when driving on a slippery surface. Be especially careful when braking, accelerating or shifting gears. On a slippery surface, an abrupt change in vehicle speed can cause the drive wheels to lose traction and the vehicle to go out of control.

### WARNING

- Always buckle-up! In a collision, an unbelted occupant is significantly more likely to be seriously injured or killed than a properly belted occupant.
- Avoid high speeds when cornering or turning.
- Do not make quick steering wheel movements, such as sharp lane changes or fast, sharp turns.
- The risk of rollover is greatly increased if you lose control of your vehicle at highway speeds.
- Loss of control often occurs if two or more wheels drop off the roadway and the driver oversteers to reenter the roadway.
- In the event your vehicle leaves the roadway, do not steer sharply.

Instead, slow down before pulling back into the travel lanes.

- Never exceed posted speed limits.

### Intelligent Manual transmission (if equipped)

Intelligent Manual Transmission (iMT) system use E-Clutch (Electronic Clutch) technology. Using the E-Clutch, the vehicle can cut engine drive off without pressing the clutch pedal by driver. The E-Clutch is controlled by an actuator that assists the driver in changing gear.

Intelligent Manual Transmission (iMT) technology improves driving convenience better than conventional Manual Transmission. There is NO CLUTCH PEDAL. The clutch is operated automatically, whilst shifting gear.

When the driver steps on the accelerator and tries to shift the gear, there could be a sense of obstruction compared to Manual Transmission.

To start engine, press the brake pedal and the shift lever at neutral position.

The driver can operate the vehicle on the flat ground when the gear is in first or second but the following warning message appears if the driver tries to operate when the gear is put in above third.

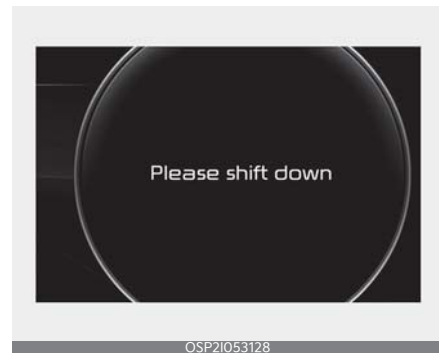

It is possible to drive on a slope with the gear is in first but the following warning message appears when the driver operates whilst the gear is in above second.





The following extreme cases may damage the clutch due to overheating whilst driving. Vehicle's own protection system sounds alarm and displays warning messages. Please shift into lower gear or stop the vehicle according to the instruction.

Shift into second gear and start to drive on a hill/drive at low speed. Stop the vehicle on a hill with the accelerator/ maintain low speed status. Repetitive sudden accelerations and repetitive starts on a hill.

### **CAUTION**

- Do not press the brake pedal by mistake during gear shift.
- The vehicle may not move or move jerkily, if proper gear is not selected according to the speed.

- Use the 1st gear and the parking brake to avoid roll-back during hill start.

## Intelligent Manual Transmission (iMT) operation

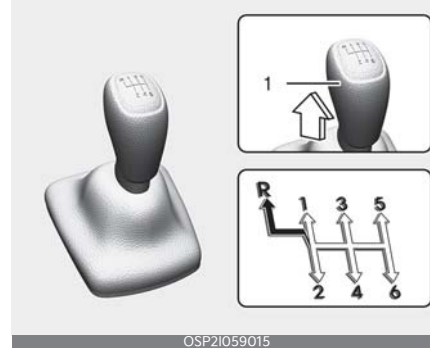

⇨ The shift lever can be moved without pulling the button (1).

➡ The button (1) should be pressed when moving the shift lever into reverse.

The Intelligent manual transmission (iMT) has 6 forward gears and 1 reverse gear.

This shift pattern is imprinted on the shift knob. The transmission is fully synchronized in all forward gears so shifting to either a higher or a lower gear is easily accomplished.

The shift lever must be returned to the neutral position before shifting into R (Reverse).

Push the button located immediately below the shift knob and pull the gear-shift lever to the left sufficiently, and then shift into reverse (R) gear position.

Make sure the vehicle is completely stopped before shifting into R (Reverse).

Never operate the engine with the tachometer (rpm) in the red zone.

**CAUTION**

- When downshifting from fifth gear to fourth gear, caution should be taken not to inadvertently press the shift lever sideways in such a manner that the second gear is engaged. Such a drastic downshift may cause the engine speed to increase to the point that the tachometer will enter the red-zone. Such overrevving of the engine and transmission may possibly cause engine damage.
- Do not downshift more than 2 gears or downshift the gear when the engine is running at high speed (5,000 rpm or higher). Such a downshifting may damage the engine, clutch and the transmission.
- During cold weather, shifting may be difficult until the transmission lubricant is warmed up. This is normal and not harmful to the transmission.
- If you've come to a complete stop and it's hard to shift into 1st or R (Reverse), leave the shift lever at N (Neutral) position and shift into 1st or R (Reverse) gear position.

**CAUTION**

- Do not use the shift lever as a handrest during driving, as this can result in premature wear of the transmission shift forks.
- To prevent possible damage to the clutch system, do not start with the 2nd (second) gear engaged except when you start on a slippery road.

**WARNING**

- Before leaving the driver's seat, always set the parking brake fully and shut the engine off. Then make sure

the transmission is shifted into 1st gear when the vehicle is parked on a level or uphill grade, and shifted into R (Reverse) on a downhill grade. Unexpected and sudden vehicle movement can occur if these precautions are not followed in the order identified.

- Do not use the engine brake (shifting from a high gear to lower gear) rapidly on slippery roads. The vehicle may slip causing an accident.

**Downshifting**

When you must slow down in heavy traffic or whilst driving up steep hills, downshift before the engine starts to labour. Downshifting reduces the chance of stalling and gives better acceleration when you again need to increase your speed. When the vehicle is travelling down steep hills, downshifting helps maintain safe speed and prolongs brake life.

**Transmission high temperature**

Refer to "Transmission overheated" on page 5-22 for details.

## Transmission overheated



Refer to "Transmission overheated" on page 5-22 for details.

### Good driving practices

- Never take the vehicle out of gear and coast down a hill. This is extremely

hazardous. Always leave the vehicle in gear.

- Don't "ride" the brakes. This can cause them to overheat and malfunction. Instead, when you are driving down a long hill, shift to a lower gear. When you do this, engine braking will help slow down the vehicle.
- Slow down before shifting to a lower gear. This will help avoid over-revving the engine, which can cause damage.
- Slow down when you encounter cross winds. This gives you much better control of your vehicle.
- Be sure the vehicle is completely stopped before you attempt to shift into reverse. The transmission can be damaged if you do not.
- Exercise extreme caution when driving on a slippery surface. Be especially careful when braking, accelerating or shifting gears. On a slippery surface, an abrupt change in vehicle speed can cause the drive wheels to lose traction and the vehicle to go out of control.

### **WARNING**

- When driving uphill or downhill, always shift to 1st gear for driving forward or shift to R (Reverse) for driving backwards, and check the gear position indicated on the cluster before driving. Driving in the opposite direction of the selected gear can lead to a dangerous situation by shutting off the engine and affecting the braking performance.
- Always buckle-up! In a collision, an unbelted occupant is significantly more likely to be seriously injured or killed than a properly belted occupant.

- Avoid high speeds when cornering or turning.
- Do not make quick steering wheel movements, such as sharp lane changes or fast, sharp turns.
- The risk of rollover is greatly increased if you lose control of your vehicle at highway speeds.
- Loss of control often occurs if two or more wheels drop off the roadway and the driver oversteers to reenter the roadway.
- In the event your vehicle leaves the roadway, do not steer sharply. Instead, slow down before pulling back into the travel lanes.
- Never exceed posted speed limits.

## Automatic transmission (if equipped)

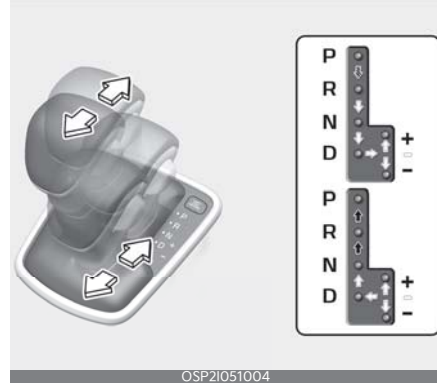

### Automatic transmission operation

The automatic transmission has 6 forward speeds and one reverse speed. The individual speeds are selected automatically, depending on the position of the shift lever.

#### \* NOTICE

The first few shifts on a new vehicle, if the battery has been disconnected, may be somewhat abrupt. This is a normal condition, and the shifting sequence will adjust after shifts are cycled a few times by the TCM (Transmission Control Module) or PCM (Powertrain Control Module).

For smooth operation, depress the brake pedal when shifting from N (Neutral) to a forward or reverse gear.

#### ⚠ WARNING

### Automatic transmission

- Always check the surrounding areas near your vehicle for people, especially children, before shifting a vehicle into D (Drive) or R (Reverse).



- Before leaving the driver's seat, always make sure the shift lever is in the P (Park) position; then set the parking brake fully and shut the engine off. Unexpected and sudden vehicle movement can occur if these precautions are not followed in the order identified.
- Do not use the engine brake (shifting from a high gear to lower gear) rapidly on slippery roads.  
The vehicle may slip causing an accident.

### **⚠ CAUTION**

- To avoid damage to your transmission, do not accelerate the engine in R (Reverse) or any forward gear position with the brakes on.
- When stopped on an incline, do not hold the vehicle stationary with engine power. Use the service brake or the parking brake.
- Do not shift from N (Neutral) or P (Park) into D (Drive), or R (Reverse) when the engine is above idle speed.

## Transmission ranges

The indicator in the instrument cluster displays the shift lever position when the ignition switch is in the ON position.

### P (Park)

Always come to a complete stop before shifting into P (Park). This position locks the transmission and prevents the front wheels from rotating.

### **⚠ WARNING**

- Shifting into P (Park) whilst the vehicle is in motion will cause the drive

wheels to lock which will cause you to lose control of the vehicle.

- Do not use the P (Park) position in place of the parking brake. Always make sure the shift lever is latched in the P (Park) position and set the parking brake fully.
- Never leave a child unattended in a vehicle.

### **⚠ CAUTION**

The transmission may be damaged if you shift into P (Park) whilst the vehicle is in motion.

### R (Reverse)

Use this position to drive the vehicle backward.

### **⚠ CAUTION**

Always come to a complete stop before shifting into or out of R (Reverse); you may damage the transmission if you shift into R whilst the vehicle is in motion, except as explained in "Rocking the vehicle" on page 5-67.

### N (Neutral)

The wheels and transmission are not engaged. The vehicle will roll freely even on the slightest incline unless the parking brake or service brakes are applied.

### **⚠ WARNING**

Do not drive with the shift lever in N (Neutral).

The engine brake will not work and lead to an accident.

### Parking in N (Neutral) gear

Follow below steps when parking and you want the vehicle to move when pushed.

1. After parking your vehicle, step on the brake pedal and move the shift lever to "P" with the ignition button in "ON" or whilst the engine is running.
2. If the parking brake is applied unlock the parking brake.
3. Whilst pressing the brake pedal, turn the ignition button "OFF".
  - For smart key equipped vehicles, the ignition switch can be moved to "OFF" only when the shift lever is in "P".
4. Change the gear shift lever to "N" (Neutral) whilst pressing the brake pedal and pushing "SHIFT LOCK RELEASE" button or inserting, pressing down a tool (e.g., flathead screwdriver) into the "SHIFT LOCK RELEASE" access hole at the same time. Then, the vehicle will move when external force is applied.

### ⚠ CAUTION

- With the exception of parking in neutral gear, always park the vehicle in "P" (Park) for safety and engage the parking brake.
- Before parking in "N" (Neutral) gear, first make sure the parking ground is level and flat. Do not park in "N" gear on any slopes or gradients.  
If parked and left in "N", the vehicle may move and cause serious damage and injury.

### D (Drive)

This is the normal forward driving position. The transmission will automatically

shift through a 6-gear sequence, providing the best fuel economy and power.

For extra power when passing another vehicle or climbing grades, depress the accelerator fully, at which time the transmission will automatically downshift to the next lower gear.

### \* NOTICE

Always come to a complete stop before shifting into D (Drive).

### Sports mode



5

Whether the vehicle is stationary or in motion, sports mode is selected by pushing the shift lever from the D (Drive) position into the manual gate. To return to D (Drive) range operation, push the shift lever back into the main gate.

In sports mode, moving the shift lever backwards and forwards will allow you to make gearshifts rapidly. In contrast to a manual transmission, the sports mode allows gearshifts with the accelerator pedal depressed.

- Up (+): Push the lever forward once to shift up one gear.
- Down (-): Pull the lever backwards once to shift down one gear.

### \* NOTICE

- In sports mode, the driver must execute upshifts in accordance with road conditions, taking care to keep the engine speed below the red zone.
- In sports mode, only the 6 forward gears can be selected. To reverse or park the vehicle, move the shift lever to the R (Reverse) or P (Park) position as required.
- In sports mode, downshifts are made automatically when the vehicle slows down. When the vehicle stops, 1st gear is automatically selected.
- In sports mode, when the engine rpm approaches the red zone shift points are varied to upshift automatically.
- To maintain the required levels of vehicle performance and safety, the system may not execute certain gearshifts when the shift lever is operated.
- When driving on a slippery road, push the shift lever forward into the +(up) position. This causes the transmission to shift into the 2nd gear which is better for smooth driving on a slippery road. Push the shift lever to the -(down) side to shift back to the 1st gear.

### Paddle shifter (if equipped)

The paddle shift function is available when the shift lever is in the D (Drive) position or the manual mode.

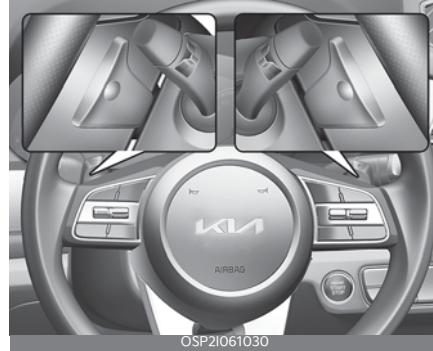

#### With the shift lever in the D position

The paddle shift function will operate when the vehicle speed is more than 10 km/h.

Pull the [+] or [-] paddle shifter once to shift up or down one gear and the system changes from automatic mode to manual mode.

When the vehicle speed is lower than 9 km/h, if you gently depress the accelerator pedal for more than 6 seconds or if you shift the shift lever from D (Drive) to manual mode and shift it from manual mode to D (Drive) again, the system changes, again, or pull the [+] paddle shifter for more than 1 second, the system changes from manual mode to automatic mode.

#### With the shift lever in the manual mode

Pull the [+] or [-] paddle shifter once to shift up or down one gear.

### \* NOTICE

If you pull the [+] and [-] paddle shifters at the same time, you cannot shift the gear.

### Shift lock system

For your safety, the automatic transmission has a shift lock system which prevents shifting the transmission from P (Park) into R (Reverse) unless the brake pedal is depressed.

To shift the transmission from P (Park) into R (Reverse):

1. Depress and hold the brake pedal.
2. Start the engine or turn the ignition switch to the ON position.
3. Move the shift lever.

If the brake pedal is repeatedly depressed and released with the shift lever in the P (Park) position, a chattering noise near the shift lever may be heard. This is a normal condition.

### ⚠ WARNING

Always fully depress the brake pedal before and whilst shifting out of the P (Park) position into another position to avoid inadvertent motion of the vehicle which could injure persons in or around the vehicle.

### Shift-lock override



If the shift lever cannot be moved from the P (Park) position into R (Reverse) position with the brake pedal depressed, continue depressing the brake, then do the following:

1. Place the ignition switch in the LOCK/OFF position.
2. Apply the parking brake.
3. Press the Shift Lock Release button.
4. Move the shift lever.

If the shift lever does not move even after performing this procedure, have the system inspected by a professional workshop. Kia recommends to visit an authorised Kia dealer/service partner.

5

## Ignition key interlock system (if equipped)

The ignition key cannot be removed unless the shift lever is in the P (Park) position.

### Good driving practices

- Never move the shift lever from P (Park) or N (Neutral) to any other position with the accelerator pedal depressed.
- Never move the shift lever into P (Park) when the vehicle is in motion.
- Be sure the vehicle is completely stopped before you attempt to shift into R (Reverse) or D (Drive).
- Never take the vehicle out of gear and coast down a hill. This may be extremely hazardous. Always leave the vehicle in gear when moving.
- Do not "ride" the brakes. This can cause them to overheat and malfunction. Instead, when you are driving down a long hill, slow down and shift to a lower gear. When you do this, engine braking will help slow down the vehicle.
- Slow down before shifting to a lower gear. Otherwise, the lower gear may not be engaged.
- Always use the parking brake. Do not depend on placing the transmission in P (Park) to keep the vehicle from moving.
- Exercise extreme caution when driving on a slippery surface. Be especially careful when braking, accelerating or shifting gears. On a slippery surface, an abrupt change in vehicle speed can cause the drive wheels to lose traction and the vehicle to go out of control.

- Optimum vehicle performance and economy is obtained by smoothly depressing and releasing the accelerator pedal.

### WARNING

- When driving uphill or downhill, always shift to D (Drive) for driving forward or shift to R (Reverse) for driving backwards, and check the gear position indicated on the cluster before driving.  
Driving in the opposite direction of the selected gear can lead to a dangerous situation by shutting off the engine and affecting the braking performance.
- Always buckle-up! In a collision, an unbelted occupant is significantly more likely to be seriously injured or killed than a properly belted occupant.
- Avoid high speeds when cornering or turning.
- Do not make quick steering wheel movements, such as sharp lane changes or fast, sharp turns.
- The risk of rollover is greatly increased if you lose control of your vehicle at highway speeds.
- Loss of control often occurs if two or more wheels drop off the roadway and the driver oversteers to reenter the roadway.
- In the event your vehicle leaves the roadway, do not steer sharply. Instead, slow down before pulling back into the travel lanes.
- Never exceed posted speed limits.

**⚠ WARNING**

If your vehicle becomes stuck in snow, mud, sand, etc., then you may attempt to rock the vehicle free by moving it forward and backward. Do not attempt this procedure if people or objects are anywhere near the vehicle. During the rocking operation the vehicle may suddenly move forward or backward as it becomes unstuck, causing injury or damage to nearby people or objects.

**Moving up a steep grade from a standing start**

To move up a steep grade from a standing start, depress the brake pedal, shift the shift lever to D (Drive). Select the appropriate gear depending on load weight and steepness of the grade, and release the parking brake. Depress the accelerator gradually whilst releasing the service brakes.

**When accelerating from a stop on a steep hill, the vehicle may have a tendency to roll backwards.**

**⚠ WARNING**

When you start driving after the car was stopped on a hill, even though the shift lever is in D (Driving) position, if you do not step on the accelerator pedal or brake pedal, the car may roll backward, resulting in a fatal accident.

Always come to a complete stop before shifting into D (Drive).

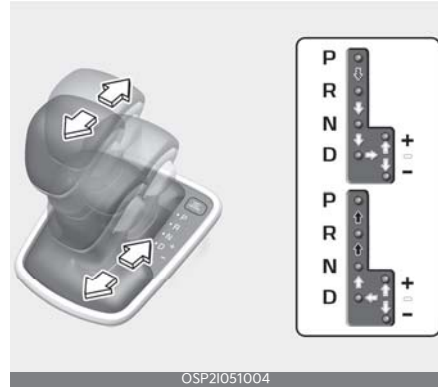
**Dual clutch transmission (if equipped)****Shift lever type**

Depress the brake pedal and the lock release button when shifting.

Press the unlock button when shifting.

The shift lever can be shifted freely.

- P (Park)
- R (Reverse)
- N (Neutral)
- D (Drive)

**Operation**

- Depress the brake pedal and shift the lever.

## Manual mode



### Operation

1. Push the shift lever from D (Drive) position into the manual gate.
  - Up (+): Push the lever forward once to shift up one gear.
  - Down (-): Pull the lever backwards once to shift down one gear.
2. Push the shift lever back into D (Drive) position to return to automatic mode.

### Shift lock

Shift lock prevents shifting from P (Park) into R (Reverse) unless the brake pedal is depressed.

### Operation

1. Depress and hold the brake pedal.
2. Turn the vehicle to the ON position.
3. Move the shift lever.

### \* INFORMATION

If the brake pedal is repeatedly depressed and released with the shift lever in the P (Park), a chattering noise near the shift lever may be heard. This is a normal condition.

## Overriding shift lock

If the shift lever cannot be moved from the P (Park) position into R (Reverse) position.



### Operation

1. Continue depressing the brake.
2. Turn the vehicle to the OFF position.
3. Make sure the parking brake is applied.
4. Carefully remove the shift knob boot.
5. Insert a tool (e.g. flathead screwdriver) into the access hole and press down on the tool.
6. Move the shift lever.
7. Remove the tool from the shift lock override access hole then install the knob boot.

Have the system checked by a professional workshop. Kia recommends to visit an authorised Kia dealer/service partner.

## Parking in N (Neutral) gear

Follow the steps below when the vehicle needs to be pushed whilst parking.

### Operation

1. Park your vehicle.
2. Depress the brake pedal.
3. Shift to P (Park) with the vehicle in ON position, or whilst the engine is running.
4. If the parking brake is applied, disengage the parking brake.
5. Whilst pressing the brake pedal, turn the ignition switch to OFF position.  
If equipped with smart key, the vehicle can be moved to OFF position only when the transmission is in P (Park).
6. Carefully remove the shift knob boot.
7. Insert a tool (e.g. flathead screwdriver) into the access hole and press down on the tool.
8. Move the shift lever to N (Neutral).
9. Remove the tool from the shift lock override access hole then install the knob boot.

Insert a screwdriver into the access hole and press down on the screwdriver.

### CAUTION

- With the exception of parking in neutral gear, always park the vehicle in P (Park) for safety and engage the parking brake.
- Before parking in N (Neutral), first make sure the parking ground is leveled and flat. Do not park in N (Neutral) on any slopes or gradients. If parked and left in N (Neutral), the vehicle may move and cause serious damage and injury.

## When the battery is discharged

### Operation

1. Connect the battery cables to the jump-starting terminals inside the engine compartment. For more details, refer to "Jump starting" on page 7-5.
2. Release the parking brake when the vehicle is in ON position.
3. Shift to N (Neutral).

### Characteristics of Dual clutch transmission

The dual clutch transmission has seven forward speeds and one reverse speed. The individual speeds are selected automatically when the shift lever is in the D (Drive) position.

- The dual clutch transmission can be thought of as an automatically shifting manual transmission. It gives the driving feel of a manual transmission, yet provides the ease of a fully automatic transmission.
- When D (Drive) is selected, the transmission will automatically shift through the gears similar to a conventional automatic transmission. Unlike a traditional automatic transmission, the gear shifting can sometimes be felt and heard as the actuators engage the clutches and the gears are selected.
- The dual clutch transmission incorporates a dry-type dual clutch mechanism, which allows for better acceleration performance and increased fuel efficiency whilst driving. But it differs from a conventional automatic transmission because it does not incorporate a torque converter. Instead, the transition from one



gear to the next is managed by clutch slip, especially at lower speeds.

As a result, shifts are sometimes more noticeable, and a light vibration can be felt as the transmission shaft speed is matched with the engine shaft speed. This is a normal condition of the dual clutch transmission.

- The dry-type clutch transfers torque more directly and provides a direct-drive feeling which may feel different from a conventional automatic transmission. This may be more noticeable when launching the vehicle from a stop or when travelling at low, stop-and-go vehicle speeds.
- When rapidly accelerating from a lower vehicle speed, the engine rpm may increase dramatically as a result of clutch slip as the dual clutch transmission selects the correct gear. This is a normal condition.
- When accelerating from a stop on an incline, press the accelerator smoothly and gradually to avoid any shudder feeling or jerkiness.
- When travelling at a lower vehicle speed, if you release the accelerator pedal quickly, you may feel engine braking before the transmission changes gears. This engine braking feeling is similar to operating a manual transmission at low speed.
- When driving downhill, you may wish to move the gear shift lever to Manual Shift mode and downshift to a lower gear in order to control your speed without using the brake pedal excessively.
- When you turn the engine on and off, you may hear clicking sounds as the system goes through a selftest. This is

a normal sound for the dual clutch transmission.

- During the first 1,500 km (1000 miles), you may feel that the vehicle may not be smooth when accelerating at low speed. During this break-in period, the shift quality and performance of your new vehicle is continuously optimized.

## DCT warning messages

This warning message is displayed when vehicle is driven slowly on a grade and the vehicle detects that the brake pedal is not applied.

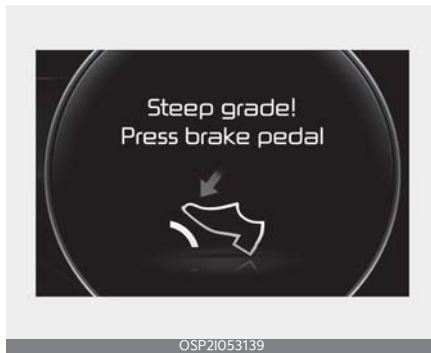

## Steep grade

Driving up hills or on steep grades:

- To hold the vehicle on an incline use the foot brake or the parking brake.
- If the vehicle is held on a hill by applying the accelerator pedal or by creeping with brake pedal disengaged, the clutch and transmission may overheat which can result in damage. At this time, a warning message will appear on the LCD display.
- If the LCD warning is active, the foot brake must be applied.
- Ignoring the warnings can lead to damage to the transmission.

## Transmission high temperature



- Under certain conditions, such as repeated stop-and-go launches on steep grades, sudden take off or acceleration, or other harsh driving conditions, the transmission clutch temperatures will increase excessively. Finally the clutch in transmission could be overheated.

### \* NOTICE

When driving in stop-and-go traffic, in stop condition, to reduce the driving stress and have better transmission operation move the shift lever to N (Neutral) or P (Parking) position.

- When the clutch is overheated, the safe protection mode engages and the gear position indicator on the cluster blinks with a chime. At this time, "Transmission temp. is high! Stop safely" warning message will appear on the LCD display and driving may not be smooth.
- If this occurs, pull over to a safe location, stop the vehicle with the engine running, apply the parking brake after shifting the vehicle to N (Neutral) with the brake pedal depressed, and allow the transmission to cool.

- If you ignore this warning, the driving condition may become worse. You may experience abrupt shifts, frequent shifts, or jerkiness. To return to the normal driving condition, stop the vehicle and apply the foot brake or shift into P (Park).

Then allow the transmission to cool for a few minutes with engine on, before driving off.

- When possible, drive the vehicle smoothly.

### Transmission overheated







- If the vehicle continues to be driven and the clutch temperatures reach the maximum temperature limit, the "Transmission hot! Park with engine On" warning will be displayed. When this occurs the clutch is disabled until the clutch cools to normal temperatures.
- The warning will display a time to wait for the transmission to cool.
- If this occurs, pull over to a safe location, stop the vehicle with the engine running, apply the brakes and shift the vehicle to P (Park), and allow the transmission to cool.
- When the message "Trans cooled. Resume driving." appears you can continue to drive your vehicle.
- When possible, drive the vehicle smoothly.

If any of the warning messages in the LCD display continue to blink, for your safety, Kia recommends to visit an authorised Kia dealer/service partner.

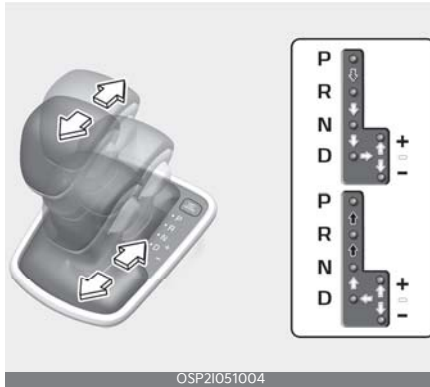
## Intelligent variable transmission (IVT) (if equipped)

The Intelligent Variable Transmission (IVT) automatically shifts depending on speed, accelerate pedal position. The individual speeds are selected automatically, depending on the position of the shift lever.



-  Depress the brake pedal and the lock release button when shifting.
-  Press the lock release button when shifting.
-  The shift lever can be shifted freely.

### Intelligent Variable Transmission (IVT) operation

For smooth operation, depress the brake pedal when shifting from N (Neutral) to a forward or reverse gear.

#### WARNING

#### Intelligent Variable Transmission (IVT)

- Always check the surrounding areas near your vehicle for people, especially children, before shifting a car into D (Drive) or R (Reverse).
- Before leaving the driver's seat, always make sure the shift lever is in

the P (Park) position; then set the parking brake fully and shut the engine off. Unexpected and sudden vehicle movement can occur if these precautions are not followed in the order identified.

- Do not use the engine brake (shifting from a high gear to lower gear) rapidly on slippery roads. The vehicle may slip causing an accident.

#### CAUTION

- To avoid damage to your transmission, do not accelerate the engine in R (Reverse) or any forward gear position with the brakes on.
- When stopped on an incline, do not hold the vehicle stationary with engine power. Use the service brake or the parking brake.
- Do not shift from N (Neutral) or P (Park) into D (Drive), or R (Reverse) when the engine is above idle speed.

### Transmission ranges

The indicator in the instrument cluster displays the shift lever position when the ignition switch is in the ON position.

#### P (Park)

Always come to a complete stop before shifting into P (Park). This position locks the transmission and prevents the front wheels from rotating.

#### WARNING

- Shifting into P (Park) whilst the vehicle is in motion will cause the drive wheels to lock which will cause you to lose control of the vehicle.

- Do not use the P (Park) position in place of the parking brake. Always make sure the shift lever is latched in the P (Park) position and set the parking brake fully.
- Never leave a child unattended in a vehicle.

### CAUTION

The transmission may be damaged if you shift into P (Park) whilst the vehicle is in motion.

### CAUTION

The RPM (revolution per minute) may increase or decrease when performing the Intelligent Variable Transmission (IVT) self-diagnosis.

## R (Reverse)

Use this position to drive the vehicle backward.

### CAUTION

Always come to a complete stop before shifting into or out of R (Reverse); you may damage the transmission if you shift into R whilst the vehicle is in motion, except as explained in "Rocking the vehicle" on page 5-67.

## N (Neutral)

The wheels and transmission are not engaged. The vehicle will roll freely even on the slightest incline unless the parking brake or service brakes are applied.

### WARNING

Do not drive with the shift lever in N (Neutral).

The engine brake will not work and lead to an accident.

## Parking in N (Neutral) gear

Follow below steps when parking and you want the vehicle to move when pushed.

1. After parking your vehicle, step on the brake pedal and move the shift lever to "P" with the ignition button in "ON" or whilst the engine is running.
2. If the parking brake is applied unlock the parking brake.
3. Whilst pressing the brake pedal, turn the ignition button "OFF".
  - For smart key equipped vehicles, the ignition switch can be moved to "OFF" only when the shift lever is in "P".
4. Change the gear shift lever to "N" (Neutral) whilst pressing the brake pedal and pushing "SHIFT LOCK RELEASE" button or inserting, pressing down a tool (e.g., flathead screwdriver) into the "SHIFT LOCK RELEASE" access hole at the same time. Then, the vehicle will move when external force is applied.

### CAUTION

- With the exception of parking in neutral gear, always park the vehicle in "P" (Park) for safety and engage the parking brake.
- Before parking in "N" (Neutral) gear, first make sure the parking ground is level and flat. Do not park in "N" gear on any slopes or gradients. If parked and left in "N", the vehicle may move and cause serious damage and injury.

## D (Drive)

This is the normal forward driving position. The transmission will automatically shift, providing the best fuel economy and power.

For extra power when passing another vehicle or climbing grades, depress the accelerator fully, at which time the transmission will automatically downshift to the next lower gear.

### \* NOTICE

Always come to a complete stop before shifting into D (Drive).

## Sports mode



Whether the vehicle is stationary or in motion, sports mode is selected by pushing the shift lever from the D (Drive) position into the manual gate. To return to D (Drive) range operation, push the shift lever back into the main gate.

SPORT mode manages the driving dynamics by automatically adjusting the steering effort, and the engine and transmission control logic for enhanced driver performance.

In sports mode, moving the shift lever backwards and forwards will allow you to make gearshifts rapidly. In contrast to

a manual transmission, the sports mode allows gearshifts with the accelerator pedal depressed.

- Up (+): Push the lever forward once to shift up one gear.
- Down (-): Pull the lever backwards once to shift down one gear.

### \* NOTICE

- In sports mode, the driver must execute upshifts in accordance with road conditions, taking care to keep the engine speed below the red zone.
- In sports mode, only the 8 forward gears can be selected. To reverse or park the vehicle, move the shift lever to the R (Reverse) or P (Park) position as required.
- In sports mode, downshifts are made automatically when the vehicle slows down. When the vehicle stops, 1st gear is automatically selected.
- In sports mode, when the engine rpm approaches the red zone shift points are varied to upshift automatically.
- To maintain the required levels of vehicle performance and safety, the system may not execute certain gearshifts when the shift lever is operated.
- When driving on a slippery road, push the shift lever forward into the + (up) position. This causes the transmission to shift into the 2nd gear which is better for smooth driving on a slippery road. Push the shift lever to the - (down) side to shift back to the 1st gear.
- When SPORT mode is activated:
  - The engine rpm will tend to remain raised over a certain length of time even after releasing the accelerator.

- Upshifts are delayed when accelerating.
- In SPORT mode, the fuel efficiency may decrease.

### Shift lock system (if equipped)

For your safety, the Intelligent Variable Transmission (IVT) has a shift lock system which prevents shifting the transmission from P (Park) into R (Reverse) unless the brake pedal is depressed.

To shift the transmission from P (Park) into R (Reverse):

1. Depress and hold the brake pedal.
2. Start the engine or turn the ignition switch to the ON position.
3. Move the shift lever.

If the brake pedal is repeatedly depressed and released with the shift lever in the P (Park) position, a chattering noise near the shift lever may be heard. This is a normal condition.

#### WARNING

Always fully depress the brake pedal before and whilst shifting out of the P (Park) position into another position to avoid inadvertent motion of the vehicle which could injure persons in or around the vehicle.

### Good driving practices

- Never move the shift lever from P (Park) or N (Neutral) to any other position with the accelerator pedal depressed.
- Never move the shift lever into P (Park) when the vehicle is in motion.
- Be sure the vehicle is completely stopped before you attempt to shift into R (Reverse) or D (Drive).

- Never take the vehicle out of gear and coast down a hill. This may be extremely hazardous. Always leave the vehicle in gear when moving.
- Do not "ride" the brakes. This can cause them to overheat and malfunction. Instead, when you are driving down a long hill, slow down and shift to a lower gear. When you do this, engine braking will help slow down the vehicle.
- Slow down before shifting to a lower gear. Otherwise, the lower gear may not be engaged.
- Always use the parking brake. Do not depend on placing the transmission in P (Park) to keep the vehicle from moving.
- Exercise extreme caution when driving on a slippery surface. Be especially careful when braking, accelerating or shifting gears. On a slippery surface, an abrupt change in vehicle speed can cause the drive wheels to lose traction and the vehicle to go out of control.
- Optimum vehicle performance and economy is obtained by smoothly depressing and releasing the accelerator pedal.

#### WARNING

- Always buckle-up! In a collision, an unbelted occupant is significantly more likely to be seriously injured or killed than a properly belted occupant.
- Avoid high speeds when cornering or turning.
- Do not make quick steering wheel movements, such as sharp lane changes or fast, sharp turns.

- The risk of a rollover is greatly increased if you lose control of your vehicle at highway speeds.
- Losing control often occurs if two or more wheels drop off the roadway and the driver oversteers to reenter the roadway.
- In the event your vehicle leaves the roadway, do not steer sharply. Instead, slow down before pulling back into the travel lanes.
- Never exceed posted speed limits.

### **▲ WARNING**

If your vehicle becomes stuck in snow, mud, sand, etc., then you may attempt to rock the vehicle free by moving it forward and backward. Do not attempt this procedure if people or objects are anywhere near the vehicle. During the rocking operation the vehicle may suddenly move forward or backward as it becomes unstuck, causing injury or damage to nearby people or objects.

### **Moving up a steep grade from a standing start**

To move up a steep grade from a standing start:

1. Depress the brake pedal, shift the shift lever to D (Drive).
2. Select the appropriate gear depending on load weight and steepness of the grade, and release the parking brake.
3. Depress the accelerator gradually whilst releasing the service brakes.

### **Brake system**

Your vehicle has power-assisted brakes, parking brake, and various braking systems for safe driving.

#### **Power brakes**

Your vehicle has power-assisted brakes that adjust automatically through normal usage.

In the event that the power-assisted brakes lose power because of a stalled engine or some other reason, you can still stop your vehicle by applying greater force to the brake pedal than you normally would. The stopping distance, however, will be longer.

When the engine is not running, the reserve brake power is partially depleted each time the brake pedal is applied. Do not pump the brake pedal when the power assist has been interrupted.

Pump the brake pedal only when necessary to maintain steering control on slippery surfaces.

### **\* NOTICE**

- When stepping on the brake pedal under a certain driving or weather condition you may witness your car make a sound of squealing or some other noises. This is not a brake malfunction but a normal phenomenon.
- When driving on the road to which deicing chemicals are applied, the vehicle may witness noises from the brake or abnormal abrasion of tyres because of such deicing chemicals. You should operate brake additionally so that you would be able to remove the deicing chemicals on the brake disk and pad under a safe traffic condition.



**⚠ CAUTION****Brake Pedal**

Do not drive with your foot resting on the brake pedal. This will create abnormally high brake temperatures which can cause excessive brake lining and pad wear.

**⚠ WARNING****Steep hill braking**

Avoid continuous application of the brakes when descending a long or steep hill by shifting to a lower gear. Continuous brake application will cause the brakes to overheat and could result in a temporary loss of braking performance.

Wet brakes may impair the vehicle's ability to safely slow down; the vehicle may also pull to one side when the brakes are applied. Applying the brakes lightly will indicate whether they have been affected in this way. Always test your brakes in this fashion after driving through deep water. To dry the brakes, apply them lightly whilst maintaining a safe forward speed until brake performance returns to normal.

**In the event of brake failure**

If service brakes fail to operate whilst the vehicle is in motion, you can make an emergency stop with the parking brake. The stopping distance, however, will be much greater than normal.

**⚠ WARNING****Parking brake**

Avoid applying the parking brake to stop the vehicle whilst it is moving except in an emergency situation. Applying the parking brake whilst the vehicle is moving at normal speeds can cause a sud-

den loss of control of the vehicle. If you must use the parking brake to stop the vehicle, use great caution in applying the brake.

**Brake Over Accelerator**

In the event the accelerator pedal becomes stuck or entrapped, apply steady and firm pressure to the brake pedal to slow the vehicle and reduce engine power.

If you experience this condition, take the following steps:

1. Apply the brakes and bring your vehicle to a safe stop.
2. Move the transmission to P (Park), switch the engine off and apply the parking brake.
3. Inspect the accelerator pedal for any interference.

If none are found and the condition persists, have your vehicle towed to an authorised Kia dealer and inspected.

**Disc brakes wear indicator**

When your brake pads are worn and new pads are required, you will hear a high-pitched warning sound from your front brakes or rear brakes. You may hear this sound come and go or it may occur whenever you press the brake pedal.

Please remember that some driving conditions or climates may cause a brake squeal when you first apply (or lightly apply) the brakes. This is normal and does not indicate a problem with your brakes.

Always replace the front or rear brake pads as pairs.

**⚠ CAUTION**

- To avoid costly brake repairs, do not continue to drive with worn brake pads.
- Always replace the front or rear brake pads as pairs.

**Rear drum brakes (if equipped)**

Your rear drum brakes do not have wear indicators. Therefore, have the rear brake linings inspected if you hear a rear brake rubbing noise. Also have your rear brakes inspected each time you change or rotate your tyres and when you have the front brakes replaced.

**⚠ CAUTION****Replace brake pads**

Do not continue to drive with worn brake pads. Continuing to drive with worn brake pads can damage the braking system and result in costly brake repairs.

**⚠ WARNING****Brake wear**

Do not ignore high pitched wear sounds from your brakes. If you ignore this audible warning, you will eventually lose braking performance, which could lead to a serious accident.

**\* NOTICE**

Brake dust may accumulate on the wheels, even under normal driving conditions. Some dust is inevitable as the brakes wear and does contribute to brake noise.

**Parking brake (if equipped)**

After parking the vehicle, apply the parking brake to prevent the vehicle from being moved by the external force.

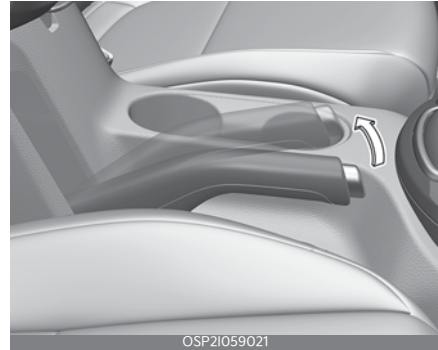
**Applying the parking brake**

OSP21059021

To engage the parking brake:

1. Apply the foot brake and then pull up the parking brake lever as far as possible.

In addition it is recommended that when parking the vehicle on a incline, the shift lever should be in a low gear on manual transmission vehicles.

**⚠ CAUTION**

- Driving with the parking brake applied will cause excessive brake pad and brake rotor wear.
- Do not operate the parking brake whilst the vehicle is moving except in an emergency situation. It could damage the vehicle system and make endanger driving safety.

5

## Releasing the parking brake

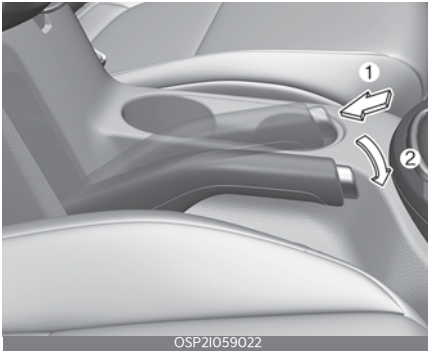

To release the parking brake:

1. Apply the foot brake and pull up the parking brake lever slightly.
2. Depress the release button (1) and lower the parking brake lever (2) whilst holding the button.

If the parking brake does not release or does not release all the way, have the system checked by a professional workshop. Kia recommends to visit an authorised Kia dealer/service partner.

- Be cautious when parking on a hill. Firmly engage the parking brake and place the shift lever in first or reverse gear (manual transmission). If your vehicle is facing downhill, turn the front wheels into the kerb to help keep the vehicle from rolling. If your vehicle is facing uphill, turn the front wheels away from the kerb to help keep the vehicle from rolling. If there is no kerb or if it is required by other conditions to keep the vehicle from rolling, block the wheels.
- Under some conditions your parking brake can freeze in the engaged position. This is most likely to happen when there is an accumulation of snow or ice around or near the rear brakes or if the brakes are wet. If

there is a risk that the parking brake may freeze, apply it only temporarily whilst you put the shift lever in first or reverse gear (manual transmission) and block the rear wheels so the vehicle cannot roll. Then release the parking brake.

- Do not hold the vehicle on the upgrade with the accelerator pedal. This can cause the transmission to overheat. Always use the brake pedal or parking brake.

### **⚠ WARNING**

- Never allow a passenger to touch the parking brake. If the parking brake is released unintentionally, serious injury may occur.
- All vehicles should always have the parking brake fully engaged when parking to avoid inadvertent movement of the vehicle which can injure occupants or pedestrians.



Check the brake warning light by turning the ignition switch ON (do not start the engine). This light will be illuminated when the parking brake is applied with the ignition switch in the START or ON position.

Before driving, be sure the parking brake is fully released and the brake warning light is off.

If the brake warning light remains on after the parking brake is released whilst engine is running, there may be a malfunction in the brake system. Immediate attention is necessary.

If at all possible, cease driving the vehicle immediately. If that is not possible, use extreme caution whilst operating the

vehicle and only continue to drive the vehicle until you can reach a safe location or repair shop.

## Electronic Parking Brake (EPB) (if equipped)

### Applying the parking brake

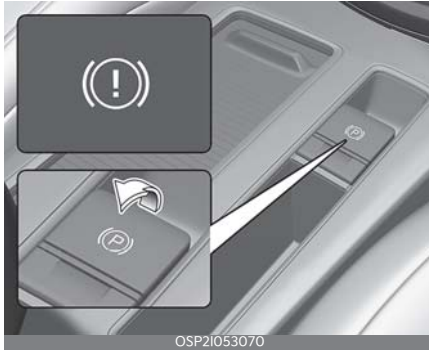

### To apply the EPB (electronic parking brake) manually:

1. Stop the vehicle.
2. Depress the brake pedal and pull up the EPB switch. Make sure the warning light comes on.

### EPB may be automatically applied when:

- Requested by other systems.
- If the driver applies the AUTO HOLD function whilst the engine is ON then turn the engine off, the EPB may be applied again automatically.

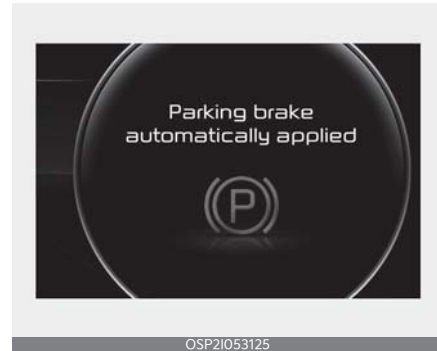

- If the driver turns the engine off by mistake whilst Auto Hold (if equipped) is operating, EPB will be automatically applied. But if the driver turns the engine off and push the EPB switch in 1 second, the EPB does not apply.

### Emergency braking

- If there is a problem with the brake pedal whilst driving, emergency braking is possible by pulling up and holding the EPB switch. Braking is possible only whilst you are holding the EPB switch. If you hand off the EPB switch, the braking force is lost. If you hold the EPB switch and the vehicle stop, the EPB is applied.
  - The braking distance may be longer than under normal braking conditions.
- \* EPB stands for Electronic Parking Brake.

### ⚠ WARNING

Do not operate the parking brake whilst the vehicle is moving except in an emergency situation. It could damage the vehicle system and endanger driving safety.

**CAUTION**

If you continuously notice a noise or burning smell when the EPB is used for emergency braking, have the system checked by a professional workshop. Kia recommends visiting an authorised Kia dealer/service partner.

**Releasing the parking brake**

OSP2052399R

**To release the EPB manually:**

Press the EPB switch in the following condition.

1. Have the ignition switch or ENGINE START/STOP button in the ON position.
2. Depress the brake pedal.  
Make sure the brake warning light goes off.

**To release EPB automatically (automatic transmission):**

1. Close the driver's door, engine bonnet and tailgate.
2. Fasten the driver's seat belt.
3. Start the engine.
4. If the shift lever is in P (Park), depress the brake pedal and shift out of P (Park) to R (Rear) or D (Drive), the EPB is released automatically. Make sure the brake warning light goes off.

5. If the shift lever is in N (Neutral), depress the brake pedal and shift out of N (Neutral) to R (Rear) or D (Drive), the EPB is released automatically. Make sure the brake warning light goes off.

- If you try to drive off depressing the accelerator pedal with the EPB applied, but doesn't release automatically, a warning will sound once and a message will appear.



OSP21053124

- If the driver's seat belt is not fastened, driver's door is opened, the engine bonnet is opened in D or the tailgate is opened in D or R, a warning will sound once and a message will appear.
- If there is a problem with the vehicle, a warning may sound once and a message may appear. If the above situation occurs, depress the brake pedal and release EPB by pressing the EPB switch.

**WARNING**

- Never allow anyone who is unfamiliar with the vehicle to touch the parking brake. If the parking brake is released unintentionally, serious injury may occur.

- Do not place any objects around the EPB switch. They could release the EPB switch.

### ⚠ CAUTION

- To prevent unintentional movement when stopped and leaving the vehicle, do not use the shift lever in place of the parking brake. Set the parking brake and make sure the shift lever is securely positioned in P (Park). Use wheel chokes if necessary.
- In winter or cold conditions, the EPB may freeze. Park the vehicle with the shift lever in P on the even and safe place without applying the EPB. And use wheel chokes.
- Do not drive your vehicle with the EPB applied. It may cause excessive wear of brake pad and brake rotor.
- A click sound may be heard whilst operating or releasing the EPB, but these conditions are normal and indicate that the EPB is functioning properly.
- When leaving your keys with a parking lot attendant or valet, make sure to inform him/her how to operate the EPB.
- When the battery is drained, the EPB does not apply or release. In this case, jump start your vehicle.

## Malfunction of EPB

Type A



Type B



If the EPB malfunction indicator remains on, it indicates that the EPB may have malfunctioned. If this occurs, have the system checked by a professional workshop. Kia recommends visiting an authorised Kia dealer/service partner.

The EPB malfunction indicator may illuminate when the ESC indicator comes on to indicate that the ESC is not working properly, but it does not indicate a malfunction of the EPB.

### ⚠ CAUTION

- The EPB warning light may illuminate if the EPB switch operates abnormally. Shut the engine off and turn it on

again after a few minutes. The warning light will go off and the EPB switch will operate normally. However, if the EPB warning light is still on, have the system checked by a professional workshop. Kia recommends to visit an authorised Kia dealer/service partner.

- If the parking brake warning light does not illuminate or blinks even though the EPB switch was pulled up, the EPB is not applied. If the parking brake warning light blinks when the EPB warning light is on, press the switch, then pull it up. Once more press it back to its original position and pull it back up. If the EPB warning does not go off, have the system checked by a professional workshop. Kia recommends to visit an authorised Kia dealer/service partner.

### AUTO HOLD (if equipped)

The Auto Hold is designed to maintain the vehicle in a standstill even though the brake pedal is not pressed after the driver brings the vehicle to a complete stop by pressing the brake pedal.

### Applying Auto Hold function

1. Press the brake pedal and start the vehicle.
2. Press the Auto Hold button. The white AUTO HOLD indicator will come on indicating the system is in standby.

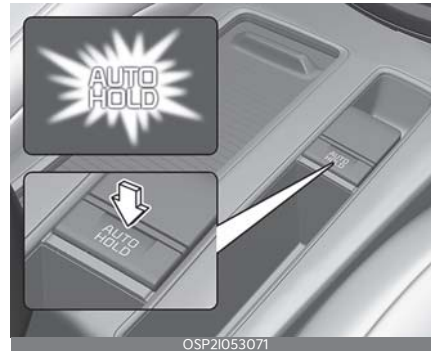

Before the Auto Hold will engage, the driver's door and engine bonnet must be closed and the tailgate must be closed.

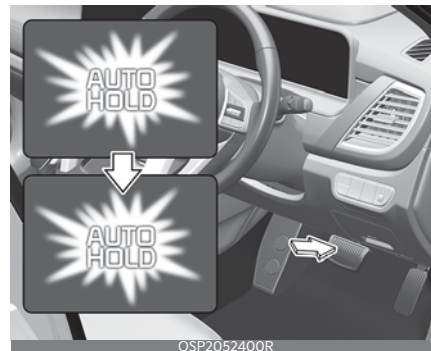

When coming to a complete stop by pressing the brake pedal, the AUTO HOLD indicator changes from white to green indicating the AUTO HOLD is engaged. The vehicle will remain at a standstill even if you release the brake pedal.

If EPB is applied, Auto Hold will be released.

If you press the accelerator pedal with the shift lever in D (Drive) or Manual mode, the Auto Hold will be released automatically and the vehicle will start to move. The indicator changes from green

to white indicating the Auto Hold is in standby and the EPB is released.

When driving off from Auto Hold by pressing the accelerator pedal, always check the surrounding area near your vehicle.

Slowly press the accelerator pedal for a smooth launch.

### Canceling Auto Hold function



- To cancel the Auto Hold operation, press the Auto Hold switch. The AUTO HOLD indicator will go out.
- To cancel the Auto Hold operation when the vehicle is at a standstill, press the Auto Hold switch whilst pressing the brake pedal.

#### \* NOTICE

- The following are conditions when the Auto Hold will not engage (Auto Hold light will not turn green and the Auto Hold system remains in stand by):
  - The driver's door is opened
  - The engine bonnet is opened
  - The shift lever is in P (Park) or R (Reverse)
  - The EPB is applied
- For your safety, the Auto Hold automatically switches to EPB under any of the following conditions (Auto Hold

light remains white and the EPB automatically applies):

- The driver's door is opened.
- The engine bonnet or tailgate is opened.
- The vehicle is in a standstill for more than 10 minutes.
- The vehicle is standing on a steep slope.
- The vehicle moved for a few seconds.

In these cases, the brake warning light comes on, the AUTO HOLD indicator changes from green to white, and a warning sounds and a message will appear to inform you that EPB has been automatically engaged. Before driving off again, press foot brake pedal, check the surrounding area near your vehicle and release parking brake manually with the EPB switch.

- If the AUTO HOLD indicator lights up yellow, the Auto Hold is not working properly. Take your vehicle to a professional workshop and have the system checked. Kia recommends to visit an authorised Kia dealer/service partner.

#### ⚠ WARNING

To reduce the risk of an accident, do not activate Auto Hold whilst driving downhill, backing up or parking your vehicle.

If there is a malfunction with the driver's door or engine bonnet or tailgate open detection system, the Auto Hold may not work properly.

Take your vehicle to a professional workshop and have the system checked.



Kia recommends to visit an authorised Kia dealer/service partner.

### \* NOTICE

A click or electric brake motor whine sound may be heard whilst operating or releasing the EPB, but these conditions are normal and indicate that the EPB is functioning properly.

### Warning messages

The Auto Hold function will display a warning message with sound under certain conditions.

When the EPB is applied from Auto Hold, a warning will sound and a message will appear.

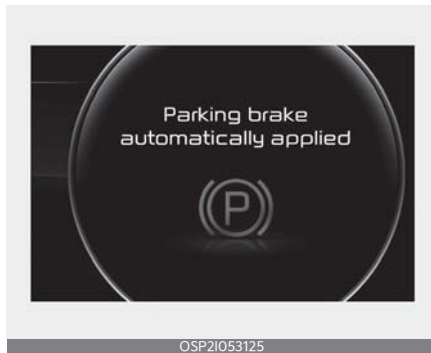

When the conversion from Auto Hold to EPB is not working properly a warning will sound and a message will appear.

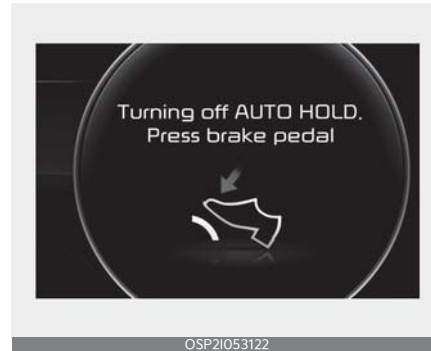

### \* NOTICE

When this message is displayed, the Auto Hold and EPB may not operate. For your safety, press the brake pedal.

If you do not apply the brake pedal when you release the Auto Hold by pressing the [AUTO HOLD] switch, a warning will sound and a message will appear.

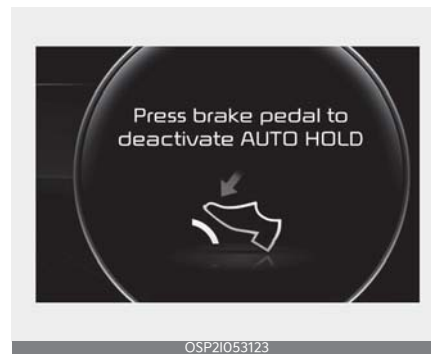

### Anti-lock Brake System (ABS)

The Anti-lock Brake System (ABS) prevents the wheels from locking. So the vehicle remains stable and can still be steered.

ABS (or ESC) will not prevent accidents due to improper or dangerous driving manoeuvres. Even though vehicle control is improved during emergency brak-

ing, always maintain a safe distance between you and objects ahead. Vehicle speeds should always be reduced during extreme road conditions. The vehicle should be driven at reduced speeds in the following circumstances:

- When driving on rough, gravel or snow-covered roads
- When driving with tyre chains installed
- When driving on roads where the road surface is pitted or has different surface heights.

Driving in these conditions increases the stopping distance for your vehicle.

The ABS continuously senses the speed of the wheels. If the wheels are going to lock, the ABS repeatedly modulates the hydraulic brake pressure to the wheels.

When you apply your brakes under conditions which may lock the wheels, you may hear a "tik-tik" sound from the brakes, or feel a corresponding sensation in the brake pedal. This is normal and it means your ABS is active.

In order to obtain the maximum benefit from your ABS in an emergency situation, do not attempt to modulate your brake pressure and do not try to pump your brakes. Press your brake pedal as hard as possible to allow the ABS to control the force being delivered to the brakes.

#### \* NOTICE

A click sound may be heard in the vehicle compartment when the vehicle begins to move after the vehicle is started. These conditions are normal and indicate that the Anti-lock Brake System is functioning properly.

Even with the Anti-lock Brake System, your vehicle still requires sufficient stopping distance. Always maintain a safe distance from the vehicle in front of you. Always slow down when cornering. The Anti-lock Brake System cannot prevent accidents resulting from excessive speeds.

On loose or uneven road surfaces, operation of the Anti-lock Brake System may result in a longer stopping distance than for vehicles equipped with a conventional brake system.

The ABS warning light will stay on for approximately 3 seconds after the ENGINE START/STOP button is ON.



5

During that time, the ABS will go through self diagnosis and the light will go off if everything is normal. If the light stays on, you may have a problem with your ABS. In this case, have the system checked by a professional workshop. Kia recommends to visit an authorised Kia dealer/service partner.

When you drive on a road having poor traction, such as an icy road, and have operated your brakes continuously, the ABS will be active continuously and the ABS warning light may illuminate. Pull your vehicle over to a safe place and stop the vehicle.

Restart the vehicle. If the ABS warning light goes off, then your ABS is normal. Otherwise, you may have a problem with the ABS. In this case, have the system checked by a professional workshop. Kia recommends to visit an authorised Kia dealer/service partner.

### \* NOTICE

When you jump start your vehicle because of a drained battery, the vehicle may not run as smoothly and the ABS warning light may turn on at the same time. This happens because of low battery voltage. It does not mean your ABS has malfunctioned.

- Do not pump your brakes!
- Have the battery recharged before driving the vehicle.

### Electronic Stability Control (ESC) system (if equipped)

The Electronic Stability Control (ESC) is designed to stabilize the vehicle during cornering manoeuvres.

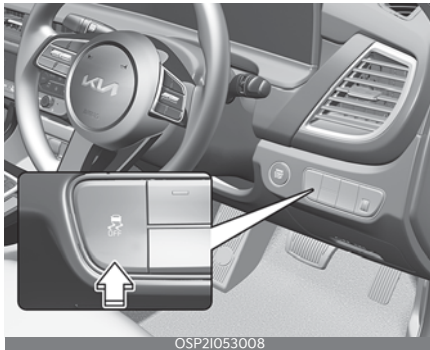

ESC applies the brakes on individual wheels and intervenes with the vehicle management system to stabilize the vehicle.

ESC will not prevent accidents. Excessive speed in turns, abrupt manoeuvres and hydroplaning on wet surfaces can still result in serious accidents.

Only a safe and attentive driver can prevent accidents by avoiding manoeuvres that cause the vehicle to lose traction. Even with ESC installed, always follow all the normal precautions for driving -

including driving at safe speeds for the conditions.

### ▲ WARNING

Never drive too fast for the road conditions or too quickly when cornering. Electronic stability Control (ESC) will not prevent accidents. Excessive speed in turns, abrupt manoeuvres and hydroplaning on wet surfaces can still result in serious accidents. Only a safe and attentive driver can prevent accidents by avoiding manoeuvres that cause the vehicle to lose traction. Even with ESC installed, always follow all the normal precautions for driving - including driving at safe speeds for the conditions.

The ESC system is an electronic system designed to help the driver maintain vehicle control under adverse conditions. It is not a substitute for safe driving practices. Factors including speed, road conditions and driver steering input can all affect whether ESC will be effective in preventing a loss of control. It is still your responsibility to drive and corner at reasonable speeds and to leave a sufficient margin of safety.

When you apply your brakes under conditions which may lock the wheels, you may hear a "tik-tik" sound from the brakes, or feel a corresponding sensation in the brake pedal. This is normal and it means your ESC is active.

### \* NOTICE

A click sound may be heard in the vehicle compartment when the vehicle begins to move after the vehicle is started. These conditions are normal and indicate that the Electronic Stability Control system is functioning properly.

## ESC operation

### ESC ON condition

- When the ENGINE START/STOP button is turned ON, ESC and ESC OFF indicator lights illuminate for approximately 3 seconds, then ESC is turned on.
- Press the ESC OFF button for at least half a second after turning the vehicle ON to turn ESC off. (ESC OFF indicator will illuminate). To turn the ESC on, press the ESC OFF button (ESC OFF indicator light will go off).
- When starting the vehicle, you may hear a slight ticking sound. This is the ESC performing an automatic system self-check and does not indicate a problem.

### When operating



When the ESC is in operation, the ESC indicator light blinks.

When the Electronic Stability Control is operating properly, you can feel a slight pulsation in the vehicle. This is only the effect of brake control and indicates nothing unusual.

When moving out of the mud or driving on a slippery road, pressing the accelerator pedal may not cause the vehicle rpm (revolutions per minute) to increase.

### ESC operation off





This car has 2 kinds of ESC off states.

If the vehicle stops when ESC is off, ESC remains off. Upon restarting the vehicle, the ESC will automatically turn on again.





### ESC off state 1

To turn off the traction control function and only operate the brake control function of the ESC, press the ESC OFF button (ESC OFF ) for less than 3 seconds and the ESC OFF indicator light (ESC OFF ) will illuminate.



### ESC off state 2

To turn off the traction control function and the brake control function of the ESC, press the ESC OFF button (ESC OFF ) for more than 3 seconds. ESC OFF indicator light (ESC OFF ) will illuminate and ESC OFF warning chime

will sound. At this state, the car stability control function does not operate any more.

## Indicator light

ESC indicator light



ESC OFF indicator light



When the ENGINE START/STOP button is turned to ON, the indicator light illuminates, then goes off if the ESC system is operating normally.

The ESC indicator light blinks whenever ESC is operating or illuminates when ESC fails to operate.

The ESC OFF indicator light comes on when the ESC is turned off with the button.

### **WARNING**

#### **Electronic Stability Control**

Drive carefully even though your vehicle has Electronic Stability Control. It can only assist you in maintaining control under certain circumstances.

## ESC OFF usage

### When driving

- ESC should be turned on for daily driving whenever possible.
- To turn ESC off whilst driving, press the ESC OFF button whilst driving on a flat road surface.

### **WARNING**

#### **Operating ESC**

Never press the ESC OFF button whilst ESC is operating (ESC indicator light blinks).

If ESC is turned off whilst ESC is operating, the vehicle may slip out of control.

### \* NOTICE

- When operating the vehicle on a dynamometer, ensure that the ESC is turned off (ESC OFF light illuminated). If the ESC is left on, it may prevent the vehicle speed from increasing, and result in false diagnosis.
- Turning the ESC off does not affect ABS or brake system operation.

## Vehicle Stability Management (VSM) system

The Vehicle Stability Management (VSM) provides further enhancements to vehicle stability and steering responses under the following condition:

- When driving on a slippery road or
- When a change in the coefficient of friction between left and right wheels is detected.

### ⚠ WARNING

#### Tyre/Wheel size

When replacing tyres and wheels, make sure they are the same size as the original tyres and wheels installed. Driving with varying tyre or wheel sizes may diminish any supplemental safety benefits of the VSM system.

## VSM operation

When the VSM is in operation, ESC indicator light () blinks.

When the VSM is operating properly, you can feel a slight pulsation in the vehicle and/or abnormal steering responses (MDPS (Motor Driven Power

Steering)). This is only the effect of brake and MDPS control and indicates nothing unusual.

## The VSM does not operate when:

- Driving on a sloping road such as a gradient or incline
- Driving in reverse
- ESC OFF indicator light () remains on the instrument cluster
- MDPS indicator light remains on the instrument cluster

## VSM operation off

If you press the ESC OFF button to turn off the ESC, the VSM will also cancel and the ESC OFF indicator light () illuminates.



To turn on the VSM, press the button again. The ESC OFF indicator light goes out.

### ⚠ WARNING

#### Vehicle Stability Management

Drive carefully even though your vehicle has Vehicle Stability Management. It can only assist you in maintaining control of the vehicle under certain circumstances.

## Malfunction indicator

The VSM can be deactivated even if you don't cancel the VSM operation by pressing the ESC OFF button. It indicates that a malfunction has been detected somewhere in the Electric Power Steering system or VSM system. If the ESC indicator light () or MDPS warning light () remains on, take your vehicle

to an authorised Kia dealer and have the system checked.

The VSM is not a substitute for safe driving practices but a supplementary function only. It is the responsibility of the driver to always check the speed and the distance to the vehicle ahead. Always hold the steering wheel firmly whilst driving.

Your vehicle is designed to activate according to the driver's intention, even with installed VSM. Always follow all the normal precautions for driving at safe speeds for the conditions - including driving in clement weather and on a slippery road.

#### **⚠ WARNING**

For maximum protection, always wear your seat belt. No system, no matter how advanced, can compensate for all driver error and/or driving conditions. Always drive responsibly.

### **Hill-start Assist Control (HAC) (if equipped)**

A vehicle has the tendency to roll back on a steep hill when it starts to go after stopping. The Hill-start Assist Control (HAC) prevents the vehicle from rolling back by applying the brakes automatically for about 2 seconds.

The brakes are released when the accelerator pedal is engaged or after about 2 seconds.

The HAC is activated only for about 2 seconds, so when the vehicle is starting off always engaged the accelerator pedal.

#### **⚠ WARNING**

### **Maintaining Brake Pressure on Incline**

HAC does not replace the need to apply brakes whilst stopped on an incline. Whilst stopped, make sure you maintain brake pressure sufficient to prevent your vehicle from rolling backward and causing an accident. Don't release the brake pedal until you are ready to accelerate forward.

### **Emergency Stop Signal (ESS)**

The Emergency Stop Signal system alerts the driver behind by blinking the stop light when the vehicle is braked rapidly and severely. The system is activated when:

- The vehicle suddenly stops (vehicle speed is over 55 km/h and the vehicle deceleration at greater than 7 m/s<sup>2</sup>)
- The ABS is activating

When the vehicle speed is under 40 km/h and the ABS deactivates or the sudden stop situation is over, the stop light blinking will stop. Instead, the hazard warning flasher will turn on automatically. The hazard warning flasher will turn off when vehicle speed is over 10 km/h after the vehicle has stopped. Also, it will turn off when the vehicle is driven at low speed for some time. You can turn it off manually by pushing the hazard warning flasher switch.

#### **⚠ CAUTION**

The Emergency Stop Signal (ESS) system will not work if the hazard warning flasher is already on.

## Brake Assistant System (BAS) (if equipped)

The Brake Assistant System provides additional pressure when the brake pedal is momentarily and strongly depressed in a situation sudden braking is required whilst driving.

The Brake Assistant System reduces the time for ABS (Anti-Lock Brake System) control to enter and consequently reduces the braking distance, by providing additional pressure up to the point of ABS intervention.

### BAS operation

- When the vehicle speed is more than 30 km/h and the ABS control is not entered.
- When the brake pedal is depressed strongly over a certain level.
- When the friction of the road surface is above a certain level.

### BAS operation off

- The vehicle speed is below 10 km/h.
- The brake pedal is depressed over a certain conditions.
- The friction of the road surface is below a certain level.

### WARNING

The system may not operate depending on driver's driving habit, the degree to which the brake pedal is depressed and the road surface condition.

## Good braking practices

Good braking practices help keep occupants safe and extend brake life.

- Check to be sure the parking brake is not engaged and the parking brake indicator light is out before driving away.
- Driving through water may get the brakes wet. They can also get wet when the vehicle is washed. Wet brakes can be dangerous! Your vehicle will not stop as quickly if the brakes are wet. Wet brakes may cause the vehicle to pull to one side. To dry the brakes, apply the brakes lightly until the braking action returns to normal, taking care to keep the vehicle under control at all times. If the braking action does not return to normal, stop as soon as it is safe to do so and call an authorised Kia dealer for assistance.
- Don't coast down hills with the vehicle out of gear. This is extremely hazardous. Keep the vehicle in gear at all times, use the brakes to slow down, then shift to a lower gear so that vehicle braking will help you maintain a safe speed.
- Don't "ride" the brake pedal. Resting your foot on the brake pedal whilst driving can be dangerous because the brakes might overheat and lose their effectiveness. It also increases the wear of the brake components.
- If a tyre goes flat whilst you are driving, apply the brakes gently and keep the vehicle pointed straight ahead whilst you slow down. When you are moving slowly enough for it to be safe to do so, pull off the road and stop in a safe place.



- Be cautious when parking on a hill. Firmly engage the parking brake and place the shifter dial in P. If your vehicle is facing downhill, turn the front wheels into the kerb to help keep the vehicle from rolling.  
If your vehicle is facing uphill, turn the front wheels away from the kerb to help keep the vehicle from rolling. If there is no kerb or if it is required by other conditions to keep the vehicle from rolling, block the wheels.
- Under some conditions your parking brake can freeze in the engaged position. This is most likely to happen when there is an accumulation of snow or ice around or near the rear brakes or if the brakes are wet. If there is a risk that the parking brake may freeze, apply it only temporarily whilst you put the shifter dial in P and block the rear wheels so the vehicle cannot roll. Then release the parking brake.
- Do not hold the vehicle on an incline with the accelerator pedal. This can cause the transmission to overheat. Always use the brake pedal or parking brake.

## Idle Stop and Go (ISG) system (if equipped)

Your vehicle may be equipped with the ISG system, which reduces fuel consumption by stopping and restarting the engine automatically.

The engine restarts as soon as the starting conditions are met.

- Manual Transmission
  - AUTO STOP

When the vehicle is slowed down to a speed below 5 km/h or temporarily stopped at a red light or brought to a standstill, release the clutch pedal in N (Neutral) position and the engine will shut down automatically.



- AUTO START

When the vehicle needs to move forward, press the clutch pedal and shift the gear. The engine will automatically turn on again.



- Automatic Transmission/Intelligent Manual Transmission/Intelligent Variable Transmission/Dual Clutch Transmission
    - AUTO STOP
- When the vehicle is temporarily stopped at a red light or brought to a standstill, depress the brake pedal

and the engine will turn off automatically.

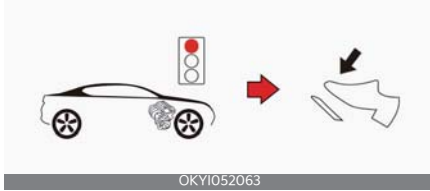

**- AUTO START**

When the vehicle needs to move forward, release the brake pedal and the engine will automatically turn on again.



**\* NOTICE**

When restarts engine by the ISG system, some warning lights (ABS, ESC, ESC OFF, EPS or Parking brake warning light) may turn on for a few seconds. This happens because of low battery voltage. It does not mean the system is malfunctioning.

**Activating the ISG**

The ISG system turns on whenever you switch the ignition on.

**Deactivating the ISG**

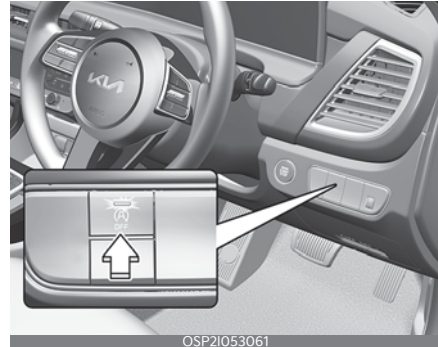

If you want to deactivate the ISG system, press the ISG OFF button. The light on the ISG OFF button will illuminate. If you press the ISG OFF button again, the system will be activated and the light on the ISG OFF button will turn off.



5

**Auto stop**

**To stop the engine in idle stop mode**

**Manual Transmission**

- Decrease the vehicle speed to less than 5 km/h (3 mph).
- Shift into N (Neutral) position.
- Release the clutch pedal.

**Automatic Transmission/Intelligent Manual Transmission/Intelligent Variable Transmission/Dual Clutch Transmission**

- Decrease the vehicle speed to 0 km/h (0 mph).
- Press the brake pedal.

The engine will stop and the AUTO STOP indicator (A) on the instrument cluster will be green.

#### \* NOTICE

If you unfasten the seat belt or open the driver's door (engine bonnet), ISG system will be deactivated.

### Auto start

#### To restart the engine from idle stop mode

#### Manual Transmission

Press the clutch pedal when the shift lever is in the N (Neutral) position.

#### \* NOTICE

After the vehicle has stalled, the engine starts if you operate as shown below:

1. Release the clutch pedal after the engine is completely stopped.
2. Depress the clutch pedal.

#### Automatic Transmission/Intelligent Manual Transmission/Intelligent Variable Transmission/Dual Clutch Transmission

In case Auto Hold is not activated:

- Release the brake pedal.

The engine will start and the AUTO STOP indicator (A) on the instrument cluster will be white.

- In case Auto Hold is activated:
  - Release the brake pedal and press the accelerator pedal in the D (Drive) position. The engine will restart and the AUTO STOP indica-

tor (A) on the instrument cluster will be white.

#### Operating conditions of ISG system

The ISG system will operate under following conditions:

- The driver's seatbelt is fastened.
- The driver's door and bonnet are closed.
- The brake vacuum pressure is adequate.
- The battery sensor is activated and the battery is sufficiently charged.
- Outside temperature is not too low or too high.
- The climate control system satisfies the conditions.
- The vehicle is sufficiently warmed up.
- The vehicle is not on a steep road grade. (except Manual Transmission)
- The steering wheel is not at a sharp angle. (except Manual Transmission)
- The vehicle is not at a high elevation.
- The front windscreen defroster is off.
- You have not selected Manual shift mode.
- Certain amount of time passed after releasing the gear from R (Reverse) position.

The engine will also restart automatically if the following occurs:

- The brake vacuum pressure is low.
- The engine is stopped for about 5 minutes.
- Fogging of the windows could occur and the air conditioning is on.
- The battery is not within optimal operating.
- The cooling and heating performance of the climate control system is unsatisfactory.
- When you press the ISG OFF button with the engine automatically

stopped. (except Manual Transmission)

- Your vehicle is moving after standstill.
- You press the accelerator and the brake pedal at the same time. (except Manual Transmission)
- The driver safety belt becomes unfastened or the driver door is ajar. (except Manual Transmission)
- The vehicle is shifted to P (Park) when Auto Hold is activated.
- The door is opened or the seatbelt is unfastened when Auto Hold is activated.
- The EPB switch is pressed when Auto Hold is activated.

The AUTO STOP indicator (A) on the instrument cluster will blink for 5 seconds.

**\* NOTICE**  
If the ISG system does not meet the operating conditions, the ISG system will be deactivated.

**ISG system indicator**



ISG system is indicated by the green AUTO STOP indicator (A) on the instrument cluster. The AUTO STOP display shows the warning message. (if equipped)

**LCD warning message**

**Manual Transmission**



The system may require the engine to manually restart for some reason. At this time, restart the vehicle manually by depressing the clutch with the gear in neutral.

**Automatic Transmission/Intelligent Manual Transmission/Intelligent Variable Transmission/Dual Clutch Transmission**

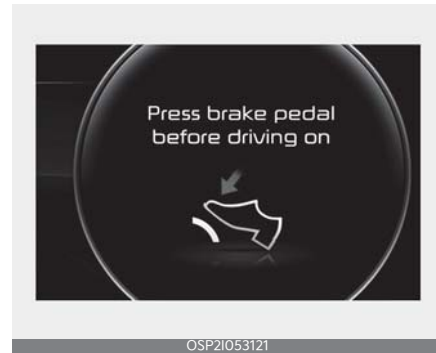

When the shift lever is shifted from N (Neutral) to R (Reverse), D (Drive) or Manual shift mode without the brake pedal depressed, a message will appear on the LCD display. To activate auto start, depress the brake pedal.



## ISG malfunction



The system may not operate when:

- The ISG related sensors or system error occurs.

The yellow AUTO STOP indicator (A) on the instrument cluster will stay on.

### ⚠ WARNING

When the engine is in Idle Stop mode, it's possible to restart the engine without the driver taking any action. Before leaving the car or doing anything in the engine room compartment, stop the engine by turning the ignition switch or ENGINE START/STOP button to the LOCK/OFF position or removing the ignition key.

### \* NOTICE

- If the ISG system continuously does not work correctly, have your vehicle inspected by a professional workshop as soon as possible. Kia recommends to contact an authorised Kia dealer/service partner.
- When the ISG OFF button light comes on, it may stop illuminating after driving your vehicle at approximately 80 km/h for a maximum of two hours and setting the fan speed control

below the 2nd position. If the ISG OFF button light blink continuously in spite of the procedure, have your vehicle inspected by a professional workshop as soon as possible. Kia recommends to contact an authorised Kia dealer/service partner.

- If the AGM battery is reconnected or replaced, ISG system will not operate immediately. If you want to use the ISG system, the battery sensor needs to be calibrated for approximately 4 hours with the ignition off. Before calibration, turn the ignition on and off 2 or 3 times.

## To help understand the ISG

- **Q.** What is ISG? And what is the function of it?  
**A.** ISG is an abbreviation of Idle Stop and Go. The feature contributes to protecting the environment and improving fuel economy by automatically shutting down the engine when a vehicle comes to a stop.
- **Q.** How does the ISG work?  
**A.** In the case of AT/IVT/iMT/DCT if a driver presses the brake to stop the vehicle, the engine is automatically shut off; if the driver releases the brake, the engine will restart. For MT, if a driver releases the clutch pedal in the N (Neutral) position, the engine is shut down; if the driver steps on the clutch pedal the engine will automatically restart. The ISG is operated only when the seat belt is fastened. The driver doesn't need to use the key or press the ENGINE START/STOP button for restarting.
- **Q.** Does the ISG work every time?  
**A.** No, it doesn't. The vehicle selectively operates ISG considering all

safety matters. It does not function when the vehicle is driving on steep hills (not applied to MT), and the vehicle requires air conditioning/heating or battery protection. For additional information on the safety conditions, please refer to the Owner's manual.

- **Q.** How can I deactivate the ISG feature?  
**A.** You can just press a button "ISG Off". Note that the ISG feature is reactivated if you start the engine using your key or the ENGINE START/STOP button.
- **Q.** The engine restarted even if I didn't operate any of it. Why did it happen?  
**A.** If required, the feature automatically starts the engine after monitoring the vehicle conditions including the battery and the air conditioning system.
- **Q.** Does the air conditioning work if the engine is shut down by ISG?  
**A.** No, it doesn't. In that case, the vehicle operates only the blower. If the vehicle's interior temperature is too warm, the engine will restart to operate the air conditioning.
- **Q.** Can the frequent use of ISG lead to undermining the durability of vehicle components?  
**A.** Not at all. We have enhanced the durability and performance of parts - such as a starting motor (starter), batteries and others- required for ISG. Also, for your safety, we applied safety logic to the system.

## Drive mode integrated control system

The drive mode may be selected according to the driver's preference or road condition.

The Drive mode will be changed as you turn the knob.

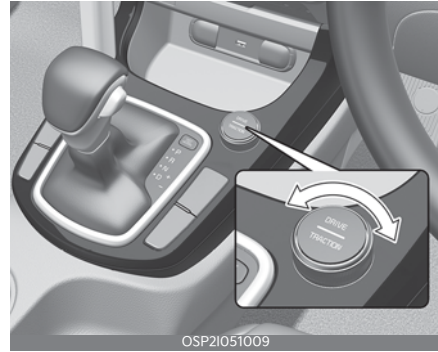

OSP21051009



OSP21053076

1. **NORMAL mode:** NORMAL mode provides soft driving and comfortable riding.
2. **ECO mode:** ECO mode improves fuel efficiency for eco-friendly driving.
3. **SPORT mode:** SPORT mode provides sporty but firm riding.

The driving mode will be set to NORMAL or ECO mode when the engine is restarted. If it is in NORMAL/SPORT mode, NORMAL mode will be set, when the engine is restarted.

If it is in ECO mode, ECO mode will be set when the engine is restarted.

### ECO mode

#### ECO

When the Drive Mode is set to ECO mode, the engine and transmission control logic are changed to maximize fuel efficiency.

- When ECO mode is selected by turning the Drive mode knob, the ECO indicator will illuminate.
- If the vehicle is set to ECO mode, when the engine is turned OFF and restarted the Drive Mode setting will remain in ECO mode.

#### \* NOTICE

Fuel efficiency depends on the driver's driving habit and road condition.

#### When ECO mode is activated:

- The acceleration response may be slightly reduced if the accelerator pedal is engaged moderately.
- The shift pattern of the automatic transmission may change.

The above situations are normal conditions when ECO mode is activated to improve fuel efficiency.

#### Limitation of ECO mode operation:

If the following conditions occur whilst ECO mode is operating, the system operation is limited even though there is no change in the ECO indicator.

- When driving the vehicle with the Automatic/IVT transmission gear shift lever in sport mode.

The system will be limited according to the shift location.

### SPORT mode

#### SPORT

SPORT mode manages the driving dynamics by automatically adjusting the steering effort, and the engine and transmission control logic for enhanced driver performance.

- When SPORT mode is selected by turning the knob, the SPORT indicator will illuminate.
- Whenever the engine is restarted, the Drive Mode will revert back to NORMAL mode. If SPORT mode is desired, re-select SPORT mode from the knob.
- When SPORT mode is activated:
  - The engine RPM will tend to remain high over a certain period of time even after releasing the accelerator.
  - Upshifts are delayed when accelerating.

#### \* NOTICE

In SPORT mode, the fuel efficiency may decrease.

### Traction control (if equipped)

Traction Control is a system that achieve optimal driving performance by controlling engine and braking by road condition (snow, muddy, sandy)

## Traction control mode



If you press the "DRIVE/TRACTION" mode button, the driving mode is changed from Driving control to Traction control. You can select SNOW (1), MUD (2) or SAND (3) mode by rotation the knob. If you press the "DRIVE/TRACTION" mode button again, the driving mode is changed from Traction Control to previous driving control.

The driving mode will be set to Driving control when the restarted, If it is in Traction Control.

### **⚠ WARNING**

Traction mode is a device applied for 2WD(2 wheel drive) vehicles. Please do not drive too hard on rough roads where 4WD(4 wheel drive) vehicles performance are required.

Invalid mode selection can lead to loss of traction and skidding, particularly on slippery roads, this can cause you to lose control of the vehicle, which can lead to accidents and serious injuries.

## Traction mode operation

Traction mode offers special traction tuning for snow/mud/sand, optimizing available traction in adverse conditions. Traction mode adjusts left and right wheel slip control, engine torque and shift patterns according to available traction levels.

### Driving in sand or mud

- Maintain slow and constant speed. Operate the accelerator pedal slowly to ensure safe driving (wheel-slip prevention).
- Use tyre chains driving in mud if necessary.
- Keep sufficient distance between your vehicle and the vehicle in front of you.
- Reduce vehicle speed and always check the road condition.
- Avoid speeding, rapid acceleration, sudden brake applications, and sharp turns to prevent getting stuck.

### **\* NOTICE**

- Moving the car forcibly to get out of mud or sand can cause damage/overheat of the engine or damage/breakdown of the transmission as well as damage to tyres. If excessive wheel slip occurs after entering a sandy/muddy road, the vehicle may fall into the sand/mud. When it happens, put a stone or a tree branch under the tyre, and then try to pull out the car, or try to get it unstuck by repeatedly moving forwards and backwards.
- When the vehicle is stuck in snow, sand or mud, the tyres may not operate. This is to protect the transmission and not a malfunction.



## Transmission overheated



the normal driving condition, stop the vehicle and apply the foot brake or shift into P (Park). Then allow the transmission to cool for a few minutes with engine on, before driving off.

- When the message "Trans cooled. Resume driving" appears you can continue to drive your vehicle.

If the warning messages in the LCD display continue to blink, for your safety, have the system checked by a professional workshop. Kia recommends to visit an authorised Kia dealer/service partner.

- When driving on muddy and sandy roads under the severe condition, the transmission could be overheated.
- When the transmission is overheated, the safe protection mode engages and the "Transmission Hot! Park with engine on" warning message will appear on the LCD display with a chime.
- If this occurs, pull over to a safe location, stop the vehicle with the engine running, apply the brakes and shift the vehicle to P (Park), and allow the transmission to cool.
- If you ignore this warning, the driving condition may become worse. You may experience abrupt shifts, frequent shifts, or jerkiness. To return to

## Economical operation

Your vehicle's fuel economy depends mainly on your style of driving, where you drive and when you drive.

Each of these factors affects how many kilometers you can get from a litre of fuel. To operate your vehicle as economically as possible, use the following driving suggestions to help save money in both fuel and repairs:

- Drive smoothly. Accelerate at a moderate rate. Don't make "jackrabbit" starts or full-throttle shifts and maintain a steady cruising speed. Don't race between stoplights. Try to adjust your speed to the traffic so you don't have to change speeds unnecessarily. Avoid heavy traffic whenever possible.
- Always maintain a safe distance from other vehicles so you can avoid unnecessary braking. This also reduces brake wear.
- Drive at a moderate speed. The faster you drive, the more fuel your vehicle uses. Driving at a moderate speed, especially on the highway, is one of the most effective ways to reduce fuel consumption.
- Don't "ride" the brake pedal. This can increase fuel consumption and also increase wear on these components. In addition, driving with your foot resting on the brake pedal may cause the brakes to overheat, which reduces their effectiveness and may lead to more serious consequences.
- Take care of your tyres. Keep them inflated to the recommended pressure. Incorrect inflation, either too much or too little, results in unnecessary tyre wear. Check the tyre pressures at least once a month.

- Be sure that the wheels are aligned correctly. Improper alignment can result from hitting kerbs or driving too fast over irregular surfaces. Poor alignment causes faster tyre wear and may also result in other problems as well as greater fuel consumption.
- Keep your car in good condition. For better fuel economy and reduced maintenance costs, maintain your car in accordance with the maintenance schedule in "Scheduled maintenance service" on page 8-10. If you drive your car in severe conditions, more frequent maintenance is required (Refer to "Maintenance Under Severe Usage Conditions" on page 8-14 for details).
- Keep your car clean. For maximum service, your vehicle should be kept clean and free of corrosive materials. It is especially important that mud, dirt, ice, etc. not be allowed to accumulate on the underside of the car. This extra weight can result in increased fuel consumption and also contribute to corrosion.
- Travel lightly. Don't carry unnecessary weight in your car. Weight reduces fuel economy.
- Don't let the engine idle longer than necessary. If you are waiting (and not in traffic), turn off your engine and restart only when you're ready to go.
- Remember, your vehicle does not require extended warm-up. After the engine has started, allow the engine to run for 10 to 20 seconds prior to placing the vehicle in gear. In very cold weather, however, give your engine a slightly longer warm-up period.

- Don't "lug" or "over-rev" the engine. Lugging is driving too slowly in too high a gear resulting in the engine bucking. If this happens, shift to a lower gear. Over-revving is racing the engine beyond its safe limit. This can be avoided by shifting at the recommended speeds.
- Use your air conditioning sparingly. The air conditioning system is operated by engine power so your fuel economy is reduced when you use it.
- Open windows at high speeds can reduce fuel economy.
- Fuel economy is less in crosswinds and headwinds. To help offset some of this loss, slow down when driving in these conditions.

Keeping a vehicle in good operating condition is important both for economy and safety. Therefore, have the system serviced by a professional workshop.

Kia recommends to visit an authorised Kia dealer/service partner.

### **⚠ WARNING**

#### **Engine off during motion**

Never turn the engine off to coast down hills or anytime the vehicle is in motion. The power steering and power brakes will not function properly without the engine running. Instead, keep the engine on and downshift to an appropriate gear for engine braking effect. In addition, turning off the ignition whilst driving could engage the steering wheel lock resulting in loss of vehicle steering which could cause serious injury or death.

## **Special driving conditions**

If driving conditions deteriorate due to poor weather or road conditions, you should pay even more attention than usual to your driving.

### **Hazardous driving conditions**

When hazardous driving conditions are encountered such as water, snow, ice, mud, sand, or similar hazards, follow these suggestions:

- Drive cautiously and allow extra distance for braking.
- Avoid sudden braking or steering.
- When braking with non-ABS brakes pump the brake pedal with a light up-and-down motion until the vehicle is stopped.
- Do not pump the brake pedal on a vehicle equipped with ABS.
- If stalled in snow, mud, or sand, use the second gear. Accelerate slowly to avoid spinning the drive wheels.
- Use sand, rock salt, or other nonslip material under the drive wheels to provide traction when stalled in ice, snow, or mud.

### **Reducing the risk of a rollover**

This multi-purpose passenger vehicle is defined as a Sports Utility Vehicle (SUV). SUV's have higher ground clearance and a narrower track to make them capable of performing in a wide variety of road applications. Specific design characteristics give them a higher centre of gravity than ordinary vehicles. An advantage of the higher ground clearance is a better view of the road, which allows you to anticipate problems. They are not designed for cornering at the same speeds as conventional passenger vehi-

cles. Due to this risk, driver and passengers are strongly recommended to buckle their seat belts. In a rollover crash, an unbelted person is more likely to die than a person wearing a seat belt. There are steps that a driver can make to reduce the risk of a rollover. If at all possible, avoid sharp turns or abrupt manoeuvres, do not load your roof rack with heavy cargo, and never modify your vehicle in any way.

### **⚠ WARNING**

#### **Rollover**

As with other Sports Utility Vehicle (SUV), failure to operate this vehicle correctly may result in loss of control, an accident or vehicle rollover.

- Utility vehicles have a significantly higher rollover rate than other types of vehicles.
- Specific design characteristics (higher ground clearance, narrower track, etc.) give this vehicle a higher centre of gravity than ordinary vehicles.
- A SUV is not designed for cornering at the same speeds as conventional vehicles.
- Avoid sharp turns or abrupt manoeuvres.
- In a rollover crash, an unbelted person is significantly more likely to die than a person wearing a seat belt. Make sure everyone in the vehicle is properly buckled up.

### **⚠ WARNING**

#### **Replacement tyres**

Always use the size and type of tyres recommended in the tyre section of the manual. Installation of variant tyres can

affect the safety and performance of your vehicle.

#### **Rocking the vehicle**

If it is necessary to rock the vehicle to free it from snow, sand, or mud, first turn the steering wheel right and left to clear the area around your front wheels. Then, shift back and forth between R (Reverse) and any forward gear.

Do not race the vehicle, and spin the wheels as little as possible. If you are still stuck after a few tries, have the vehicle pulled out by a tow vehicle to avoid vehicle overheating and possible damage to the transmission.

### **⚠ WARNING**

#### **Sudden Vehicle Movement**

Do not attempt to rock the vehicle if people or objects are nearby. The vehicle may suddenly move forward or backwards as it becomes unstuck.

### **⚠ CAUTION**

#### **Vehicle rocking**

Prolonged rocking may cause vehicle overheating, transmission damage or failure, and tyre damage.

### **⚠ CAUTION**

#### **Spinning tyres**

Do not spin the wheels, especially at speeds more than 56 km/h. Spinning the wheels at high speeds when the vehicle is stationary could cause a tyre to overheat which could result in tyre damage that may injure bystanders.

The Electronic Stability Control (ESC) should be turned OFF prior to rocking the vehicle.

### Smooth cornering

Avoid braking or gear changing in corners, especially when roads are wet. Ideally, corners should always be taken under gentle acceleration. If you follow these suggestions, tyre wear will be held to a minimum.

### Driving at night

Because night driving presents more hazards than driving in the daylight, here are some important tips to remember:

- Slow down and keep more distance between you and other vehicles, as it may be more difficult to see at night, especially in areas where there may not be any street lights.
- Adjust your mirrors to reduce the glare from other driver's headlights.
- Keep your headlights clean and properly aimed. (On vehicles not equipped with the automatic headlight aiming feature.) Dirty or improperly aimed headlights will make it much more difficult to see at night.
- Avoid staring directly at the headlights of oncoming vehicles. You could be temporarily blinded, and it will take several seconds for your eyes to readjust to the darkness.

### Driving in the rain

Rain and wet roads can make driving dangerous, especially if you're not prepared for the slick pavement. Here are a few things to consider when driving in the rain:

- A heavy rainfall will make it harder to see and will increase the distance needed to stop your vehicle, so slow down.
- Keep your windscreen wiping equipment in good shape. Replace your windscreen wiper blades when they show signs of streaking or missing areas on the windscreen.
- If your tyres are not in good condition, making a quick stop on wet pavement can cause a skid and possibly lead to an accident. Be sure your tyres are in good shape.
- Turn on your headlights to make it easier for others to see you.
- Driving too fast through large puddles can affect your brakes. If you must go through puddles, try to drive through them slowly.
- If you believe you may have gotten your brakes wet, apply them lightly whilst driving until normal braking operation returns.

### Driving in flooded areas

Avoid driving through flooded areas unless you are sure the water is no higher than the bottom of the wheel hub. Drive through any water slowly. Allow adequate stopping distance because brake performance may be affected.

After driving through water, dry the brakes by gently applying them several times whilst the vehicle is moving slowly.

### Driving on unpaved roads

Drive carefully on unpaved roads because your vehicle may be damaged by rocks or roots of trees. Become familiar with the on unpaved roads conditions

where you are going to drive before you begin driving.

## Highway driving

### Tyres

Adjust the tyre inflation pressures to specification. Low tyre inflation pressures will result in overheating and possible failure of the tyres.

Avoid using worn or damaged tyres which may result in reduced traction or tyre failure.

Never exceed the maximum tyre inflation pressure shown on the tyres.

### WARNING

#### Under/over inflated tyres

Always check the tyres for proper inflation before driving. Underinflated or overinflated tyres can cause poor handling, loss of vehicle control, and sudden tyre failure leading to accidents, injuries, and even death. For proper tyre pressures, refer to "Tyres and wheels" on page 9-9.

### WARNING

#### Tyre tread

Always check the tyre tread before driving your vehicle. Worn-out tyres can result in loss of vehicle control. Worn-out tyres should be replaced as soon as possible. For further information and tread limits, refer to "Tyres and wheels" on page 9-9.

## Fuel, engine coolant and engine oil

High speed travel consumes more fuel than urban motoring. Do not forget to

check both engine coolant and engine oil.

### Drive belt

A loose or damaged drive belt may result in overheating of the engine.

## Winter driving

Severe weather conditions in the winter result in greater wear and other problems.

To minimise the problems of winter driving, you should follow these suggestions:

### Summer tyres

Kia specifies summer tyres on some models to provide superior performance on dry roads. Summer tyre performance is substantially reduced in snow and ice. Summer tyres do not have the tyre traction rating M+S (Mud and Snow) on the tyre side wall. If you plan to operate your vehicle in snowy or icy conditions, Kia recommends the use of snow tyres or all season tyres on all four wheels.

### Snowy or icy conditions

To drive your vehicle in deep snow, it may be necessary to use snow tyres or to install tyre chains on your tyres.

If snow tyres are needed, it is necessary to select tyres equivalent in size and type of the original equipment tyres. Failure to do so may adversely affect the safety and handling of your vehicle. Furthermore, speeding, rapid acceleration, sudden brake applications, and sharp turns are potentially very hazardous practices.

During deceleration, use vehicle braking to the fullest extent. Sudden brake applications on snowy or icy roads may cause skids to occur. You need to keep sufficient distance between the vehicle in operation in front of your vehicle. Also, apply the brake gently. It should be noted that installing tyre chains on the

tyre will provide a greater driving force, but will not prevent side skids.

### Snow tyres

If you mount snow tyres on your vehicle, make sure they are radial tyres of the same size and load range as the original tyres. Mount snow tyres on all four wheels to balance your vehicle's handling in all weather conditions. Keep in mind that the traction provided by snow tyres on dry roads may not be as high as your vehicle's original equipment tyres. You should drive cautiously even when the roads are clear. Check with the tyre dealer for maximum speed recommendations.

#### WARNING

#### Snow tyre size

Snow tyres should be equivalent in size and type to the vehicle's standard tyres. Otherwise, the safety and handling of your vehicle may be adversely affected.

Do not install studded tyres without first checking local, state and municipal regulations for possible restrictions against their use.

## Tyre chains

Wire Type



OSP21053058

Fabric Type



OSP21060029

Since the sidewalls of radial tyres are thinner, they can be damaged by mounting some types of snow chains on them. Therefore, the use of snow tyres is recommended instead of snow chains. Do not mount tyre chains on vehicles equipped with aluminum wheels; snow chains may cause damage to the wheels. If snow chains must be used, use fabric-type chains for 17 inch and 18 inch tyres or wire-type chains with a thickness of less than 12 mm (0.47 in) for 16 inch tyres. Damage to your vehicle caused by improper snow chain use is not covered by your vehicle manufacturer's warranty.

Install tyre chains only on the front tyres. Do not exceed 30 km/h (20 mph) or the chain manufacturer's recommended speed limit, whichever is lower.

### ⚠ CAUTION

- Make sure the snow chains are the correct size and type for your tyres. Incorrect snow chains can cause damage to the vehicle body and suspension and may not be covered by your vehicle manufacturer warranty. Also, the snow chain connecting hooks may be damaged from contacting vehicle components causing the snow chains to come loose from the tyre. Make sure the snow chains are SAE class "S" certified.
- Always check chain installation for proper mounting after driving approximately 0.5 to 1 km to ensure safe mounting. Retighten or remount the chains if they are loose.
- Fabric-type chains must be used on the vehicle with 17 inch (215/60R17) and 18 inch (215/55R18) tyres.
- Even with the appropriate chain installed, do not make a full turn (turn the steering wheel fully to one side) when driving the vehicle. (If you are making a full turn, drive with the speed below 10 km/h.)

### Chain installation

When installing chains, follow the manufacturer's instructions and mount them as tightly as you can. Drive slowly with chains installed. If you hear the chains contacting the body or chassis, stop and tighten them. If they still make contact, slow down until it stops. Remove the chains as soon as you begin driving on cleared roads.



**⚠ WARNING****Mounting chains**

When mounting snow chains, park the vehicle on level ground away from traffic. Turn on the vehicle Hazard Warning flashers and place a triangular emergency warning device behind the vehicle if available. Always place the vehicle in P (Park), apply the parking brake and turn off the engine before installing snow chains.

**⚠ WARNING****Tyre chains**

- The use of chains may adversely affect vehicle handling.
- Do not exceed 30 km/h or the chain manufacturer's recommended speed limit, whichever is lower.
- Drive carefully and avoid bumps, holes, sharp turns, and other road hazards, which may cause the vehicle to bounce.
- Avoid sharp turns or locked wheel braking.

**⚠ CAUTION**

- Chains that are the wrong size or improperly installed can damage your vehicle's brake lines, suspension, body and wheels.
- Stop driving and retighten the chains any time you hear them hitting the vehicle.

**Use high quality ethylene glycol coolant**

Your vehicle is delivered with high quality ethylene glycol coolant in the cooling system. It is the only type of coolant that

should be used because it helps prevent corrosion in the cooling system, lubricates the water pump and prevents freezing. Be sure to replace or replenish your coolant refer to "Normal maintenance schedule" on page 8-12. Before winter, have your coolant tested to assure that its freezing point is sufficient for the temperatures anticipated during the winter.

**Check battery and cables**

Winter puts additional burdens on the battery system. Visually inspect the battery and cables (refer to "For best battery service" on page 8-36). The level of charge in your battery can be checked by an authorised Kia dealer or a service station.

**Change to "winter weight" oil if necessary**

In some climates it is recommended that a lower viscosity "winter weight" oil be used during cold weather. Refer to "Recommended lubricants and capacities" on page 9-10 for recommendations. If you aren't sure what weight oil you should use, Kia recommends to consult an authorised Kia dealer/service partner.

**Check spark plugs and ignition system**

Inspect your spark plugs as described in "Scheduled maintenance service" on page 8-10 and replace them if necessary. Also check all ignition wiring and components to be sure they are not cracked, worn or damaged in any way.

### **To keep locks from freezing**

To keep the locks from freezing, squirt an approved de-icer fluid or glycerine into the key opening. If a lock is covered with ice, squirt it with an approved de-icing fluid to remove the ice. If the lock is frozen internally, you may be able to thaw it out by using a heated key. Handle the heated key with care to avoid injury.

### **Use approved window washer anti-freeze in system**

To keep the water in the window washer system from freezing, add an approved window washer anti-freeze solution in accordance with instructions on the container. Window washer anti-freeze is available from an authorised Kia dealer and most auto parts outlets. Do not use vehicle coolant or other types of anti-freeze as these may damage the paint finish.

### **Don't let your parking brake freeze**

Under some conditions your parking brake can freeze in the engaged position. This is most likely to happen when there is an accumulation of snow or ice around or near the rear brakes or if the brakes are wet. If there is a risk the parking brake may freeze, apply it only temporarily whilst you put the gear shift dial in P (Park) and block the rear wheels so the vehicle cannot roll. Then release the parking brake.

### **Don't let ice and snow accumulate underneath**

Under some conditions, snow and ice can build up under the fenders and

interfere with the steering. In severe winter conditions you should periodically check underneath the vehicle to be sure the movement of the front wheels and the steering components are not obstructed.

### **Carry emergency equipment**

Depending on the severity of the weather, you should carry appropriate emergency equipment. Some of the items you may want to carry include tow straps or chains, flashlight, emergency flares, sand, shovel, jumper cables, window scraper, gloves, ground cloth, coveralls, blanket, etc.

### **Drive your vehicle when water vapour condenses and accumulates inside the exhaust pipes**

When the vehicle is stopped for a long time in winter whilst the engine is running, water vapour may condense and accumulate inside the exhaust pipes. Water in the exhaust pipes may cause noise, etc., but it is drained driving at medium to high speed.

5

## Vehicle weight

This section will guide you in the proper loading of your vehicle and/or trailer, to keep your loaded vehicle weight within its design rating capability, with or without a trailer.

Properly loading your vehicle will provide maximum return of the vehicle design performance. Before loading your vehicle, familiarize yourself with the following terms for determining your vehicle's weight ratings, with or without a trailer, from the vehicle's specifications and the compliance label:

**Base kerb weight** This is the weight of the vehicle including a full tank of fuel and all standard equipment. It does not include passengers, cargo, or optional equipment.

**Vehicle kerb weight** This is the weight of your new vehicle when you picked it up from your dealer plus any aftermarket equipment.

**Cargo weight** This figure includes all weight added to the Base Kerb Weight, including cargo and optional equipment.

**GAW (Gross Axle Weight)** This is the total weight placed on each axle (front and rear) - including vehicle kerb weight and all payload.

**GAWR (Gross Axle Weight Rating)** This is the maximum allowable weight that can be carried by a single axle (front or rear). These numbers are shown on the compliance label. The total load on each axle must never exceed its GAWR.

**GVW (Gross Vehicle Weight)** This is the Base Kerb Weight plus actual Cargo Weight plus passengers.

**GVWR (Gross Vehicle Weight Rating)** This is the maximum allowable weight of the fully loaded vehicle (including all options, equipment, passengers and

cargo). The GVWR is shown on the certification label located on the driver's door sill.

### CAUTION

Do not use replacement tyres with lower load carrying capacities than the original tyres because they may lower your vehicle's GVWR and GAWR limitations. Replacement tyres with a higher limit than the original tyres do not increase the GVWR and GAWR limitations.

## Overloading

### WARNING

### Vehicle weight

The gross axle weight rating (GAWR) and the gross vehicle weight rating (GVWR) for your vehicle are on the certification label attached to the driver's (or front passenger's) door. Exceeding these ratings can cause an accident or vehicle damage. You can calculate the weight of your load by weighing the items (and people) before putting them in the vehicle. Be careful not to overload your vehicle.

# Driver assistance system 6

<b>Forward Collision-Avoidance Assist (FCA) (Sensor fusion) ....</b>	<b>6-4</b>
• Basic function .....	6-4
• Junction Turning function .....	6-4
• Detecting sensor.....	6-4
• Forward Collision-Avoidance Assist settings .....	6-5
• Forward Collision-Avoidance Assist operation .....	6-7
• Forward Collision-Avoidance Assist malfunction and limitations.....	6-11
<b>Lane Keeping Assist (LKA).....</b>	<b>6-17</b>
• Detecting sensor.....	6-17
• Lane Keeping Assist settings .....	6-18
• Lane Keeping Assist operation.....	6-18
• Lane Keeping Assist malfunction and limitations.....	6-21
<b>Blind-Spot Collision-Avoidance Assist (BCA) .....</b>	<b>6-24</b>
• Detecting sensor.....	6-25
• Blind-Spot Collision-Avoidance Assist settings.....	6-25
• Blind-Spot Collision-Avoidance Assist operation .....	6-27
• Blind-Spot Collision-Avoidance Assist malfunction and limitations.....	6-29
<b>Safe Exit Warning (SEW) .....</b>	<b>6-33</b>
• Detecting sensor.....	6-33
• Safe Exit Warning settings .....	6-33
• Safe Exit Warning operation .....	6-34
• Safe Exit Warning malfunction and limitations .....	6-35
• Limitations of Safe Exit Warning .....	6-36
<b>Manual Speed Limit Assist (MSLA) .....</b>	<b>6-37</b>
• Manual Speed Limit Assist operation.....	6-37
<b>Driver Attention Warning (DAW) .....</b>	<b>6-40</b>
• Driver Attention Warning settings .....	6-41
• Driver Attention Warning operation .....	6-41
• Driver Attention Warning malfunction and limitations.....	6-43

# 6 Driver assistance system

<b>Blind-Spot View Monitor (BVM)</b> .....	<b>6-46</b>
• Blind-Spot View Monitor settings .....	6-47
• Blind-Spot View Monitor operation.....	6-47
• Blind-Spot View Monitor malfunction.....	6-47
<b>Cruise Control (CC)</b> .....	<b>6-48</b>
• Cruise Control operation .....	6-48
<b>Smart Cruise Control (SCC)</b> .....	<b>6-52</b>
• Basic function .....	6-52
• Overtaking Acceleration Assist .....	6-52
• Detecting sensor .....	6-52
• Smart Cruise Control settings .....	6-52
• Smart Cruise Control operation.....	6-53
• Smart Cruise Control malfunction and limitations.....	6-61
<b>Lane Following Assist (LFA)</b> .....	<b>6-66</b>
• Detecting sensor .....	6-66
• Lane Following Assist settings .....	6-66
• Lane Following Assist malfunction and limitations.....	6-69
• Limitations of Lane Following Assist .....	6-69
<b>Rear View Monitor (RVM)</b> .....	<b>6-70</b>
• Detecting sensor .....	6-70
• Rear View Monitor operation.....	6-71
• Rear View Monitor malfunction and limitations.....	6-74
<b>Surround View Monitor (SVM)</b> .....	<b>6-74</b>
• Surround View Monitor settings.....	6-75
• Surround View Monitor operation.....	6-77
• Surround View Monitor malfunction and limitations.....	6-79
<b>Rear Cross-Traffic Collision-Avoidance Assist (RCCA)</b> .....	<b>6-80</b>
• Rear Cross-Traffic Collision-Avoidance Assist settings .....	6-80
• Rear Cross-Traffic Collision-Avoidance Assist operation.....	6-82
• Rear Cross-Traffic Collision-Avoidance Assist malfunction and limitations .....	6-85

# Driver assistance system **6**

<b>Reverse Parking Distance Warning (PDW) .....</b>	<b>6-89</b>
• Detecting sensor.....	6-89
• Reverse Parking Distance Warning Operation .....	6-90
• Reverse Parking Distance Warning settings.....	6-90
• Operation of Reverse Parking Distance Warning.....	6-91
<b>Forward/Reverse Parking Distance Warning (PDW) .....</b>	<b>6-93</b>
• Forward/Reverse Parking Distance Warning Settings .....	6-94
<b>Declaration of conformity .....</b>	<b>6-98</b>
• The radio frequency components (Front radar) complies: .....	6-98
• The radio frequency components (Rear corner radar) complies : .....	6-101

## Driver assistance system

### \* INFORMATION

Due to the infotainment software version, the description of each function of the driver assistance system may differ from the owner's manual.

## Forward Collision-Avoidance Assist (FCA) (Sensor fusion) (if equipped)

### Basic function

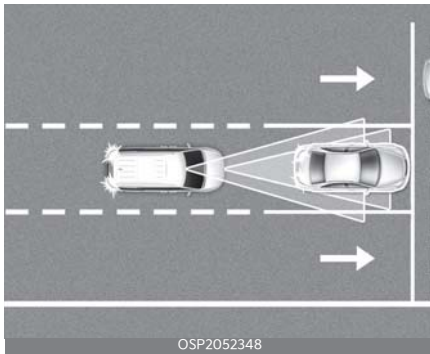

Forward Collision-Avoidance Assist is designed to help detect and monitor the vehicle ahead or help detect a pedestrian or cyclist in the roadway and warn the driver that a collision is imminent with a warning message, audible warning and apply emergency braking.

## Junction Turning function



Junction Turning function can help avoid a collision with an oncoming vehicle in an adjacent lane when turning left (left-hand drive) or right (right-hand drive) at a crossroad with the turn signal on by applying emergency braking.

### Detecting sensor

[1]: Front view camera, [2]: Front radar





Refer to the picture above for the detailed location of the detecting sensors.

### ⚠ CAUTION

- Never disassemble the detecting sensor or sensor assembly, or cause any damage to it.
- If the detecting sensor has been replaced or repaired, have the vehicle inspected by a professional workshop. Kia recommends to visit an authorised Kia dealer/service partner.
- Never install any accessories or stickers on the front windscreen, or tint the front windscreen.
- Pay extreme caution to keep the front view camera dry.
- Never place any reflective objects (for example, white paper, mirror) over the dashboard.
- Do not apply license plate frame or objects, such as a bumper sticker, film or a bumper guard, near the front radar cover.
- Always keep the front radar and cover clean and free of dirt and debris. Use only a soft cloth to wash the vehicle. Do not spray pressurized water directly on the sensor or sensor cover.

- If the radar or around the radar has been damaged or impacted in any way, Forward Collision-Avoidance Assist may not properly operate even though a warning message does not appear on the cluster. In this case, have the vehicle inspected by a professional workshop. Kia recommends to visit an authorised Kia dealer/service partner.
- The genuine Kia front radar sensor covers are parts with quality and performance ensured. If arbitrarily applying paint on or changing the cover, Forward Collision-Avoidance Assist may not function properly. Use only Kia Genuine Parts or those of an equivalent standard with proven quality and performance to repair or replace the radar sensor covers.
- Installing a trailer, carrier or other equipment adversely affect the detecting performance of the rear corner radar, or temporarily limit Forward Collision-Avoidance.

## Forward Collision-Avoidance Assist settings

### Forward safety





With the ENGINE START/STOP button in the ON position, select 'User settings → Driver assistance → Driving safety' on the LCD display or 'Settings → Vehicle → Driver assistance → Driving safety' on the Infotainment system screen to set whether to use the function.

- Forward safety : Depending on the collision risk levels, an audible warning will sound and the braking will be assisted. If the following menu is deactivated, Forward Collision-Avoidance Assist will turn off and the warning light (🚗) will appear on the cluster.

**⚠ WARNING**

Forward Collision-Avoidance Assist will maintain its last setting even if the vehicle is restarted. If Forward Safety is deselected, the driver should always be aware of the surroundings and drive safely.

**⚠ CAUTION**

Forward safety provides 'Basic function', and 'Junction Turning function'.

**Forward Safety Warning Timing**



With ENGINE START/STOP button in the ON position, select '**User settings → Driver assistance → Driving safety → Forward Safety Warning Timing**' on the LCD display or '**Settings → Vehicle → Driver assistance → Driving safety → Forward Safety Warning Timing**' on the Infotainment system screen to change the initial warning activation timing for Forward Collision-Avoidance Assist.

- Use 'Normal' in normal driving conditions. If the Warning Timing seems sensitive, change it to 'Late'.
- If 'Late' is selected, Forward Collision-Avoidance Assist warns the driver more slowly.

**⚠ CAUTION**

- Even though 'Normal' is selected for Warning Timing, if the front vehicle suddenly stops, the initial warning activation time may seem late.
- Select 'Late' only when driving in light traffic or at slow speed.

**\* NOTICE**

The warning timing you have set will be maintained even if the vehicle is restarted.

## Warning methods

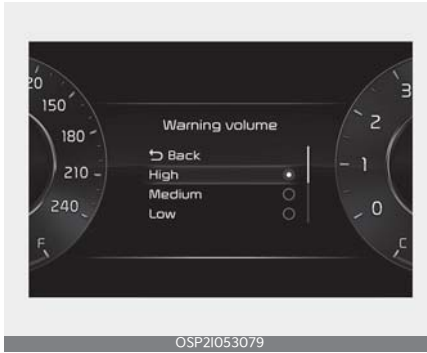

OSP21053079

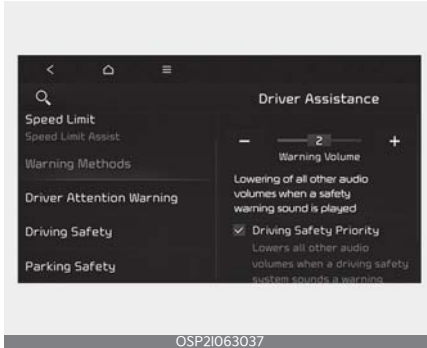

OSP21063037

You can adjust the Warning methods with ENGINE START/STOP button in the ON position.

- Warning volume : Select 'User settings → Driver assistance → Warning volume' on the LCD display or 'Settings → Vehicle → Driver assistance → Warning methods' on the Infotainment system.
- Driving safety priority : Select 'Settings → Vehicle → Driver assistance → Warning methods → Driving safety priority' on the Infotainment system. For safe driving, the audio volume will temporarily decrease to warn the driver with the audible warning.

### \* NOTICE

- Ensure that Warning methods you have set may apply to the warning volume of other Driver Assistance systems.
- Warning methods will maintain its last setting even if the vehicle is restarted.
- The setting menu may not be available for your vehicle depending on the vehicle features and specifications.

## Forward Collision-Avoidance Assist operation

### Basic function

The basic function for Forward Collision-Avoidance Assist is to warn and help control the vehicle depending on the collision risk level.

- Collision warning
- Emergency braking
- Stopping vehicle and ending brake control

### Collision warning



OSP21053117

Collision warning will alert the driver with a warning message, an audible warning and steering wheel vibration (if equipped).

- For vehicle: Approximately 10~200 km/h (6~124 mph)
- Pedestrian or cyclist: Approximately 10~85 km/h (6~53 mph)

**Emergency braking**

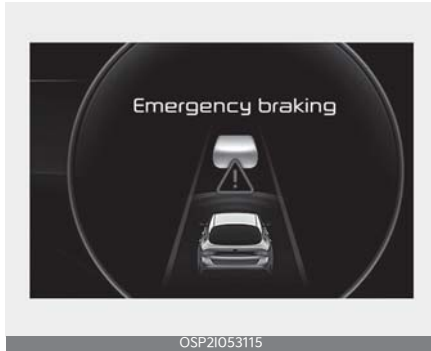

Emergency braking will alert the driver with a forward safety warning light

 , a warning message and an audible warning. The brake assist will be activated and it helps avoiding collision of a vehicle, pedestrian and cyclist. Emergency braking will be activated in your driving speed and the following conditions.

- For vehicle:

Driving target	Stopped target	
Weak braking power	Approximately 10~200 km/h (6~124 mph)	
Strong braking power	Approximately 10~85 km/h (6~53 mph)	Approximately 10~75 km/h (6~47 mph)

- For pedestrian or cyclist: 10~65 km/h (6~40 mph)

**⚠ CAUTION**

The function operation range may decrease due to the front traffic condition or the surroundings of the vehicle.

**Stopping vehicle and ending brake control**



When the vehicle is stopped due to emergency braking, the 'Drive carefully' warning message will appear on the cluster.

For your safety, the driver should depress the brake pedal immediately and check the surroundings.

- Brake control will end after the vehicle is stopped by emergency braking for approximately 2 seconds.

**Junction Turning function**

The basic function for Junction turning function is to warn and help control the vehicle depending on the collision risk level.

- Collision Warning
- Emergency Braking
- Stopping vehicle and ending brake control

## Collision warning



Collision warning will alert the driver with a forward safety warning light

, a warning message and an audible warning. Collision warning will be activated in the following conditions.

- Your driving speed: Approximately 10~30 km/h (6~19 mph)
- Oncoming vehicle speed: Approximately 30~70 km/h (19~44 mph)

## Emergency braking



Emergency braking will alert the driver with a forward safety warning light

, a warning message and an audible warning. The brake assist will be activated and it helps avoiding collision of a

vehicle. Emergency braking will be activated in the following conditions.

- Your driving speed: Approximately 10~30 km/h (6~19 mph)
- Oncoming vehicle speed: Approximately 30~70 km/h (19~44 mph)

## Stopping vehicle and ending brake control



When the vehicle is stopped due to emergency braking, the warning message will appear on the cluster. For your safety, the driver should depress the brake pedal immediately and check the surroundings.

- Brake control will end after the vehicle is stopped by emergency braking for approximately 2 seconds.

### WARNING

- For your safety, change the Settings after parking the vehicle at a safe location.
- The driver should hold the responsibility to control the vehicle. Do not solely depend on Forward Collision-Avoidance Assist. Rather, maintain a safe braking distance, and if necessary, depress the brake pedal to reduce driving speed or to stop the vehicle.

- Forward Collision-Avoidance Assist does not operate in all situations or cannot avoid all collisions.
- Never deliberately operate Forward Collision-Avoidance Assist on people, objects, etc. It may cause serious injury or death.
- Forward Collision-Avoidance Assist may not operate if the driver depresses the brake pedal to avoid collision.
- During Forward Collision-Avoidance Assist operation, the vehicle may stop suddenly injuring passengers and shifting loose objects. Always have the seat belt on and keep loose objects secured.
- If any other function's warning message is displayed or audible warning is generated, Forward Collision-Avoidance Assist warning message may not be displayed and audible warning may not be generated.
- You may not hear the warning sound of Forward Collision-Avoidance Assist if the surrounding is noisy. Adjust the warning volume vehicle appropriately, and always be aware of the surroundings and drive safely.
- Even if there is a problem with Forward Collision-Avoidance Assist, the vehicle's basic braking performance will operate properly.
- During emergency braking, braking control by Forward Collision-Avoidance Assist will automatically cancel when the driver excessively depresses the accelerator pedal or sharply steers the vehicle.

**⚠ CAUTION**

- The surroundings and pedestrians, cyclists or other vehicles in front of you may affect the speed or detection range to operate Forward Collision-Avoidance Assist, resulting in Forward Collision-Avoidance Assist temporarily limited or disabled.
- Forward Collision-Avoidance Assist will operate under certain conditions by determining the risk level depending on the surroundings and other vehicles' driving directions or speed.
- Driving at excessively higher or lower speed than other vehicles can temporarily limit or disable Forward Collision-Avoidance Assist.



**\* NOTICE**

- When a collision is imminent, the Forward Collision-Avoidance Assist may assist the driver with brakes if the driver fails to brake.
- The images and colours in the instrument cluster may differ depending on the cluster type or theme selected from the settings menu.

## Forward Collision-Avoidance Assist malfunction and limitations

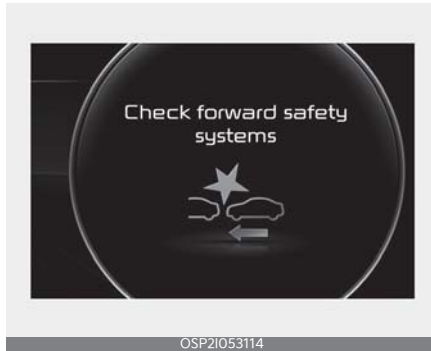
### Forward Collision-Avoidance Assist malfunction



When Forward Collision-Avoidance Assist is not working properly, the warning message will appear and the  and  warning lights will appear on the cluster.



In this case, have the vehicle inspected by a professional workshop. Kia recommends to visit an authorised Kia dealer/service partner.

### Forward Collision-Avoidance Assist disabled



When the front windshield where the front view camera is located, front radar

cover or sensor is covered with foreign material, such as snow or rain or inclement weather, such as heavy rain, fog, it can reduce the detecting performance and temporarily limit or disable Forward Collision-Avoidance Assist.

If this occurs the warning message, and the  and  warning lights will appear on the cluster.

Forward Collision-Avoidance Assist will operate properly when snow, rain or foreign material is removed.

If Forward Collision-Avoidance Assist does not operate properly after obstruction (snow, rain, or foreign material) is removed Kia recommends visiting an authorized Kia dealer/service partner.

#### WARNING

- Even though the warning message or warning light does not appear on the cluster, Forward Collision-Avoidance Assist may not properly operate.
- Forward Collision-Avoidance Assist may not properly operate in an area (for example, open terrain), where any objects are not detected after turning ON the engine.
- Even if restarting the vehicle with the sensors blocked or malfunctioned, Forward Collision-Avoidance Assist may not properly operate as the function maintains the last setting.

### Limitations of Forward Collision-Avoidance Assist

Forward Collision-Avoidance Assist may not operate properly or it may operate unexpectedly under the following circumstances:

- The detecting sensor or the surroundings are contaminated or damaged

## Driver assistance system

## Forward Collision-Avoidance Assist (FCA) (Sensor fusion)

- The temperature around the front view camera is high or low due to the external environment
- The camera lens is contaminated due to tinted, filmed or coated windscreen, damaged glass, or sticky foreign matters (sticker, bug, etc.) on the glass
- Moisture is not removed or frozen on the windscreen
- Washer fluid is continuously sprayed, or the wiper is on
- Driving in heavy rain or snow, or thick fog
- The field of view of the front view camera is obstructed by sun glare
- Street light or light from an oncoming traffic is reflected on the wet road surface, such as a puddle on the road
- An object is placed on the dashboard
- Your vehicle is being towed
- The surrounding is very bright
- The surrounding is very dark, such as in a tunnel, etc.
- The brightness changes suddenly, for example when entering or exiting a tunnel
- The brightness outside is low, and the headlamps are not on or are not bright
- Driving through steam, smoke or shadow
- Only part of the vehicle, pedestrian or cyclist is detected
- The vehicle in front is a bus, heavy truck, truck with an unusually shaped cargo, trailer, etc.
- The vehicle in front has no tail lights, tail lights are located unusually, etc.
- The brightness outside is low, and the tail lamps are not on or are not bright
- The rear of the front vehicle is small or the vehicle does not look normal, such as when the vehicle is tilted, overturned, or the side of the vehicle is visible, etc.
- The front vehicle's ground clearance is low or high
- A vehicle, pedestrian or cyclist suddenly cuts in front
- The bumper around the front radar is impacted, damaged or the front radar is out of position
- The temperature around the front radar is high or low
- Driving through a tunnel or iron bridge
- Driving in large areas where there are few vehicles or structures (for example, desert, meadow, suburb, etc.)
- Driving near areas containing metal substances, such as a construction zone, railroad, etc.
- A material is near that reflects very well on the front radar, such as a guardrail, nearby vehicle, etc.
- The cyclist in front is on a bicycle made of material that does not reflect on the front radar
- The vehicle in front is detected late
- The vehicle in front is suddenly blocked by an obstacle
- The vehicle in front suddenly changes lane or suddenly reduces speed
- The vehicle in front is bent out of shape
- The vehicle in front is covered with snow
- You are departing or returning to the lane
- You are driving unstably

- You are on a roundabout and the vehicle in front is not detected
- You are continuously driving in a circle
- The vehicle in front has an unusual shape
- The vehicle in front is driving uphill or downhill
- The pedestrian or cyclist is not fully detected, for example, if the pedestrian is leaning over or is not fully walking upright
- The pedestrian or cyclist is wearing clothing or equipment that makes it difficult to detect as a pedestrian or cyclist

Following image shows the image the sensor recognizes as vehicle, pedestrian, and cyclist.



- The pedestrian or cyclist is wearing clothing that easily blends into the background, making it difficult to detect
  - The pedestrian or cyclist is difficult to distinguish from the similarly shaped structure in the surroundings
  - You are driving by a pedestrian, cyclist traffic signs, structures, etc. near the intersection
  - Driving in a parking lot
  - Driving through a tollgate, construction area, unpaved road, partial paved road, uneven road, speed bumps, etc.
  - Driving on an incline road, curved road, etc.
  - Driving through a roadside with trees or streetlights
  - The adverse road conditions cause excessive vehicle vibrations whilst driving
  - Your vehicle height is low or high due to heavy loads, abnormal tyre pressure, etc.
  - Driving through a narrow road where trees or grass are overgrown
  - There is interference by electromagnetic waves, such as driving in an area with strong radio waves or electrical noise
  - The adverse road conditions cause excessive vehicle vibrations whilst driving
  - Your vehicle height is low or high due to heavy loads, abnormal tyre pressure, etc.
- The pedestrian or cyclist in front is moving very quickly
  - The pedestrian or cyclist in front is short or is posing a low posture
  - The pedestrian or cyclist in front has impaired mobility
  - The pedestrian or cyclist in front is moving intersected with the driving direction
  - There is a group of pedestrians, cyclists or a large crowd in front



**WARNING**

- **Driving on a curved road**

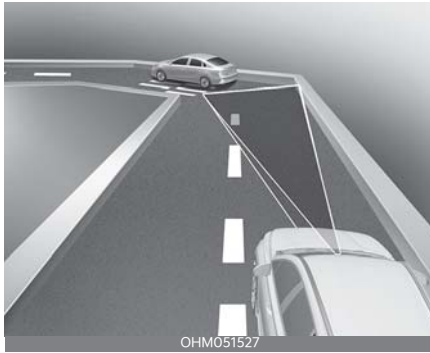

Forward Collision-Avoidance Assist may not detect the vehicle, pedestrian or cyclist travelling in front on a curved road.

Always pay attention to road and driving conditions, and if necessary, depress the brake pedal to reduce your driving speed in order to maintain a safe distance.

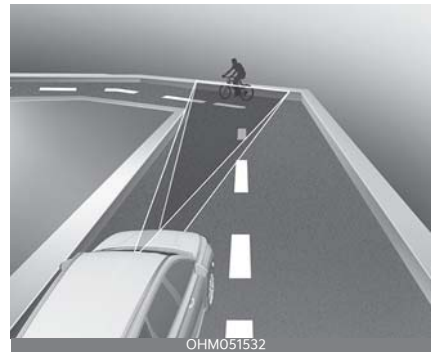
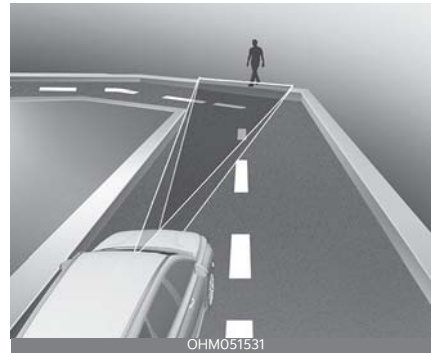

Forward Collision-Avoidance Assist may detect the vehicle, pedestrian or cyclist in the next lane or outside the

lane when driving on a curved road. If this occurs, Forward Collision-Avoidance Assist may unnecessarily warn the driver and control the brake. Always check the traffic conditions around the vehicle.

- **Driving on an inclined road**



Forward Collision-Avoidance Assist may not detect other vehicle, pedestrian or cyclist in front whilst driving uphill or downhill and this may result in no warning, or braking assist when necessary.

When Forward Collision-Avoidance Assist suddenly recognizes the vehicle, pedestrian or cyclist in front whilst passing over a slope, you may experience sharp deceleration.

Always keep your eyes forward whilst driving upward or downward on a slope, and, if necessary, depress the brake pedal to reduce your driving speed in order to maintain distance.

- **Changing lanes**

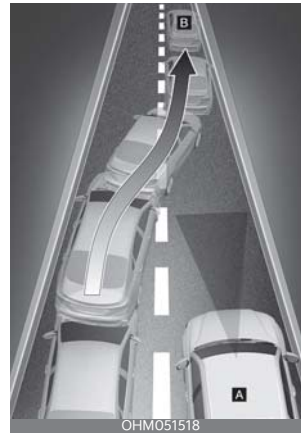

[A]: Your vehicle

[B]: Lane changing vehicle

When a vehicle changes lanes in front of you, Forward Collision-Avoidance Assist may not immediately detect the vehicle, especially if the vehicle changes lanes abruptly. In this case, you must maintain a safe braking distance, and if necessary, depress the brake pedal to reduce your driving

speed in order to maintain a safe distance.

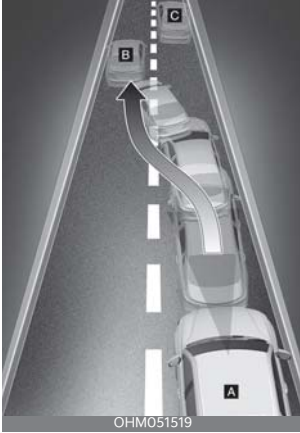

[A]: Your vehicle

[B]: Lane changing vehicle

[C]: Same lane vehicle

When driving in stop-and-go traffic, and a stopped vehicle in front of you merges out of the lane, Forward Collision-Avoidance Assist may not immediately detect the new vehicle that is now in front of you. In this case, you must maintain a safe braking distance, and if necessary, depress the brake pedal to reduce your driving speed in order to maintain a safe distance.

### • Detecting vehicle



When the vehicle in front has heavy loading extended rearward, or when the vehicle in front has higher ground clearance, it may induce a hazardous situation. Always pay attention to road and driving conditions, whilst driving and, if necessary, depress the brake pedal to reduce your driving speed in order to maintain distance.

### ⚠ WARNING

- When you are towing a trailer or another vehicle, we recommend that Forward Collision-Avoidance Assist is turned off due to safety reasons.
- Forward Collision-Avoidance Assist may operate if objects that are similar in shape or characteristics to vehicles, pedestrians or cyclists are detected.
- Forward Collision-Avoidance Assist does not operate on bicycles, or smaller wheeled objects, such as luggage bags, shopping carts, or strollers that are dragged by a pedestrian or a cyclist.
- Forward Collision-Avoidance Assist may not operate properly if interfered by strong electromagnetic waves.

- Forward Collision-Avoidance Assist may not operate for 15 seconds after the vehicle is started, or the front view camera is initialized.

### Lane Keeping Assist (LKA) (if equipped)

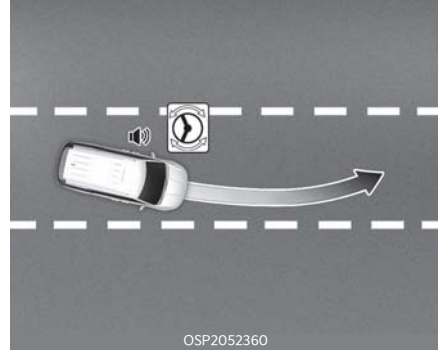

Lane Keeping Assist is designed to help detect lane markings (or road edges) whilst driving over a certain speed. Lane Keeping Assist will warn the driver if the vehicle leaves the lane without using the turn signal, or will automatically assist the driver's steering to help prevent the vehicle from departing the lane.

### Detecting sensor

[1]: Front view camera



The front view camera is used as a detecting sensor to detect lane markings (or road edges).

Refer to the picture above for the detailed location of the detecting sensor.

**CAUTION**

For more details on the precautions of the front view camera, refer to "Forward Collision-Avoidance Assist (FCA) (Sensor fusion) (if equipped)" on page 6-4.

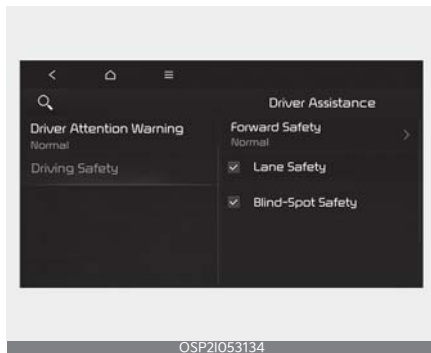
**Lane Keeping Assist settings****Lane safety**

With ENGINE START/STOP button in the ON position, select 'User settings → Driver assistance → Driving safety' on the LCD display or 'Settings → Vehicle → Driver assistance → Driving safety' on the Infotainment system screen to set whether to use the function.

- Lane safety : If Lane Safety is selected, Lane Keeping Assist will automatically assist the driver's steering when lane departure is detected to help prevent the vehicle from moving out of its lane. If Lane Safety is off, the yellow indicator light (  ) will appear on the cluster.

**WARNING**

- Lane Keeping Assist does not control the steering wheel when the vehicle is driven in the middle of the lane.

- If **Lane safety** is deselected, the driver cannot get assistance from Lane Keeping Assist. Always drive carefully.

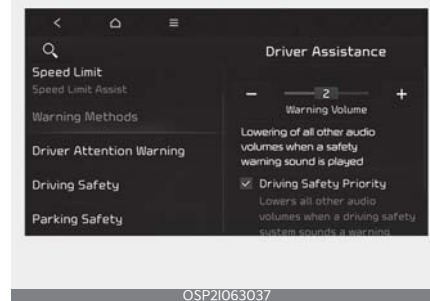
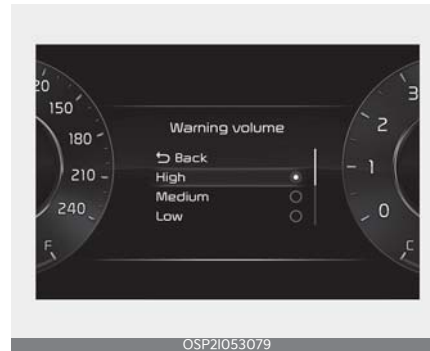
**Lane Keeping Assist operation****Warning methods**

You can adjust the Warning methods with ENGINE START/STOP button in the ON position.

- Warning volume : Select 'User settings → Driver assistance → Warning volume' on the LCD display or 'Settings → Vehicle → Driver assistance → Warning methods' on the Infotainment system.
- Driving safety priority : Select 'Settings → Vehicle → Driver assistance → Warning methods → Driving safety priority' on the Infotainment system.

priority' on the Infotainment system. For safe driving, the audio volume will temporarily decrease to warn the driver with the audible warning.

**\* NOTICE**

- Ensure that Warning methods you have set may apply to the warning volume of other Driver Assistance systems.
- Warning methods will maintain its last setting even if the vehicle is restarted.
- The setting menu may not be available for your vehicle depending on the vehicle features and specifications.

**Turning Lane Keeping Assist On/Off**



- With the vehicle ON, press and hold the Lane Driving Assist button (LKA icon) to turn on/off Lane Keeping Assist. If Lane Keeping Assist is activated, the indicator (LKA icon) will be displayed on the cluster.

**\* NOTICE**

- When Lane Keeping Assist is turned off by pressing the Lane Driving Assist button (LKA icon), Lane Safety will be deselected.

- Whenever the vehicle is turned off and on, Lane safety settings will always retain its settings.

**Warning and control**

Left



Right



Lane Keeping Assist will warn and help control the vehicle with Lane Departure Warning and Lane Keeping Assist.

**Lane Departure Warning**

Lane Departure Warning will warn the driver that the vehicle is departing from with a green (LKA icon) indicator light, lane blinking in the direction the vehicle departed from, and an audible warning. Lane departure warning will be activated in the following conditions.

- Your driving speed: Approximately 60~200 km/h (40~120 mph)

### Lane Keeping Assist

The green (🚗) indicator light will blink on the cluster, and the steering wheel will make adjustments to prevent that the vehicle is departing from the projected lane in front.

Lane Keeping Assist will be activated in the following conditions.

- Your driving speed: Approximately 60~200 km/h (40~120 mph)

### Hands-off warning

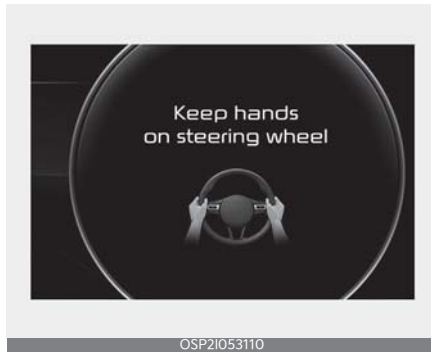

OSP21053110

If the driver takes their hands off the steering wheel for several seconds, the warning message will appear on the cluster, and an audible warning will sound in stages.

### ⚠ WARNING

- The steering wheel may not be assisted if the steering wheel is held very tight or the steering wheel is steered over a certain degree.
- Lane Keeping Assist does not operate at all times. It is the responsibility of the driver to safely steer the vehicle and to maintain the vehicle in its lane.
- The hands-off warning message may appear late depending on road condi-

tions. Always have your hands on the steering wheel whilst driving.

- If the steering wheel is held very lightly, the hands off warning message may appear because Lane Keeping Assist may not recognize that the driver has their hands on the steering wheel.
- If you attach objects to the steering wheel, the hands-off warning may not work properly.

### \* NOTICE

- For more details on setting the functions in the infotainment system, refer to "LCD display" on page 4-49.
- When lane markings (or road edges) are detected, the lane lines on the cluster will change from grey to white and the green (🚗) indicator light will appear.

Lane undetected

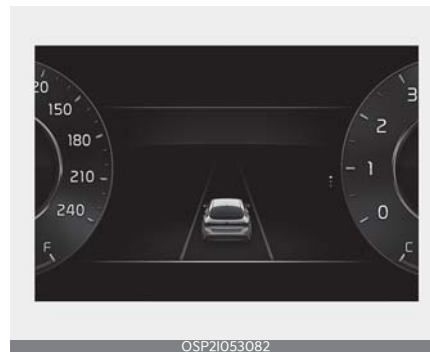

OSP21053082

Lane detected



- The images and colours in the instrument cluster may differ depending on the cluster type or theme selected from the settings menu.
- Even though the steering is assisted by Lane Keeping Assist, the driver may control the steering wheel.
- The steering wheel may feel heavier or lighter when the steering wheel is assisted by Lane Keeping Assist than when it is not.

**Lane Keeping Assist malfunction and limitations**

**Lane Keeping Assist malfunction**

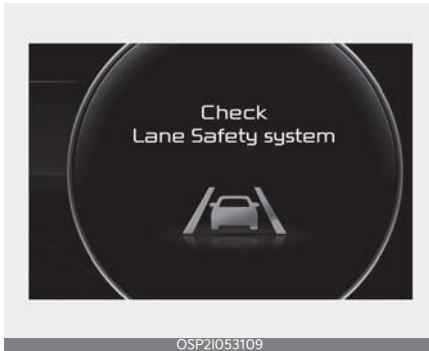

When Lane Keeping Assist is not working properly, the warning message will

appear and the yellow (🚗) indicator light will illuminate on the cluster. If this occurs, have the function checked by a professional workshop. Kia recommends to visit an authorised Kia dealer/service partner.

**Lane Keeping Assist disabled**

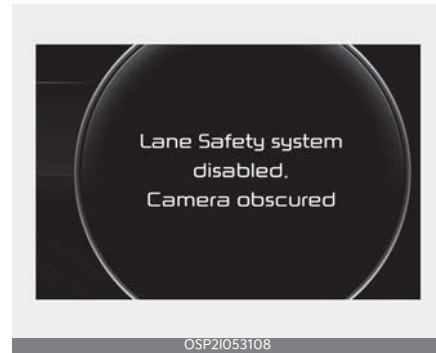

When the front windshield where the front view camera is located, is covered with foreign material, such as snow or rain, it can reduce the detecting performance and temporarily limit or disable Lane Keeping Assist.

If this occurs, the warning message, the master warning light and the Lane Safety warning lights will appear on the cluster. However, it is not a malfunction. Lane Keeping Assist will operate properly when snow, rain or foreign material is removed. Always keep it clean.

If Lane Keeping Assist does not operate properly after obstruction (snow, rain, or foreign material) is removed (including trailer, carrier, etc. from the rear bumper), have the vehicle checked by a professional workshop. Kia recommends to visit an authorized Kia dealer/service partner.



**⚠ WARNING**

- Lane Keeping Assist may not properly operate without displaying any warning messages or warning lights on the cluster.
- Even if restarting the vehicle with the sensors blocked or malfunctioned, Lane Keeping Assist may not properly operate as the function maintains the last setting.

**Limitations of Lane Keeping Assist**

Lane Keeping Assist may not operate properly or may operate unexpectedly under the following circumstances:

- The lane is contaminated or difficult to detect because,
  - The lane markings (or road edges) are covered with rain, snow, dirt, oil, etc.
  - The colour of the lane markings (or road edges) is not distinguishable from the road
  - There are markings (or road edges) on the road near the lane or the markings on the road look similar to the lane markings (or road edges)
  - The lane markings (or road edges) is indistinct or damaged
  - The shadow is on the lane markings (or road edges) by a median strip, trees, guardrail, noise barriers, etc.
- There are more than two lane markings (or road edges) on the road
- The lane number increases or decreases, or the lane markings (or road edges) are crossing

- The lane markings (or road edges) are complicated or a structure substitutes for the lines, such as a construction area
- There are road markings (or road edges), such as zigzag lanes, crosswalk markings and road signs
- The lane suddenly disappears, such as at the intersection
- The lane (or road width) is very wide or narrow
- There is a road edge without a lane
- There is a boundary structure in the roadway, such as a tollgate, sidewalk, kerb, etc.
- The distance to the front vehicle is extremely short or the vehicle in front is covering the lane markings (or road edges)

**\* NOTICE**

For more details on the limitations of the front view camera, refer to "Forward Collision-Avoidance Assist (FCA) (Sensor fusion) (if equipped)" on page 6-4.

**⚠ WARNING**

- The driver should hold the responsibility to safely drive and control the vehicle. Do not solely rely on Lane Keeping Assist and drive dangerously.
- The operation of Lane Keeping Assist can be cancelled or not work properly depending on road conditions, surroundings and lane markings (or road edges). Always be cautious whilst driving.
- Refer to "Limitations of Lane Keeping Assist" on page 6-22, if the lane is not detected properly.
- When you are towing a trailer or another vehicle, we recommend that

Lane Keeping Assist is turned off due to safety reasons.

- If the vehicle is driven at high speed, the steering wheel will not be controlled. The driver must always follow the speed limit when using Lane Keeping Assist.
- If any other function's warning message is displayed or audible warning is generated, Lane Keeping Assist warning message may not be displayed and audible warning may not be generated.
- You may not hear the warning sound of Lane Keeping Assist if the surrounding is noisy.
- If you attach objects to the steering wheel, steering may not be assisted properly.
- Lane Keeping Assist may not operate for 15 seconds after the vehicle is started, or the front view camera is initialized.
- Lane Keeping Assist will not operate when:
  - Turning the turn signal or within the time after turned off
  - The vehicle is not driven in the centre of the lane when Lane Keeping Assist is turned on or right after changing a lane
  - ESC (Electronic Stability Control) or VSM (Vehicle Stability Management) is activated
  - The vehicle is driven on a sharp curve
  - Vehicle speed is below 55 km/h (35 mph) or above 200 km/h (120 mph)
  - The vehicle makes sharp lane changes

- The vehicle brakes suddenly
-

## Blind-Spot Collision-Avoidance Assist (BCA) (if equipped)

The collision warning will alert the driver with a warning light and audible warning if a possible collision with approaching vehicles in the driver's blind spot area is detected. In addition, if there is a risk of collision when driving forward out of a parking space, Blind-Spot Collision-Avoidance Assist can help avoid a collision by applying the brake.



Blind-Spot Collision-Avoidance Assist helps detect and informs the driver that a vehicle is in the blind spot.

### ⚠ CAUTION

The detecting range may vary depending on the speed of your vehicle. Even if there is a vehicle in the blind spot area, Blind-Spot Collision-Avoidance Assist may not warn you when you pass by at high speeds.

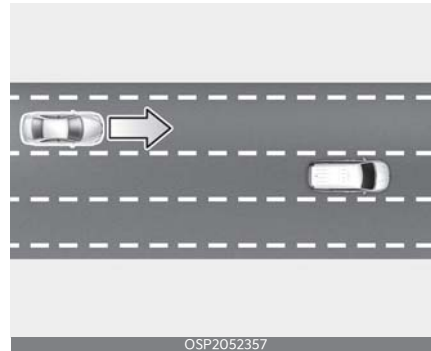

Blind-Spot Collision-Avoidance Assist helps detect and informs the driver that a vehicle is approaching at high speed from the blind spot area.

### ⚠ CAUTION

Warning Timing may vary depending on the speed of the vehicle approaching at high speed.

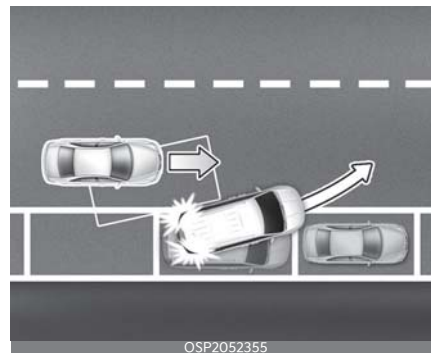

When you are driving forward out of a parking space, if Blind-Spot Collision-Avoidance Assist judges that there is a collision risk with an approaching vehicle in the blind spot, it can help avoid collisions by applying the brake.

## Detecting sensor

[1]: Rear corner radar



OSP2IGT063039

Refer to the picture above for the detailed location of the detecting sensors.

### CAUTION

- Never disassemble the rear corner radar or radar assembly, or cause any damage to it.
- If the rear corner radar or near the radar has been damaged or impacted in any way, even though the warning message does not appear on the cluster, Blind-Spot Collision-Avoidance Assist may not operate properly. In this case, have your vehicle inspected by a professional workshop. Kia recommends to contact an authorised Kia dealer/service partner.
- If the detecting sensors have been replaced or repaired, have the vehicle checked by a professional workshop. Kia recommends to visit an authorized Kia dealer/service partner.
- The genuine Kia rear bumpers which the Rear corner radar sensors are mounted are parts with quality and performance ensured. If arbitrarily applying paint on or changing the bumper, the Blind-Spot Collision-

Avoidance Assist may not function properly.

Use only Kia Genuine Parts or those of an equivalent standard with proven quality and performance to repair or replace the bumper.

- Do not arbitrarily attach or add vehicle wraps, accessories, license plate molds and stickers on or around the rear corner radar.
- If a trailer, carrier, etc., is installed, it may adversely affect the performance of the rear corner radar or Blind-Spot Collision-Avoidance Assist may not operate.

## Blind-Spot Collision-Avoidance Assist settings

### Blind-spot safety



OSP2IO53145

With ENGINE START/STOP button in the ON position, select 'User settings → Driver assistance → Driving safety' on the LCD display or 'Settings → Vehicle → Driver assistance → Driving safety' on the Infotainment system screen to set whether to use the function.

- Blind-spot safety : Blind-Spot Collision-Avoidance Assist will warn and braking assist will be applied depending on the collision risk levels.



When activating Blind-Spot Collision-Avoidance Assist or restarting the vehicle with this function activated, the warning light on the side mirrors will appear for approximately 3 seconds. When the vehicle is restarted with Blind-Spot Collision-Avoidance Assist inactivated, the warning message will appear on the cluster.

**WARNING**

If Blind-Spot Safety is deselected, the driver should always be aware of the surroundings and drive safely.

**\* NOTICE**

If the engine is restarted, Blind-Spot Collision-Avoidance Assist will maintain the last setting.

**Warning methods**

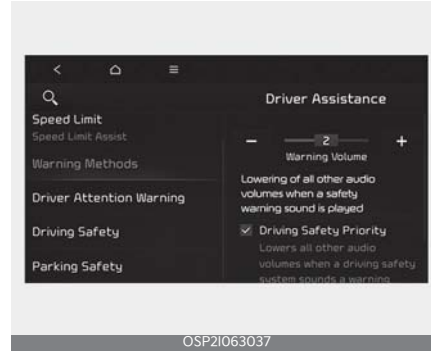
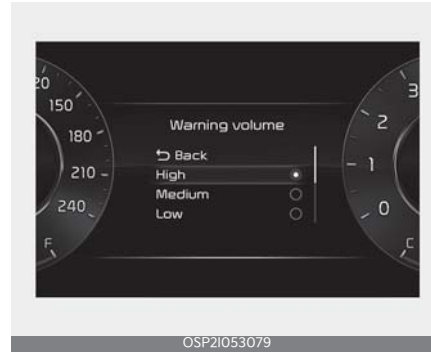

You can adjust the Warning methods with ENGINE START/STOP button in the ON position.

- Warning volume : Select 'User settings → Driver assistance → Warning volume' on the LCD display or 'Settings → Vehicle → Driver assistance → Warning methods' on the Infotainment system.
- Driving safety priority : Select 'Settings → Vehicle → Driver assistance → Warning methods → Driving safety priority' on the Infotainment system. For safe driving, the audio volume will temporarily decrease to warn the driver with the audible warning.

**\* NOTICE**

- Ensure that Warning methods you have set may apply to the warning volume of other Driver Assistance systems.
- Warning methods will maintain its last setting even if the vehicle is restarted.
- The setting menu may not be available for your vehicle depending on the vehicle features and specifications.

**Blind-Spot Collision-Avoidance Assist operation**

Blind-Spot Collision-Avoidance Assist will warn and control as following operation.

- Vehicle detection
- Collision Warning
- Collision-Avoidance Assist

**Collision Warning**

When a vehicle from both lanes is detected from the rear, the warning light on the instrument cluster, rear view mirror (side view mirror), and head-up display (if equipped) will appear.

A vehicle is detected in the following conditions.

- Your driving speed: Above 20 km/h (12 mph)
- The speed of the vehicle in your blind spot area: Above 10 km/h (7 mph)

With the vehicle detection state, collision warning will alert the driver when the turn signal is activated to make a lane change with an adjacent car in the blind spot area.

- Collision warning will alert the driver with the warning light on the cluster, outside rear view mirrors (side view mirrors) and head-up display (if equipped), audible warning.
- When the turn signal is turned off or you move away from the lane, the collision warning will be cancelled and Blind-Spot Collision-Avoidance Assist will return to vehicle detection state.

**⚠ WARNING**

- The detecting range of the rear corner radar is determined by a standard road width, therefore, on a narrow road, Blind-Spot Collision-Avoidance Assist may detect other vehicles two lanes over and warn you. In contrast, on a wide road, Blind-Spot Collision-Avoidance Assist may not be able to detect a vehicle driving in the next lane and may not warn you.
- When the hazard warning flasher is on, the collision warning by the turn signal will not operate.

## Collision-Avoidance Assist (whilst departing)

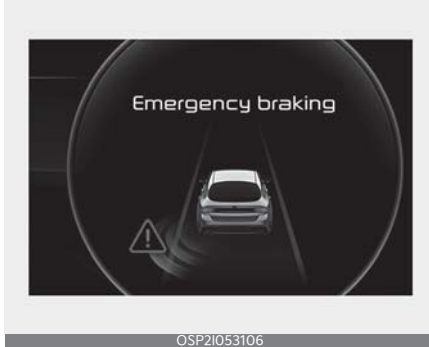

The warning light on the outside rear view mirror (side view mirror), head-up display (if equipped) and an audible warning will warn the driver of a collision. It assists in braking control to prevent a collision with a vehicle approaching from the blind spot area. Collision-Avoidance Assist will be activated in the following conditions.

- Your driving speed: Below 3 km/h (2 mph)
- Speed of the vehicle in your blind spot area: Above 5 km/h (3 mph)



When the vehicle is stopped due to emergency braking, the 'Drive carefully' warning message will appear on the cluster.

For your safety, the driver should depress the brake pedal immediately and check the surroundings.

- Brake control will end after the vehicle is stopped by emergency braking for approximately 2 seconds.

### ⚠ WARNING

- For your safety, change the settings after parking the vehicle at a safe location.
- If any other function's warning message is displayed or audible warning is generated, Blind-Spot Collision-Avoidance Assist's warning message may not be displayed and audible warning may not be generated.
- Vehicle interior/exterior noise may disturb the driver from hearing the audible warning of Blind-Spot Collision-Avoidance Assist. Always pay attention and keep the vehicle volume at a moderate level.
- Blind-Spot Collision-Avoidance Assist may not operate if the driver applies the brake pedal to avoid collision.
- When Blind-Spot Collision-Avoidance Assist is operating, braking control by the function will automatically cancel when the driver excessively depresses the accelerator pedal or sharply steers the vehicle.
- If changing the gear quickly during reversing the vehicle, Blind-Spot Collision-Avoidance Assist may not work or may operate unnecessarily.
- During Blind-Spot Collision-Avoidance Assist operation, the vehicle may stop suddenly injuring passengers and shifting loose objects. Always have the seat belt on and keep loose objects secured.

- Even if there is a problem with Blind-Spot Collision-Avoidance Assist, the vehicle's basic braking performance will operate properly.
- Blind-Spot Collision-Avoidance Assist does not operate in all situations or cannot avoid all collisions.
- Blind-Spot Collision-Avoidance Assist may warn the driver late or may not warn the driver depending on the road and driving conditions.
- Driver should maintain control of the vehicle at all times. Do not depend on Blind-Spot Collision-Avoidance Assist. Maintain a safe braking distance, and if necessary, depress the brake pedal to reduce driving speed or to stop the vehicle.
- Never test Blind-Spot Collision-Avoidance Assist on people, animal, objects, etc. It may cause serious injury or death.

**⚠ WARNING**

The brake control may not operate properly depending on the status of ESC (Electronic Stability Control).

There will only be a warning when:

- The ESC (Electronic Stability Control) warning light is on.
- ESC (Electronic Stability Control) is engaged in a different function.

**Blind-Spot Collision-Avoidance Assist malfunction and limitations**

**Blind-Spot Collision-Avoidance Assist malfunction**

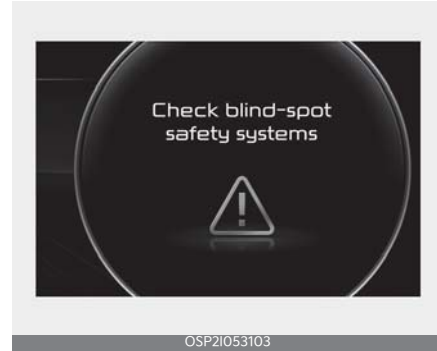

When Blind-Spot Collision-Avoidance Assist is not working properly, the warning message will appear on the cluster for several seconds, and the master (⚠) warning light will appear on the cluster for several seconds. If this occurs, have the vehicle checked by a professional workshop. Kia recommends to visit an authorized Kia dealer/service partner.

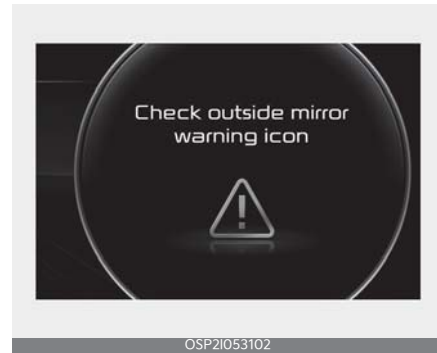

When the outside rearview mirror warning light is not working properly, the warning message will appear on the cluster for several seconds, and the master (⚠) warning light will appear on



the cluster. If this occurs, have the vehicle checked by a professional workshop. Kia recommends to visit an authorized Kia dealer/service partner.

### Blind-Spot Collision-Avoidance Assist disabled

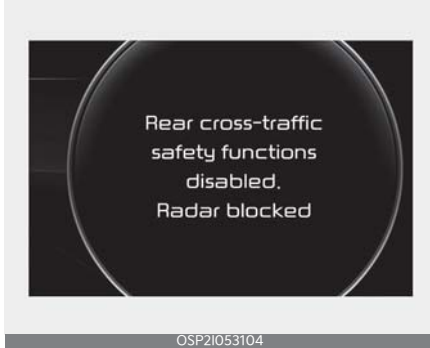

When the rear bumper around the rear corner radar or sensor is covered with foreign material, such as snow or rain, or installing a trailer or carrier, it can reduce the detecting performance and temporarily limit or disable Blind-Spot Collision-Avoidance Assist.

If this occurs, the warning message will appear on the cluster.

Blind-Spot Collision-Avoidance Assist will operate properly when such foreign material or trailer, etc., is removed, and then the vehicle is restarted.

If Blind-Spot Collision-Avoidance Assist does not operate properly after it is removed, have the vehicle checked by a professional workshop. Kia recommends to visit an authorized Kia dealer/service partner.

#### **WARNING**

- Even though the warning message does not appear on the cluster, Blind-Spot Collision-Avoidance Assist may not properly operate.

- Blind-Spot Collision-Avoidance Assist may not properly operate in an area (for example, open terrain), where any objects are not detected right after the engine is turned on, or when the detecting sensor is blocked with foreign material right after the engine is turned on.

#### **CAUTION**

Turn off Blind-Spot Collision-Avoidance Assist to install or remove a trailer, carrier, or another attachment. Turn on Blind-Spot Collision-Avoidance Assist when finished.

### Limitations of Blind-Spot Collision-Avoidance Assist

Blind-Spot Collision-Avoidance Assist may not operate properly or it may operate unexpectedly under the following circumstances:

- There is inclement weather, such as heavy snow, heavy rain, etc.
- The rear corner radar is covered with snow, rain, dirt, etc.
- The temperature around the rear corner radar is high or low
- Driving on a highway (or motorway) ramp
- The road pavement (or the peripheral ground) abnormally contains metallic components (for example, possibly due to subway construction).
- There is a fixed object near the vehicle, such as sound barriers, guardrails, central dividers, entry barriers, street lamps, signs, tunnels, walls, etc. (including double structures)
- Driving in vast areas where there are few vehicles or structures (for example, desert, meadow, suburb, etc.)

## Driver assistance system

- Driving through a narrow road where trees or grass are overgrown
- Driving on a wet road surface, such as a puddle on the road
- The other vehicle drives very close behind your vehicle, or the other vehicle passes by your vehicle in close proximity
- The speed of the other vehicle is very fast that it passes by your vehicle in a short time
- Your vehicle passes by the other vehicle
- Your vehicle change lane
- Your vehicle has started at the same time as the vehicle next to you and has accelerated
- The vehicle in the next lane moves two lanes away from you, or when the vehicle two lanes away moves to the next lane from you
- A trailer or carrier is installed around the rear corner radar
- The bumper around the rear corner radar is covered with objects, such as a bumper sticker, bumper guard, bike rack, etc.
- The bumper around the rear corner radar is impacted, damaged or the radar is out of position
- Your vehicle height is low or high due to heavy loads, abnormal tyre pressure, etc.

Blind-Spot Collision-Avoidance Assist may not operate properly or it may operate unexpectedly when the following objects are detected:

- A powered two-wheeler or bicycle is detected
- A vehicle such as a flat trailer is detected

## Blind-Spot Collision-Avoidance Assist (BCA)

- A big vehicle such as a bus or truck is detected
- A moving obstacle such as a pedestrian, animal, shopping cart or a baby stroller is detected
- A vehicle with low height such as a sports car is detected

### WARNING

- **Driving on a curved road**



Blind-Spot Collision-Avoidance Assist may not operate properly when driving on a curved road. Blind-Spot Collision-Avoidance Assist may not detect the vehicle in the next lane.

Always pay attention to road and driving conditions whilst driving.



Blind-Spot Collision-Avoidance Assist may not operate properly when driving

## Driver assistance system

on the curved road. Blind-Spot Collision-Avoidance Assist may recognize the vehicle in the same lane.

Always pay attention to road and driving conditions whilst driving.

- **Driving on an inclined road**

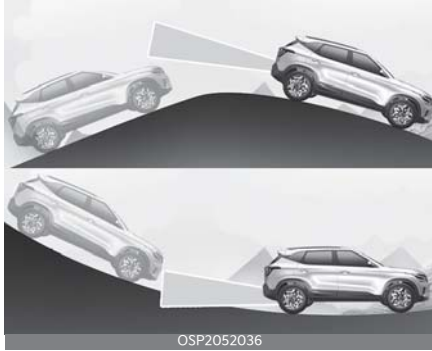

Blind-Spot Collision-Avoidance Assist may not operate properly when driving on a slope. Blind-Spot Collision-Avoidance Assist may not detect the vehicle in the next lane or may incorrectly detect the ground or structure.

Always pay attention to road and driving conditions whilst driving.

- **Driving where the road is merging/dividing**

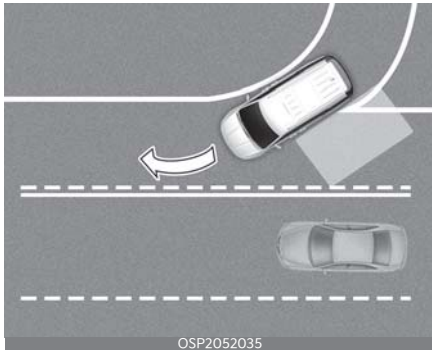

Blind-Spot Collision-Avoidance Assist may not operate properly when driving where the road merges or divides. Blind-

## Blind-Spot Collision-Avoidance Assist (BCA)

Spot Collision-Avoidance Assist may not detect the vehicle in the next lane.

Always pay attention to road and driving conditions whilst driving.

- **Driving where the heights of the lanes are different**



Blind-Spot Collision-Avoidance assist may not operate properly when driving where the heights of the lanes are different. Blind-Spot Collision-Avoidance Assist may not detect the vehicle on a road with different lane heights (underpass joining section, grade separated intersections, etc.).

Always pay attention to road and driving conditions whilst driving.

### ⚠ WARNING

- When you are towing a trailer or another vehicle, make sure that you turn off Blind-Spot Collision-Avoidance Assist.
- Blind-Spot Collision-Avoidance Assist may not operate properly if interfered with by strong electromagnetic waves.
- Blind-Spot Collision-Avoidance Assist may not operate for 3 seconds after the vehicle is started, or the rear corner radars are initialized.

## Safe Exit Warning (SEW) (if equipped)

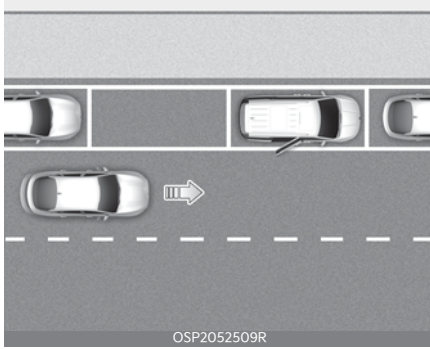

After the vehicle stops, when an approaching vehicle from the rear area is detected as soon as a passenger opens a door, Safe Exit Warning will warn the driver with a warning message and an audible warning to help prevent a collision.

### ⚠ CAUTION

Warning timing may vary depending on the speed of the approaching vehicle.

## Detecting sensor

[1]: Rear corner radar



Refer to the picture for the detailed location of the detecting sensors.

### \* NOTICE

For more details on the precautions of the rear corner radars, refer to "Blind-Spot Collision-Avoidance Assist (BCA) (if equipped)" on page 6-24.

## Safe Exit Warning settings

### Safe exit



With ENGINE START/STOP button in the ON position, and select 'User settings → Driver assistance → Driving safety → Safe exit' on the instrument cluster or 'Settings → Vehicle → Driver assistance → Driving safety → Safe exit' on the infotainment system.

### ⚠ WARNING

If 'Safe exit' is deselected, Safe Exit Warning cannot warn you. The driver should always be aware of unexpected and sudden situations from occurring.

### \* NOTICE

If the vehicle is restarted, Safe Exit Warning will maintain the last setting.

## Warning methods



You can adjust the Warning methods with ENGINE START/STOP button in the ON position.

- Warning volume: Select 'User settings → Driver assistance → Warning volume' on the instrument cluster or 'Settings → Vehicle → Driver assistance → Warning methods' on the infotainment system.
- Driving safety priority: Select 'Settings → Vehicle → Driver assistance → Warning methods → Driving Safety Priority' on the infotainment system. For safe driving, the audio volume will temporarily decrease to warn the driver with the audible warning.

## \* INFORMATION

- Ensure that Warning methods you have set may apply to the Warning volume of other Driver assistance systems.
- Warning methods will maintain its last setting even if the vehicle is restarted.
- The setting menu may not be available for your vehicle depending on the vehicle features and specifications.

## Safe Exit Warning operation

Safe Exit Warning warns the following actions.

- Collision warning when exiting vehicle

## Collision warning when exiting vehicle





The warning light on the side view mirror will blink and the warning message will appear on the cluster, and an audible warning will sound.

- Safe Exit Warning will warn under the following circumstances:
  - Your driving speed: below 3 km/h (2 mph)
  - The speed of the approaching vehicle from the rear: above 6 km/h (4 mph)

#### **⚠ WARNING**

- For your safety, change the Settings after parking the vehicle at a safe location.
- If any other function's warning message is displayed or audible warning is generated, Safe Exit Warning message may not be displayed and audible warning may not be generated.
- You may not hear the warning sound of Safe Exit Warning if the surrounding is noisy.
- Safe Exit Warning does not operate in all situations or cannot prevent all collisions.
- Safe Exit Warning may warn the driver late or may not warn the driver depending on the road and driving

conditions. Always check vehicle surroundings.

- The driver and passengers are responsible for accidents that occurs whilst exiting the vehicle. Always check the surroundings before you exit the vehicle.

#### **\* NOTICE**

- After the engine is turned off, Safe Exit Warning operates approximately for 3 minutes, but turns off immediately if the doors are locked.
- Images or colours may be displayed differently depends on the instrument cluster specifications or theme.

### Safe Exit Warning malfunction and limitations

#### Safe Exit Warning malfunction

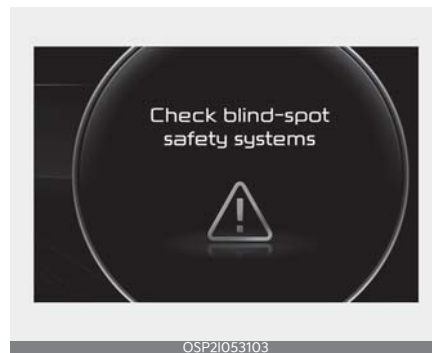

When Safe Exit Warning is not working properly, the warning message will appear on the cluster, and the master warning light (⚠) will appear on the cluster. In this case, have the vehicle checked by a professional workshop. Kia recommends to visit an authorized Kia dealer/service partner.

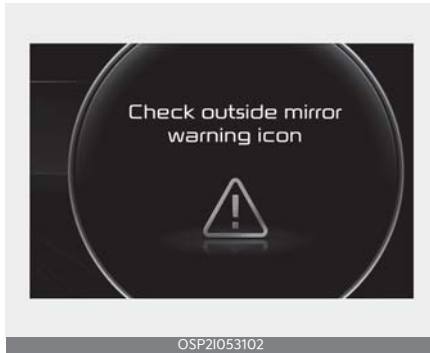

When the outside rear view mirror warning light is not working properly, the warning message will appear on the cluster for several seconds, and the master warning light (⚠️) will appear on the cluster. Have Safe Exit Warning be inspected by a professional workshop. Kia recommends visiting an authorised Kia dealer/service partner.

### Safe Exit Warning disabled

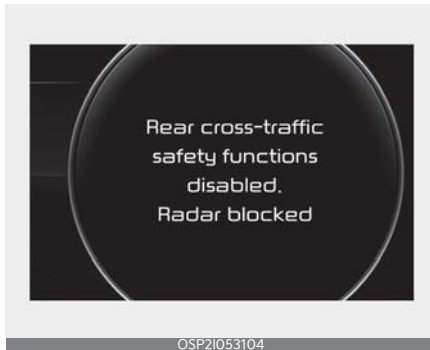

When the rear bumper around the rear-side radar or sensor is covered with foreign matters, such as snow or rain, or installing a trailer or carrier, it can reduce the detecting performance and temporarily limit or disable Safe Exit Warning.

If this occurs, the 'Blind-spot safety systems disabled. Radar blocked' warning message will appear on the cluster.

Safe Exit Warning will operate normally when such foreign matters or trailer, etc. is removed, and then the vehicle is restarted.

If Safe Exit Warning does not operate normally after it is removed, have your vehicle inspected by a professional workshop. Kia recommends to visit an authorised Kia dealer/service partner.

#### ⚠️ WARNING

- Even though the warning message does not appear on the cluster, Safe Exit Warning may not properly operate.
- Safe Exit Warning may not properly operate in an area (e.g., open terrain), where any substance are not detected right after the vehicle is turned on, or when the detecting sensor is blocked with foreign material right after the vehicle is turned on.

#### ⚠️ CAUTION

Turn off Safe Exit Warning to install a trailer, carrier, etc., or remove the trailer, carrier, etc. to use Safe Exit Warning.

### Limitations of Safe Exit Warning

Safe Exit Warning may not operate normally, or it may operate unexpectedly under the following circumstances:

- Getting out of the vehicle where trees or grass are overgrown.
- Getting out of the vehicle where the road is wet.
- The approaching vehicle is very fast or very slow.

**⚠ CAUTION**

For more details on the limitations of the rear corner radar, refer to "Blind-Spot Collision-Avoidance Assist (BCA) (if equipped)" on page 6-24.

**⚠ WARNING**

- Safe Exit Warning may not operate normally if interfered by strong electromagnetic waves.
- Safe Exit Warning may not operate for 3 seconds after the vehicle is started, or the rear corner radars are initialized.
- Even if restarting the vehicle with the sensors blocked or malfunctioned, Safe Exit Warning may not properly operate as the function maintains the last setting.

**Manual Speed Limit Assist (MSLA) (if equipped)**



1. Speed Limit indicator
2. Set speed

You can set the speed limit when you do not want to drive over a specific speed. If you drive over the preset speed limit, Manual Speed Limit Assist will operate (set speed limit will blink and chime will sound) until the vehicle speed returns within the speed limit.

**Manual Speed Limit Assist operation**

**Setting the speed limit**

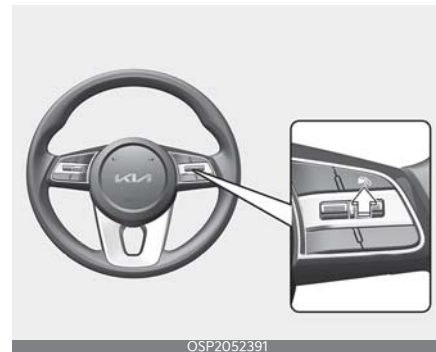

1. Press and hold the Driving Assist button on the steering wheel, at the



6



## Driver assistance system

- desired speed. The Speed Limit indicator will illuminate on the cluster.
2. Push the + switch up or - switch down, and release it at the desired speed.

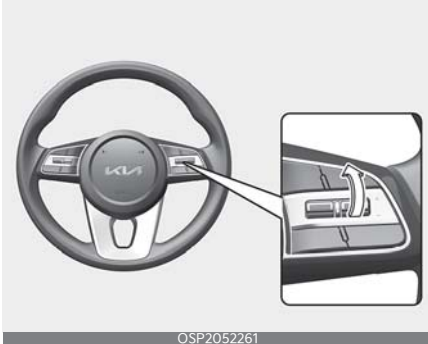

OSP2052261



OSP2052260

Push the + switch up or - switch down and hold it. The speed will increase or decrease to the nearest multiple of ten (multiple of five in mph) at first, and then increase or decrease by 10 km/h (5 mph).

3. The set speed limit will be displayed on the cluster. If you would like to drive over the preset speed limit, depress the accelerator pedal beyond the pressure point to activate the kick-down function.

The set speed limit will blink and chime will sound until you return the vehicle speed within the speed limit.

## Manual Speed Limit Assist (MSLA)



OSP21053084

### \* NOTICE

When the accelerator pedal is not depressed beyond the pressure point, vehicle speed will maintain within the speed limit.

### Temporarily pausing Manual Speed Limit Assist



OSP2052465

Press the ||⌚ switch to temporarily pause the set speed limit. The set speed limit will turn off but the Speed Limit indicator will stay on.

## Resuming Manual Speed Limit Assist



To resume Manual Speed Limit Assist after the function was paused, operate the +, - or || ↻ switch.

If you push the + switch up or - switch down, set speed will be set to the current speed on the cluster. If you press the || ↻ switch, set speed will resume to the preset speed.

## Turning off Manual Speed Limit Assist

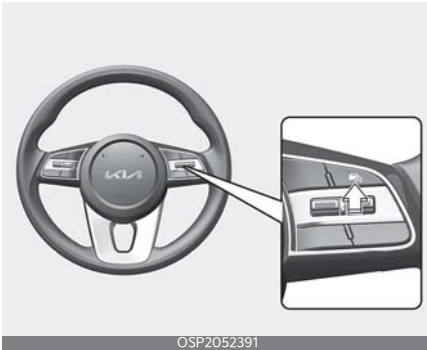

Press the Driving Assist button to turn Manual Speed Limit Assist off. The Speed Limit indicator will go off. Always press the Driving Assist button to turn Manual Speed Limit Assist off when not in use.

### ⚠ WARNING

Take the following precautions when using Manual Speed Limit Assist:

- Always set the vehicle speed to the speed limit in your country.
- Keep Manual Speed Limit Assist off when the function is not in use, to avoid inadvertently setting a speed. Check that the Speed Limit indicator is off.
- Manual Speed Limit Assist does not substitute for proper and safe driving. It is the responsibility of the driver to always drive safely and should always be aware of unexpected and sudden situations from occurring. Pay attention to the road conditions at all times.

## Warning methods

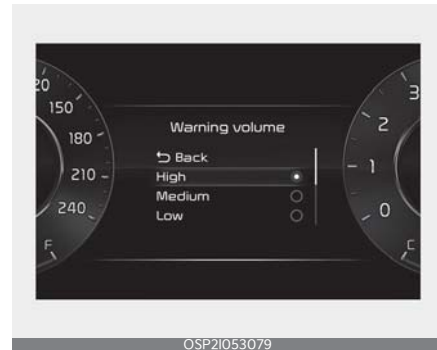

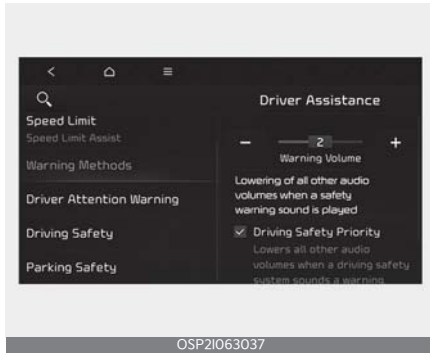

You can adjust the Warning methods with ENGINE START/STOP button in the ON position.

- Warning volume: Select 'User settings → Driver assistance → Warning volume' on the instrument cluster or 'Settings → Vehicle → Driver assistance → Warning methods' on the infotainment system.
- Driving safety priority: Select 'Settings → Vehicle → Driver assistance → Warning methods → Driving Safety Priority' on the infotainment system. For safe driving, the audio volume will temporarily decrease to warn the driver with the audible warning.

#### \* INFORMATION

- Ensure that Warning methods you have set may apply to the Warning volume of other Driver assistance systems.
- Warning methods will maintain its last setting even if the vehicle is restarted.
- The setting menu may not be available for your vehicle depending on the vehicle features and specifications.

## Driver Attention Warning (DAW) (if equipped)

### Basic function

Driver Attention Warning can help determine the driver's attention level by analyzing driving pattern and driving time while the vehicle is driven. Driver Attention Warning will recommend a break when the driver's attention level falls below a certain level.

### Leading Vehicle Departure Alert

Leading Vehicle Departure Alert will inform the driver when a detected vehicle in front departs from a stop.

### Detecting sensor

[1]: Front view camera



The front view camera is used as a detecting sensor to help detect driving patterns and front vehicle departure whilst vehicle is being driven.

Refer to the picture above for the detailed location of the detecting sensor.

#### ⚠ CAUTION

- Always keep the front view camera in good condition to maintain optimal

performance of Driver Attention Warning.

- For more details on the precautions of the front view camera, refer to "Forward Collision-Avoidance Assist (FCA) (Sensor fusion) (if equipped)" on page 6-4.

## Driver Attention Warning settings

### Driver Attention Warning

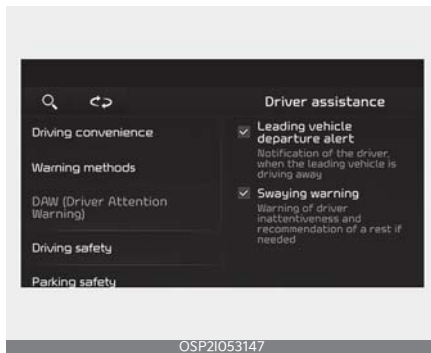

With the vehicle on, touch or deselect **Settings** → **Driver Assistance** → **Driver Attention Warning** on the instrument cluster or select **Settings** → **Vehicle** → **Driver Assistance** → **Driver Attention Warning** on the infotainment system.

- If **Inattentive Driving Warning** is selected, Driver Attention Warning will recommend taking a break when the level falls below a certain level.

#### \* NOTICE

Whenever the engine is turned on, **Inattentive Driving Warning** will always turn on. (For Europe, Russia)

### Leading vehicle departure alert



With ENGINE START/STOP button in the ON position, select 'User settings → Driver assistance → DAW (Driver Attention Warning)' on the LCD display or 'Settings → Vehicle → Driver assistance → DAW (Driver Attention Warning)' on the Infotainment system screen.

If 'Leading vehicle departure alert' is selected, the function will inform the driver when a detected vehicle in front departs from a stop.

### Driver Attention Warning operation

#### Basic function

The basic function of Driver Attention Warning is to inform the driver 'Consider taking a break'.

## Taking a break

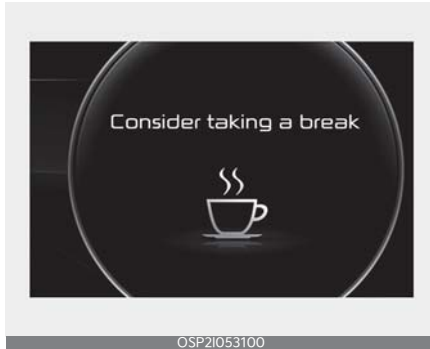

If the driver's attention level drops below a certain level, the function will alert the driver through an audible warning and the blinking indicator light (☺), along with a message encouraging the driver to take a break.

- Driver Attention Warning will not suggest a break when the total driving time is shorter than 4 minutes or 4 minutes has not passed after the last break was suggested.

Driver Attention Warning operates under the following conditions:

- Your driving speed: Approximately 0~200 km/h (0~120 mph)

### ⚠ WARNING

For your safety, only change the settings after parking the vehicle at a safe location.

### ⚠ CAUTION

- Driver Attention Warning may suggest a break depending on the driver's driving pattern or habits, even if the driver doesn't feel fatigue.
- Driver Attention Warning is a supplemental function and may not be able

to determine whether the driver is inattentive.

- The driver who feels fatigued should take a break at a safe location, even though there is no break suggestion by Driver Attention Warning.

### \* NOTICE

For more details on vehicle settings, refer to "Infotainment system" on page 4-126.

## Leading Vehicle Departure Alert



When a detected vehicle in front departs from a stop, Leading Vehicle Departure Alert will inform the driver by displaying the warning message on the cluster and an audible warning will sound.

### ⚠ WARNING

- If any other function's warning message is displayed or audible warning is generated, Leading Vehicle Departure Alert's warning message may not be displayed and audible warning may not be generated.
- The driver should hold the responsibility to safely drive and control the vehicle.

**⚠ CAUTION**

- Leading Vehicle Departure Alert is a supplemental function and may not warn the driver whenever the front vehicle departs from a stop.
- Always check the front of the vehicle and road conditions before driving even if the function alert you that the front vehicle has departed.

**\* NOTICE**

The images and colours in the instrument cluster may differ depending on the cluster type or theme selected from the settings menu.

**Driver Attention Warning malfunction and limitations**

**Driver Attention Warning malfunction**

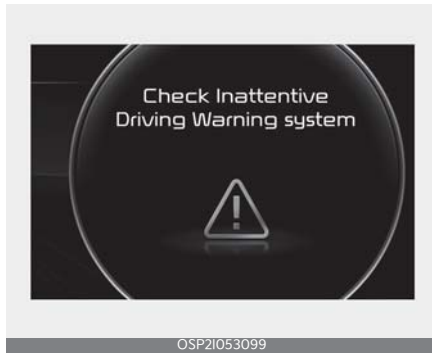

When Driver Attention Warning is not working properly, a driver attention warning light (⚠), a warning message will appear on the cluster for several seconds, and the master warning light (⚠) will appear on the cluster. If this occurs, have the vehicle checked by a professional workshop. Kia recommends to

visit an authorized Kia dealer/service partner.

**Driver Attention Warning disabled**

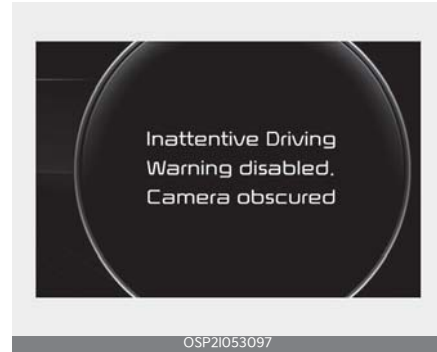

When the front view camera is located is covered with foreign material, such as snow or rain, it can reduce the detecting performance and temporarily limit or disable Driver Attention Warning.

If this occurs, the warning message, the master warning light (⚠) and the driver attention warning light (⚠) will appear on the cluster. However, it is not a malfunction. Driver Attention Warning will operate properly when driving after snow, rain or foreign material is removed. Always keep it clean.

If Driver Attention Warning does not operate normally after obstruction (snow, rain, or foreign material) is removed, have the vehicle checked by a professional workshop. Kia recommends to visit an authorized Kia dealer/service partner.

**⚠ WARNING**

- Driver Attention Warning may not work properly in areas where substances are not detected after turning ON the vehicle (e.g. in open terrain) or

6

if the recognition sensor is contaminated.

- Even if restarting the vehicle with the sensors blocked or malfunctioned, Driver Attention Warning may not properly operate as the function maintains the last setting.

### Limitations of Driver Attention Warning

Driver Attention Warning may not work properly in the following situations:

- The vehicle is driven violently
- The vehicle intentionally crosses over lanes frequently
- The vehicle is controlled by Driver Assistance system, such as Lane Keeping Assist.

### Leading Vehicle Departure Alert

- When the vehicle cuts in

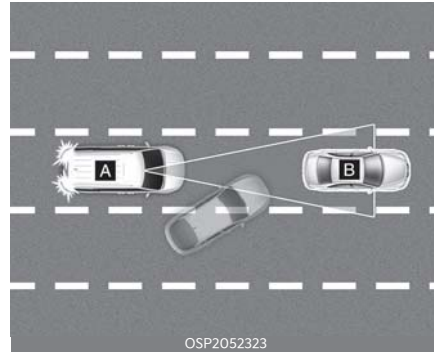
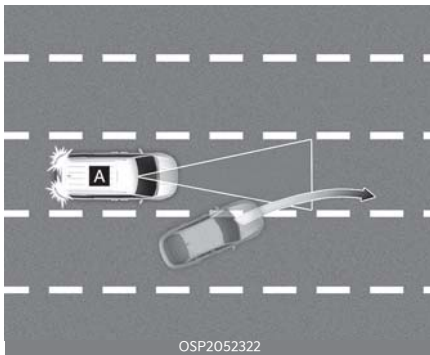

[A]: Your vehicle, [B]: Front vehicle

If a vehicle cuts in front of your vehicle, Leading Vehicle Departure Alert may not operate properly.

- When the vehicle ahead sharply steers

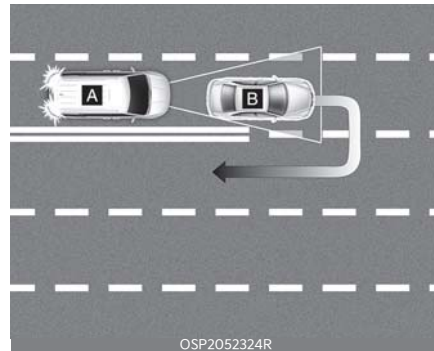

[A]: Your vehicle, [B]: Front vehicle

If the vehicle in front makes a sharp turn, such as to turn left or right or make a U-turn, etc., Leading Vehicle Departure Alert may not operate properly.

## Driver assistance system

- When the vehicle ahead abruptly departs

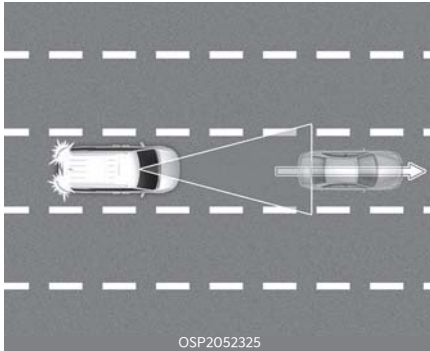

If the vehicle in front abruptly departs, Leading Vehicle Departure Alert may not operate properly.

- When a pedestrian or cyclist is between you and the vehicle ahead



If there is a pedestrian or cyclist in between you and the vehicle in front, Leading Vehicle Departure Alert may not operate properly.

## Driver Attention Warning (DAW)

- When in a parking lot

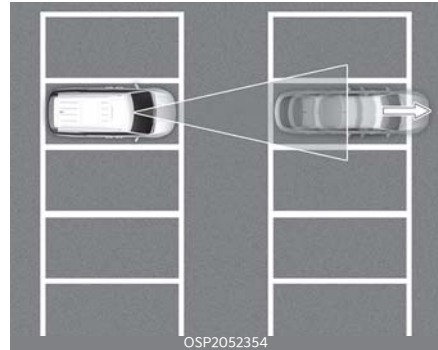

If a vehicle parked in front drives away from you, Leading Vehicle Departure Alert may warn you that the parked vehicle is driving away.

- When driving at a tollgate or intersection, etc.

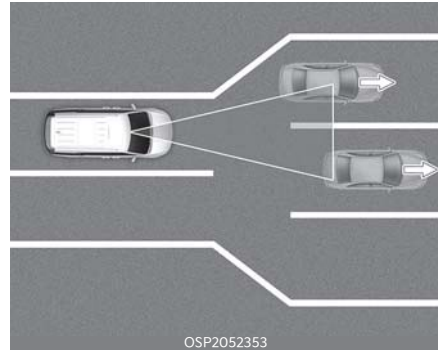

If you pass a tollgate or intersection with lots of vehicles or you drive where lanes are merged or divided frequently, Leading Vehicle Departure Alert may not operate properly.

### **⚠ WARNING**

Driver Attention Warning may not operate for 15 seconds after the vehicle is started, or the front view camera is initialized.



**\* NOTICE**

For more details on the precautions of the front view camera, refer to "Forward Collision-Avoidance Assist (FCA) (Sensor fusion) (if equipped)" on page 6-4.

**Blind-Spot View Monitor (BVM) (if equipped)**

Left side



Right side



Blind-Spot View Monitor displays the rear blind spot area of the vehicle in the cluster when the turn signal is turned on to help safely change lanes.

## Detecting sensor

Wide-side view camera



(camera located at bottom of the mirror)  
Refer to the picture above for the detailed location of the detecting sensors.

## Blind-Spot View Monitor settings

### Blind-Spot View

With the vehicle on, select **Driver assistance** → **Blind-spot safety** → **Blind-spot view** from the Settings menu to turn on Blind-Spot View Monitor and deselect to turn off the function.

### Blind-Spot View Monitor operation

#### Turn signal switch

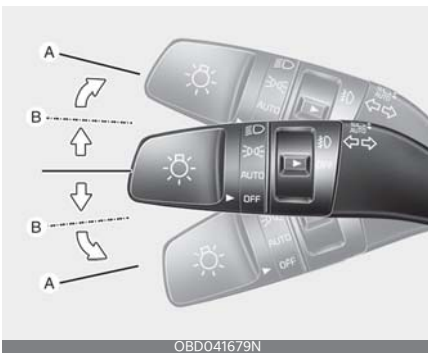

Blind-Spot View Monitor will turn on and off when the turn signal is turned on and off.

## Blind-Spot View Monitor

### Operating conditions

- When the left or right turn signal turns on, the image on the instrument cluster will turn on.

### Off conditions

Blind-Spot View Monitor will turn off when one of the following conditions are satisfied:

- When the turn signal is turned off.
- When the hazard warning flasher is on.
- When other important warning is displayed on the instrument cluster.

### Blind-Spot View Monitor malfunction

When Blind-Spot View Monitor is not working properly, or the cluster display flickers, or the camera image does not display normally, have the vehicle checked by a professional workshop. Kia recommends to visit an authorized Kia dealer/service partner.

### ⚠ WARNING

- The image shown on the cluster may differ from the actual distance of the object. Make sure to directly check the vehicle's surroundings for safety.
- If the camera lens is covered with foreign material, Blind-Spot View Monitor may not operate normally. Always keep the camera lens clean. However, do not use chemical solvents such as strong detergents containing high alkaline or volatile



organic solvents (gasoline, acetone etc.). This may damage the camera lens.

## Cruise Control (CC) (if equipped)



1. Cruise indicator
2. Set speed

Cruise Control will allow you to drive at speeds above 30 km/h (20 mph) without depressing the accelerator pedal.

### Cruise Control operation

#### Setting set speed

1. Accelerate to the desired speed, which must be more than 30 km/h (20 mph).



2. Press the Driving Assist button at the desired speed. The set speed and Cruise (CRUISE) indicator will illuminate on the cluster.
3. Release the accelerator pedal.

Vehicle speed will maintain the set speed even when the accelerator pedal is not depressed.

#### \* NOTICE

- The vehicle may slightly slow down or speed up while driving uphill or downhill.
- The Driving Assist button symbol may vary depending on your vehicle option.

### Increasing set speed

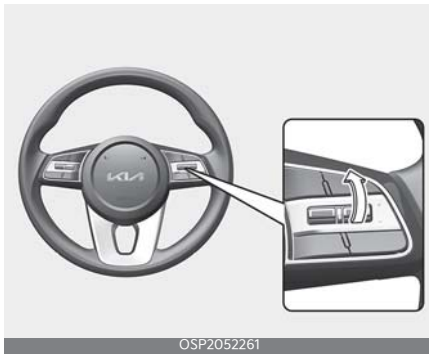

OSP2052261

- Push the + switch up and release it immediately. The set speed will increase by 1 km/h (1 mph) each time the switch is operated in this manner.
- Push the + switch up and hold it whilst monitoring the set speed on the cluster. The set speed will increase to the nearest multiple of ten (multiple of five in mph) at first, and then increase by 10 km/h (5 mph) each time the switch is operated in this manner. Release the switch when the desired speed is shown and the vehicle will accelerate to that speed.

### Decreasing set speed

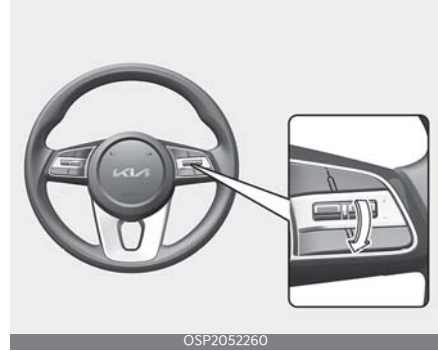

OSP2052260

- Push the - switch down and release it immediately. The set speed will decrease by 1 km/h (1 mph) each time the switch is operated in this manner.
- Push the - switch down and hold it whilst monitoring the set speed on the cluster. The set speed will decrease to the nearest multiple of ten (multiple of five in mph) at first, and then decrease by 10 km/h (5 mph) each time the switch is operated in this manner.

Release the switch at the speed you want to maintain.

### Accelerating temporarily

If you want to speed up temporarily when Cruise Control is on, depress the accelerator pedal.

To return to the set speed, take your foot off the accelerator pedal.

If you push the (+) switch up or (-) switch down at increased speed, the set speed will be set to the current increased speed.

## Temporarily pausing Cruise Control



Cruise Control will be paused when:

- Depressing the brake pedal.
- Pressing the button.
- Shifting the gear to N (Neutral).
- Decreasing vehicle speed to less than 30 km/h (20 mph).
- ESC (Electronic Stability Control) is operating.
- The vehicle speed is above 180 km/h (110 mph).

The set speed will turn off but the Cruise (CRUISE) indicator will stay on.

### \* NOTICE

If Cruise Control pauses during a situation that is not mentioned, have the vehicle checked by a professional workshop. Kia recommends to visit an authorized Kia dealer/service partner.

## Resuming Cruise Control



Operate the +, - switch or .

If you push the + switch up or - switch down, vehicle speed will be set to the current speed on the cluster.

If you press the button, vehicle speed will resume to the preset speed. Vehicle speed must be above 30 km/h (20 mph) for the function to resume.

### ⚠ WARNING

Check the driving condition before using the switch. Driving speed may sharply increase or decrease when you press the switch.

## Turning off Cruise Control

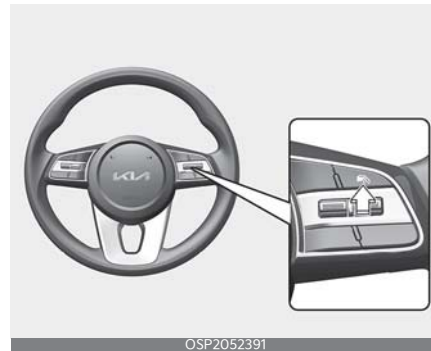

Press the Driving Assist button to turn Cruise Control off. The Cruise indicator will go off.

Always press the Driving Assist button to turn Cruise Control off when not in use.

### \* NOTICE

If your vehicle is equipped with Manual Speed Limit Assist, press and hold the Driving Assist button to turn off Cruise Control. However, Manual Speed Limit Assist will turn on.

### ▲ WARNING

Take the following precautions when using Cruise Control:

- Always set the vehicle speed under the speed limit in your country.
- Keep Cruise Control off when the function is not in use, to avoid inadvertently setting a speed. Check that the Cruise (CRUISE) indicator is off.
- Cruise Control does not substitute for proper and safe driving. It is the responsibility of the driver to always drive safely and should always be aware of unexpected and sudden situations from occurring.
- Always drive cautiously to prevent unexpected and sudden situations from occurring. Pay attention to the road conditions at all times.
- Do not use Cruise Control when it may be unsafe to keep the vehicle at a constant speed:
  - When driving in heavy traffic, or when traffic conditions make it difficult to drive at a constant speed
  - When driving on rainy, icy, or snow-covered roads

- When driving on hilly or windy roads
- When driving in windy areas
- When driving with limited view (possibly due to bad weather, such as fog, snow, rain and sandstorm)
- Do not use Cruise Control when towing a trailer.

## Smart Cruise Control (SCC) (if equipped)

### Basic function

Smart Cruise Control allows you to program the vehicle to maintain constant speed and distance detecting the vehicle ahead without depressing the accelerator or brake pedal.

### Overtaking Acceleration Assist

If the driver attempts to overtake, the vehicle will accelerate to assist overtaking.

### Detecting sensor

[1]: Front view camera



[2]: Front radar



The front view camera and front radar are used as a detecting sensor to detect

vehicles in front. Refer to the picture for the detailed location of the detecting sensor.

### CAUTION

- Always keep the front view camera and front radar in good condition to maintain optimal performance of Smart Cruise Control.
- For more details on the precautions of the front view camera and front radar, refer to "Forward Collision-Avoidance Assist (FCA) (Sensor fusion) (if equipped)" on page 6-4.

## Smart Cruise Control settings

### Smart Cruise Control

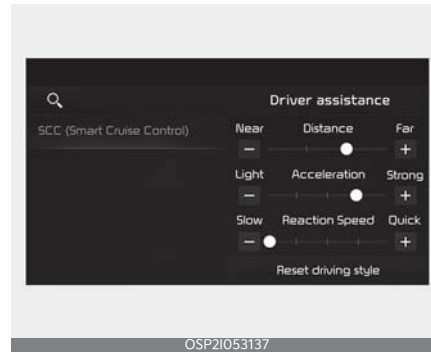

With the vehicle on, select **User settings** → **Driver assistance** → **Smart Cruise Control** on the LCD display or select **Settings** → **Vehicle** → **Driver assistance** → **Driving convenience** → **Smart Cruise Control** on the infotainment system to set the distance, acceleration and the reaction speed.

## Warning methods



You can adjust the Warning methods with ENGINE START/STOP button in the ON position.

- **Warning volume :** Select 'User settings → Driver assistance → Warning volume' on the LCD display or 'Settings → Vehicle → Driver assistance → Warning methods' on the Infotainment system.
- **Driving safety priority :** Select 'Settings → Vehicle → Driver assistance → Warning methods → Driving safety priority' on the Infotainment system. For safe driving, the audio volume will temporarily decrease to warn the driver with the audible warning.

### \* NOTICE

- Ensure that Warning methods you have set may apply to the warning volume of other Driver Assistance systems.
- Warning methods will maintain its last setting even if the vehicle is restarted.
- The setting menu may not be available for your vehicle depending on the vehicle features and specifications.

## Smart Cruise Control operation

### Operating conditions for basic function

#### Basic function

Smart Cruise Control operates when the following conditions are satisfied.

- The gear is in D (Drive)
- Your driving speed is within the operating speed range
  - 10~180km/h (5~112mph): when there is no vehicle in front
  - 0~180km/h (0~112mph): when there is a vehicle in front
- ESC (Electronic Stability Control) or ABS is on

Smart Cruise Control does not operate in the following conditions.

- The driver's door is opened
- Engine RPM is high
- EPB (Electronic Parking Brake) is applied
- ESC (Electronic Stability Control) or ABS is controlling the vehicle
- Forward Collision-Avoidance Assist brake control is operating
- Entering ISG Condition



**\* NOTICE**

When stopped behind another vehicle, the driver can turn on Smart Cruise Control whilst the brake pedal is depressed.

**Overtaking Acceleration Assist**

Overtaking Acceleration Assist will operate when the turn signal indicator is turned on to the left (left-hand drive) or turned on to the right (right-hand drive) whilst Smart Cruise Control is operating, and the following conditions are satisfied:

- Your driving speed is above 60 km/h (40 mph)
- A vehicle is detected in front of your vehicle

Overtaking Acceleration Assist does not operate in the following conditions.

- The hazard warning flasher is on
- Vehicle speed is reduced to maintain distance with the vehicle in front

**⚠ WARNING**

- When the turn signal indicator is turned on to the left (left-hand drive) or turned on to the right (right-hand drive) whilst there is a vehicle ahead, the vehicle may accelerate temporarily. Pay attention to the road conditions at all times.
- Regardless of your country's driving direction, Overtaking Acceleration Assist will operate when the conditions are satisfied. When using the function in countries with different driving direction, always check the road conditions at all times.

**Turning on Smart Cruise Control**

Press the Driving Assist button to turn on Smart Cruise Control. The speed will be set to the current speed on the cluster.

- If there is no vehicle in front of you, the set speed will be maintained.
- If there is a vehicle in front of you, the speed may decrease to maintain the distance to the vehicle ahead. If the vehicle ahead accelerates, your vehicle will travel at a steady cruising speed after accelerating to the set speed.

**\* NOTICE**

If your vehicle speed is between 0~30 km/h (0~20 mph) when you press the Driving Assist button, the set speed will be set to 30 km/h (20 mph).

## Setting Vehicle Distance

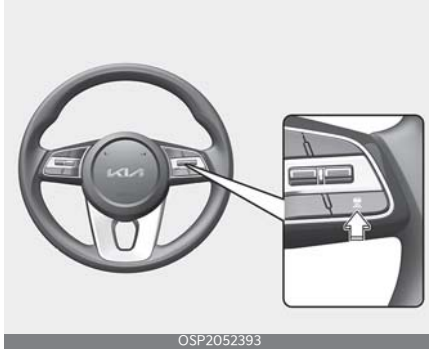

Each time the Vehicle Distance button is pressed, the Vehicle Distance changes as follows:

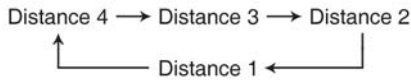

### \* NOTICE

- If you drive at 90 km/h (56 mph), the distance is maintained as follows:
  - Distance 4 - approximately 52.5 m (172 ft.)
  - Distance 3 - approximately 40 m (130 ft.)
  - Distance 2 - approximately 32.5 m (106 ft.)
  - Distance 1 - approximately 25 m (82 ft.)
- The distance is set to the last set distance when the engine is restarted, or when Smart Cruise Control was temporarily cancelled.

## Increasing set speed



- Push up the + switch, and release it immediately. The set speed will increase by 1 km/h (1 mph) each time the switch is operated in this manner.
- Push up the + switch, and hold it whilst monitoring the set speed on the cluster. The set speed will increase by 10 km/h or 5 mph each time the switch is operated in this manner. You can increase the set speed to 180km/h (112mph).

### ⚠ WARNING

Check the driving condition before using the + switch. Driving speed may sharply increase when you push up and hold the + switch.

## Decreasing set speed



OSP2052395

- Push the (-) switch down and release it immediately. The set speed will decrease by 1 km/h (1 mph) each time the switch is operated in this manner.
- Push the (-) switch down and hold it. The set speed will decrease by 10 km/h (5 mph) each time the switch is operated in this manner.

You can decrease the set speed to 30 km/h (20 mph).

## Temporarily canceling Smart Cruise Control



OSP2052396

Press the || ⏸ switch or depress the brake pedal to temporarily cancel Smart Cruise Control.

## Resuming Smart Cruise Control

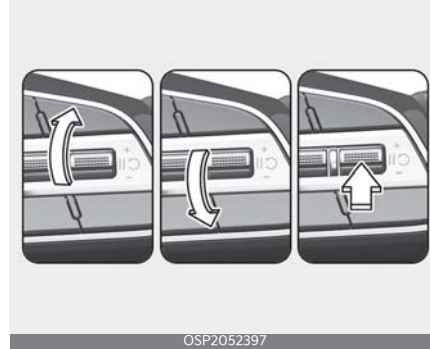

OSP2052397

To resume Smart Cruise Control after the function was cancelled, operate the +, - or || ⏸ switch.

If you push the + switch up or - switch down, the set speed will be set to the current speed on the cluster.

If you press the || ⏸ switch, vehicle speed will resume to the preset speed.

### ⚠ WARNING

Check the driving condition before press the || ⏸ switch. Driving speed may sharply increase or decrease when you press the || ⏸ switch.

## Turning off Smart Cruise Control



OSP2052391

Press the Driving Assist button to turn Smart Cruise Control off.

**\* NOTICE**

If your vehicle is equipped with Manual Speed Limit Assist, press and hold the Driving Assist button to turn off Smart Cruise Control. However Manual Speed Limit Assist will turn on.

**⚠ CAUTION**

Do not use the switches and buttons at the same time. Smart Cruise Control may not operate properly.

**Displaying operating status**

You can see the status of Smart Cruise Control operation in the Driving Assist view on the cluster. Refer to "Instrument cluster" on page 4-41.

Operating

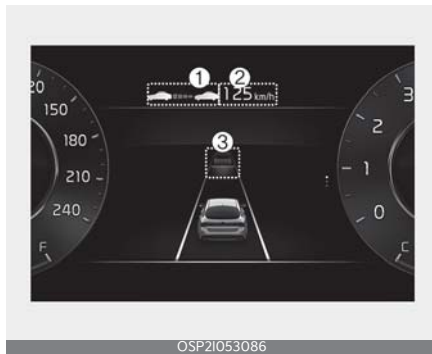

Temporarily cancelled



Smart Cruise Control will be displayed as below depending on the status of the function.

- When operating
  1. Whether there is a vehicle ahead and the selected distance level
  2. Set speed
  3. Whether there is a vehicle ahead and the target vehicle distance
- When temporarily cancelled
  1. Vehicle (gray)
  2. Previous set speed (gray)

**Accelerating temporarily**

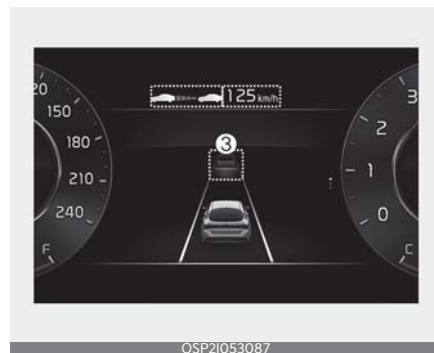

If you want to speed up temporarily without altering the set speed while Smart Cruise Control is operating,

depress the accelerator pedal. While the accelerator pedal is depressed, the set speed, distance level and target distance will blink on the cluster.

However, if the accelerator pedal is depressed insufficiently, the vehicle may decelerate.

### ▲ WARNING

Be careful when accelerating temporarily, because the speed is not controlled automatically even if there is a vehicle in front of you.

## Temporarily canceling Smart Cruise Control

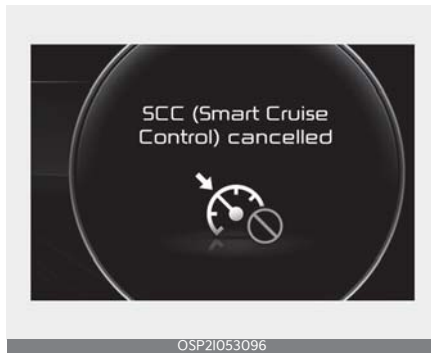

Smart Cruise Control will be temporarily canceled automatically when:

- Your driving speed is above 190km/h (118mph)
- The vehicle is stopped for a certain period of time
- The accelerator pedal is continuously depressed for a certain period of time
- The conditions for the Smart Cruise Control to operate is not satisfied

If Smart Cruise Control is temporarily canceled automatically, the warning message will appear on the cluster, and

an audible warning will sound to warn the driver.

### \* NOTICE

If Smart Cruise Control is temporarily cancelled whilst the vehicle is at a standstill with the function operating, EPB (Electronic Parking Brake) may be applied.

### ▲ WARNING

When Smart Cruise Control is temporarily cancelled, distance with the front vehicle will not be maintained. Always have your eyes on the road whilst driving, and if necessary, depress the brake pedal to reduce your driving speed in order to maintain a safe distance.

## Smart Cruise Control conditions not satisfied

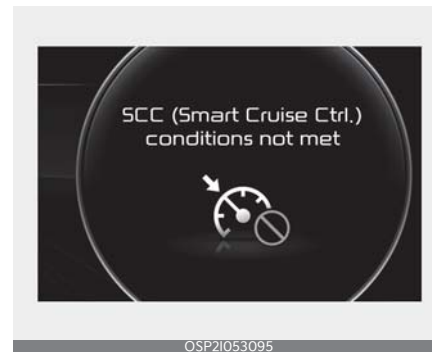

If the Driving Assist button, +, - or || with a circular arrow icon switch is operated when Smart Cruise Control's operating conditions are not satisfied, the warning message will appear on the cluster, and an audible warning will sound.

## In traffic situation

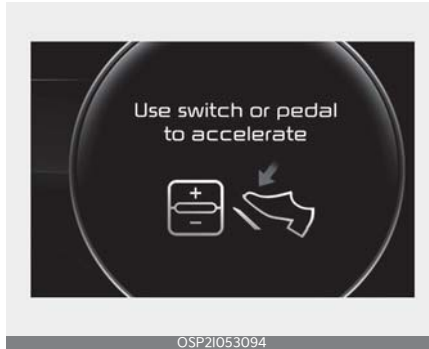

In traffic, your vehicle will stop if the vehicle ahead of you stops. Also, if the vehicle ahead of you starts moving, your vehicle will start as well. In addition, after the vehicle has stopped and a certain time has passed, the warning message will appear on the cluster. Depress the accelerator pedal or operate the + switch, - switch or switch to start driving.

## Warning road conditions ahead

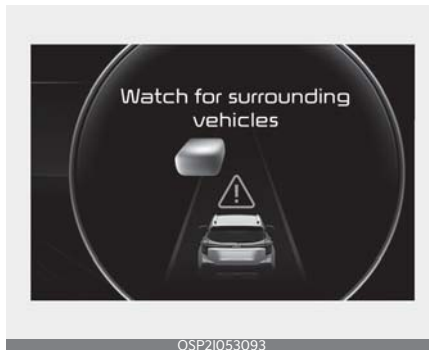

In the following situation, the warning message will appear on the cluster, and an audible warning will sound to warn the driver of road conditions ahead.

## ⚠ WARNING

Always pay attention to vehicles or objects that may suddenly appear in front of you, and if necessary, depress the brake pedal to reduce your driving speed in order to maintain a safe distance.

## Collision warning



Whilst Smart Cruise Control is operating, when the collision risk with the vehicle ahead is high, the warning message will appear on the cluster, and an audible warning will sound to warn the driver. Always have your eyes on the road whilst driving, and if necessary, depress the brake pedal to reduce your driving speed in order to maintain a safe distance.

## ⚠ WARNING

- In the following situations, Smart Cruise Control may not warn the driver of a collision.
  - The distance from the front vehicle is near, or the vehicle speed of the other vehicle is faster or similar with your vehicle
  - The speed of the front vehicle is very slow or is at a standstill

- The accelerator pedal is depressed right after Smart Cruise Control is turned on

**⚠ WARNING**

- Smart Cruise Control does not substitute for proper and safe driving. It is the responsibility of the driver to always check the speed and distance to the vehicle ahead.
- Smart Cruise Control may not recognize unexpected and sudden situations or complex driving situations, so always pay attention to driving conditions and control your vehicle speed.
- Keep Smart Cruise Control off when the function is not in use to avoid inadvertently setting a speed.
- Do not open the door or leave the vehicle when Smart Cruise Control is operating, even if the vehicle is stopped.
- Always be aware of the selected speed and vehicle distance.
- When towing a trailer or another vehicle, Smart Cruise Control performance may decrease or your vehicle may operate at a high RPM or experience frequent gear changes, so always drive with care.
- Keep a safe distance according to road conditions and vehicle speed. If the vehicle distance is too close during high-speed driving, a serious collision may result.
- When maintaining distance with the vehicle ahead, if the front vehicle disappears, Smart Cruise Control may suddenly accelerate to the set speed. Always be aware of unexpected and sudden situations from occurring.
- Vehicle speed may decrease on an upward slope and increase on a downward slope.
- Always be aware of situations such as when a vehicle cuts in suddenly.
- When you are towing a trailer or another vehicle, we recommend that Smart Cruise Control is turned off due to safety reasons.
- Turn off Smart Cruise Control when your vehicle is being towed.
- Smart Cruise Control may not operate properly if interfered with by strong electromagnetic waves.
- Smart Cruise Control may not detect an obstacle in front and lead to a collision. Always look ahead cautiously to prevent unexpected and sudden situations from occurring.
- Vehicles moving in front of you with a frequent lane change may cause a delay in Smart Cruise Control's reaction or may cause Smart Cruise Control to react to a vehicle actually in an adjacent lane. Always drive cautiously to prevent unexpected and sudden situations from occurring.
- Always be aware of the surroundings and drive safely, even though a warning message does not appear or an audible warning does not sound.
- If any other function's warning message is displayed or warning sound is generated, Smart Cruise Control warning message may not be displayed and warning sound may not be generated.
- You may not hear the warning sound of Forward Collision-Avoidance Assist if the surrounding is noisy.
- The vehicle manufacturer is not responsible for any traffic violation or accidents caused by the driver.

- Always set the vehicle speed under the speed limit in your state.

**\* NOTICE**

- Smart Cruise Control may not operate in few seconds after the vehicle is started or the front view camera or front radar is initialized.
- You may hear a sound when the brake is controlled by Smart Cruise Control.

**Smart Cruise Control malfunction and limitations**

**Smart Cruise Control malfunction**

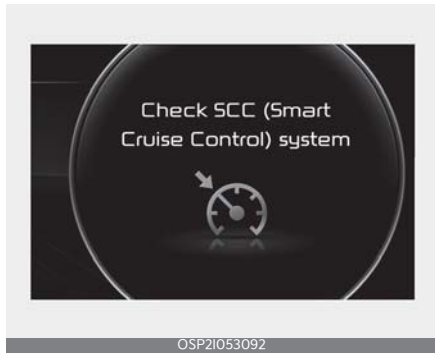

When Smart Cruise Control is not working properly, the warning message will appear for several seconds and the  warning light will appear on the cluster. In this case, have the function checked by a professional workshop. Kia recommends to visit an authorised Kia dealer/ service partner.

**Smart Cruise Control disabled**



When the front radar cover or sensor is covered with snow, rain, or foreign matters, it can reduce the detecting performance and temporarily limit or disable Smart Cruise Control.

If this occurs, the warning message will appear for a certain period of time on the cluster.

Smart Cruise Control will operate properly when such snow, rain or foreign matter is removed. Always keep it clean.

**⚠ WARNING**

Even though the warning message does not appear on the cluster, Smart Cruise Control may not properly operate.

**⚠ CAUTION**

Smart Cruise Control may not properly operate in an area (for example, open terrain), where any objects are not detected after turning ON the engine.

**Limitations of Smart Cruise Control**

Smart Cruise Control may not operate properly or it may operate unexpectedly under the following circumstances:



## Driver assistance system

## Smart Cruise Control (SCC)

- The detecting sensor or the surroundings are contaminated or damaged
- Washer fluid is continuously sprayed, or the wiper is on
- The camera lens is contaminated due to tinted, filmed or coated windscreen, damaged glass, or stuck of foreign matters (sticker, bug, etc.) on the glass
- Moisture is not removed or frozen on the windscreen
- The field of view of the front view camera is obstructed by sun glare
- Street light or light from an oncoming vehicle is reflected on the wet road surface, such as a puddle in the road
- The temperature around the front view camera is high or low
- An object is placed on the dashboard
- The surrounding is very bright
- The surrounding is very dark, such as in a tunnel, etc.
- The brightness changes suddenly, for example when entering or exiting a tunnel
- The brightness outside is low, and the headlamps are not on or are not bright
- Driving in heavy rain or snow, or thick fog
- Driving through steam, smoke or shadow
- Only part of the vehicle is detected
- The vehicle in front has no tail lights, tail lights are located unusually, etc.
- The brightness outside is low, and the tail lamps are not on or are not bright
- The rear of the front vehicle is small or does not look normal (for example, tilted, overturned, etc.)
- The front vehicle's ground clearance is low or high
- Your vehicle is being towed
- A vehicle suddenly cuts in front
- Driving through a tunnel or railroad bridge
- An object reflecting off the front radar such as a guardrail, nearby vehicle, etc.
- The bumper around the front radar is impacted, damaged or the front radar is out of position
- The temperature around the front radar is high or low
- Driving in vast areas where there are few vehicles or structures (for example, desert, meadow, suburb, etc.)
- The vehicle in front is made of material that does not reflect on the front radar
- Driving near a highway (or motorway) interchange or tollgate
- Driving on a slippery surface due to snow, water puddle, ice, etc.
- Driving on a curved road
- The vehicle in front is detected late
- The vehicle in front is suddenly blocked by an obstacle
- The vehicle in front suddenly changes lane or suddenly reduces speed
- The vehicle in front is bent out of shape
- The front vehicle's speed is fast or slow
- With a vehicle in front, your vehicle changes lane at low speed
- The vehicle in front is covered with snow
- You are driving unstably
- You are on a roundabout and the vehicle in front is not detected

- You are continuously driving in a circle
- Driving in a parking lot
- Driving through a construction area, unpaved road, partial paved road, uneven road, speed bumps, etc.
- Driving on an incline road, curved road, etc.
- Driving through a roadside with trees or streetlights
- The adverse road conditions cause excessive vehicle vibrations whilst driving
- Your vehicle height is low or high due to heavy loads, abnormal tyre pressure, etc.
- Driving through a narrow road where trees or grass are overgrown
- There is interference by electromagnetic waves, such as driving in an area with strong radio waves or electrical noise
- **Driving on a curved road**

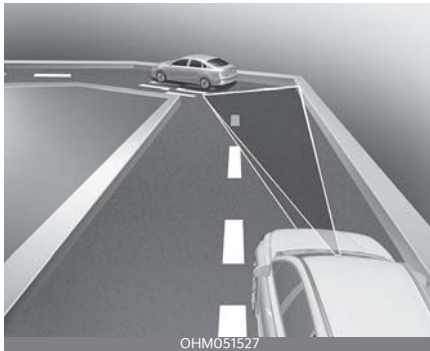

On curves, Smart Cruise Control may not detect a vehicle in the same lane, and may accelerate to the set speed. Also, vehicle speed may rapidly decrease when the vehicle ahead is detected suddenly.

Select the appropriate set speed on curves and apply the brake pedal or accelerator pedal according to the road and driving conditions ahead.

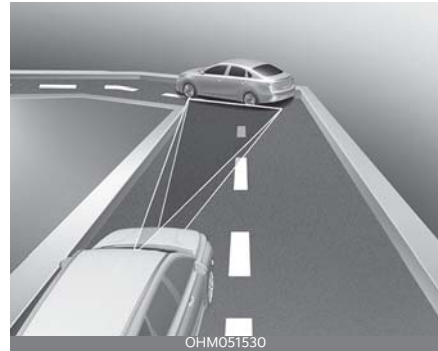

Your vehicle speed can be reduced due to a vehicle in the adjacent lane.

Apply the accelerator pedal and select the appropriate set speed. Check to be sure that the road conditions permit safe operation of Smart Cruise Control.

- **Driving on an inclined road**



During uphill or downhill driving, Smart Cruise Control may not detect a moving vehicle in your lane, and cause your vehicle to accelerate to the set speed. Also, vehicle speed will rapidly decrease when the vehicle ahead is detected suddenly.

Select the appropriate set speed on inclines and apply the brake pedal or accelerator pedal according to the road and driving conditions ahead.

- **Changing lanes**

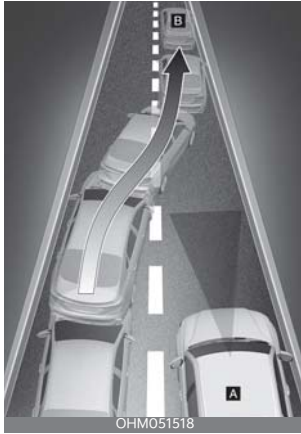

[A]: Your vehicle, [B]: Lane changing vehicle

When a vehicle moves into your lane from an adjacent lane, it cannot be detected by the sensor until it is in the sensor's detection range.

Smart Cruise Control may not immediately detect the vehicle when the vehicle changes lanes abruptly. In this case, you must maintain a safe braking distance, and if necessary, depress the brake pedal to reduce your driving speed in order to maintain a safe distance.

- **Situations when detecting are limited**

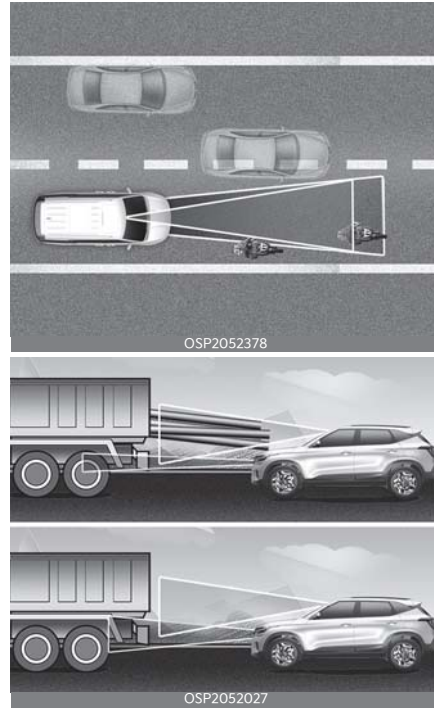

In the following cases, some vehicles in your lane cannot be detected by the sensor:

- Vehicles offset to one side
- Slow-moving vehicles or sudden-decelerating vehicles
- Oncoming vehicles
- Stopped vehicles
- Vehicles with small rear profile, such as trailers
- Narrow vehicles, such as bicycles
- Special vehicles
- Animals and pedestrians

In the following cases, the vehicle in front cannot be detected by the sensor:

- Vehicles with higher clearance or vehicles carrying loads that stick out of the back of the vehicle

## Driver assistance system

- Vehicles that have the front lifted due to heavy loads
- You are steering your vehicle
- Driving on narrow or sharply curved roads

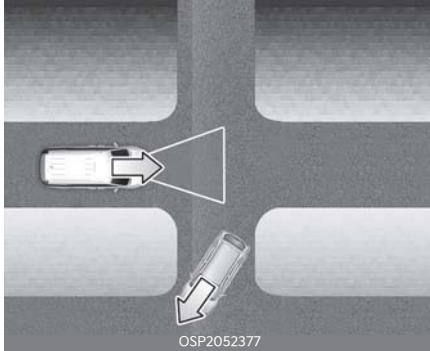

When a vehicle ahead disappears at an intersection, your vehicle may accelerate. Always pay attention to road and driving conditions whilst driving.

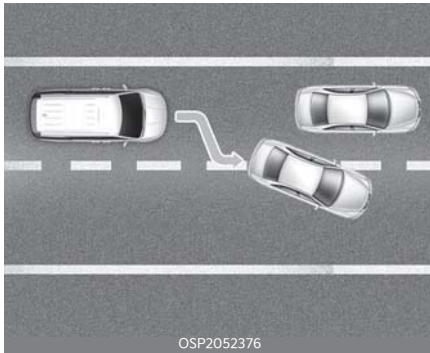

When a vehicle in front of you merges out of the lane, Smart Cruise Control may not immediately detect the new vehicle that is now in front of you. Always pay attention to road and driving conditions whilst driving.

## Smart Cruise Control (SCC)

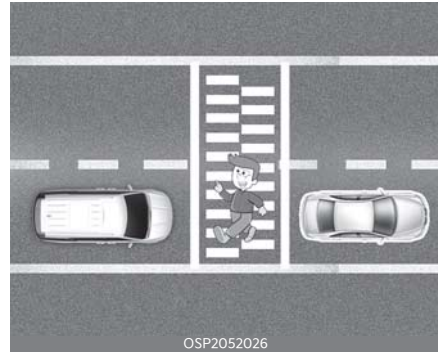

Always look out for pedestrian when your vehicle is maintaining a distance with the vehicle ahead.

## Lane Following Assist (LFA) (if equipped)

Lane Following Assist is designed to detect lane markings or vehicles on the road, and assists the driver's steering to help centre the vehicle in the lane.

### Detecting sensor

[1]: Front view camera



The front view camera is used as a detecting sensor to detect lane markings and front vehicles. Refer to the picture above for the detailed location of the detecting sensor.

### **CAUTION**

For more details on the precautions of the front view camera, refer to "Forward Collision-Avoidance Assist (FCA) (Sensor fusion) (if equipped)" on page 6-4.

## Lane Following Assist settings

### Warning methods



OSP2I053079

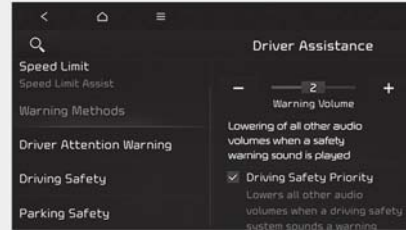

OSP2I063037

You can adjust the Warning methods with ENGINE START/STOP button in the ON position.

- Warning volume : Select 'User settings → Driver assistance → Warning volume' on the LCD display or 'Settings → Vehicle → Driver assistance → Warning methods' on the Infotainment system.
- Driving safety priority : Select 'Settings → Vehicle → Driver assistance → Warning methods → Driving safety priority' on the Infotainment system. For safe driving, the audio volume will temporarily decrease to warn the driver with the audible warning.

### \* NOTICE

- Ensure that Warning methods you have set may apply to the warning volume of other Driver Assistance systems.
- Warning methods will maintain its last setting even if the vehicle is restarted.
- The setting menu may not be available for your vehicle depending on the vehicle features and specifications.

## Lane Following Assist operation

### Turning Lane Following Assist ON/OFF

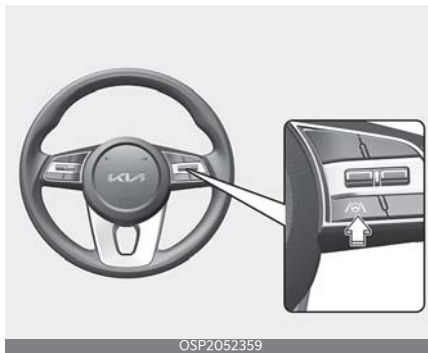

OSP2052359

With ENGINE START/STOP button in the ON position, press the Lane Driving Assist button located on the steering wheel to turn on Lane Following Assist. The white or green (🚗) indicator light will illuminate on the cluster. Press the Lane Driving Assist button again to turn off the function.

## Warning and control

### Lane Following Assist

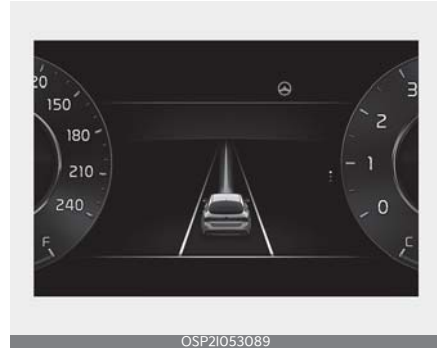

OSP21053089

If the vehicle ahead or both lane markings are detected and your vehicle speed is below 180 km/h (110 mph), the green (🚗) indicator light will illuminate on the cluster, and the function will help centre the vehicle in the lane by controlling the steering wheel.

### ⚠ CAUTION

When the steering wheel is not controlled, the green (🚗) indicator light will blink and change to white.

### Hands-off warning

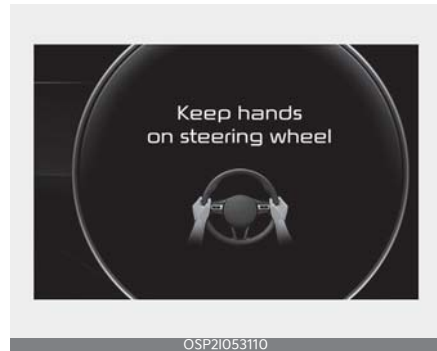

OSP21053110

If the driver takes their hands off the steering wheel for several seconds, the warning message will appear and an audible warning will sound in stages.

- First stage: Warning message
- Second stage: Warning message (red steering wheel) and audible warning

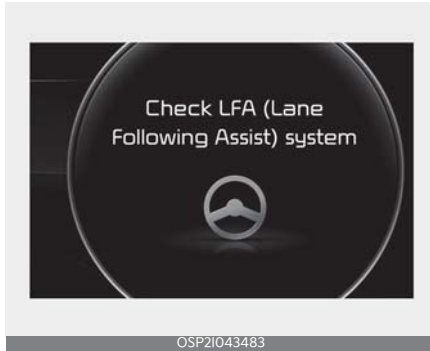

If the driver still does not have their hands on the steering wheel after the hands-off warning, the warning message will appear and Lane Following Assist will be automatically cancelled.

#### ⚠ WARNING

- The steering wheel may not be assisted if the steering wheel is held very tight or the steering wheel is steered over a certain degree.
- Lane Following Assist does not operate at all times. It is the responsibility of the driver to safely steer the vehicle and to maintain the vehicle in its lane.
- The hands-off warning message may appear late depending on road conditions. Always have your hands on the steering wheel whilst driving.
- If the steering wheel is held very lightly the hands-off warning message may appear because the function may not recognize that the driver has their hands on the steering wheel.

- If you attach objects to the steering wheel, the hands-off warning may not work properly.

#### \* NOTICE

- For more details on setting the functions in the infotainment system, refer to "LCD display" on page 4-49.
- When both lane markings are detected, the lane lines on the cluster will change from gray to white.

Lane undetected



Lane detected

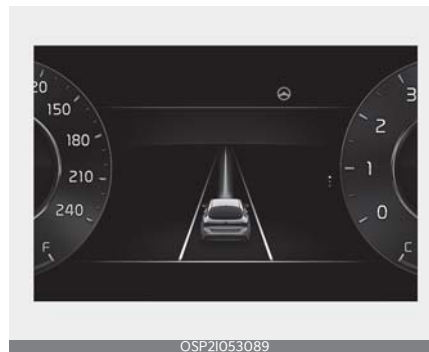

- The images and colours in the instrument cluster may differ depending on the cluster type or theme selected from the settings menu.

- If lane markings are not detected, steering wheel control by Lane Following Assist can be limited depending on whether a vehicle is in front or the driving conditions of the vehicle.
- Even though the steering is assisted by Lane Following Assist, the driver may control the steering wheel.
- The steering wheel may feel heavier or lighter when the steering wheel is assisted by Lane Following Assist than when it is not.

### Limitations of Lane Following Assist

For more details on system limitations, refer to "Limitations of Lane Keeping Assist" on page 6-22.

### Lane Following Assist malfunction and limitations

#### Lane Following Assist malfunction

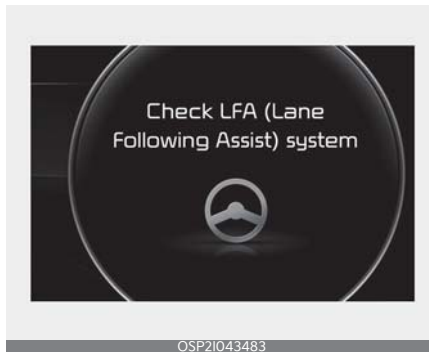

When Lane Following Assist is not working properly, the warning message will appear for several seconds and (⚠️) warning light will appear on the cluster. In this case, have the vehicle checked by a professional workshop. Kia recommends to visit an authorized Kia dealer/service partner.



## Rear View Monitor (RVM) (if equipped)

Rear View Monitor will activate when the back-up light is ON with the ignition switch ON and the shift lever in the R (Reverse) position. Rear View Monitor is a supplemental function that shows behind the vehicle through Infotainment system whilst backing-up.

This description is about the operation of the RVM (Rear View Monitor) in vehicles equipped with navigation.

The settings and description may be different if Display Audio has equipped.

### Detecting sensor

[1]: Wide-rear view camera



Refer to the picture above for the detailed location of the detecting sensor.

## Rear View Monitor settings

### Warning methods

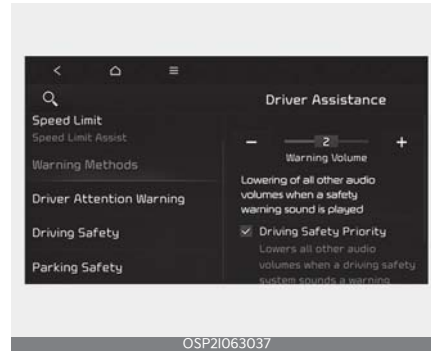

Warning methods can be set when the vehicle is in ON position.

- Parking safety priority: Select **Settings** → **Vehicle** → **Driver assistance** → **Warning methods** → **Parking safety priority** on the infotainment system. For safe parking, the audio volume will temporarily decrease while Rear View Monitor is operating.

### \* NOTICE

- Ensure that **Warning methods** you have set may apply to the **Warning methods** of other driver assistance systems.
- **Warning methods** will maintain its last setting even if the vehicle is restarted.
- The setting menu may not be available for your vehicle depending on the vehicle features and specifications.

### Camera settings



You can change Rear View Monitor 'Display contents' and 'Display settings' or by touching the setup icon (⚙️) on the screen whilst Rear View Monitor is operating, or selecting 'Settings → Vehicle → Driver assistance → Parking safety → Camera settings' from the Settings menu whilst the engine is on.

- Display contents: To change the settings of rear view with parking guidance, Extended Rear View Monitor.
- Display settings: To change the screen's brightness and contrast.

### Warning methods

You can adjust the Warning methods with ENGINE START/ STOP button in the ON position.

Parking safety priority : Select 'Settings → Vehicle → Driver assistance → Warning methods → Parking safety priority' on the Infotainment system for safe parking. The audio volume will temporarily decrease to warn the driver with the audible warning.

### \* NOTICE

- Ensure that Warning methods you have set may apply to the Warning

volume of other Driver assistance systems.

- Warning methods will maintain its last setting even if the vehicle is restarted.
- The settings menu may not be depending on the specifications of the vehicle specifications.

### Rear View Monitor operation

#### Parking/View button



Press the Parking/View button to turn on Rear View Monitor.

Press the button again to turn off the function.

#### Driving Rear View Monitor button



6

### Favorite Button setting: Driving Rear View Monitor

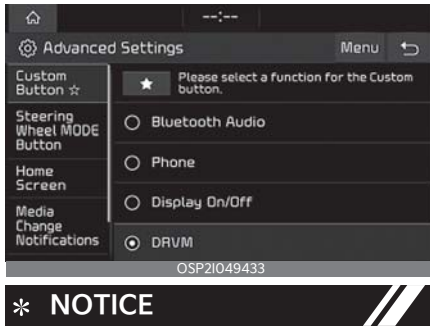

No guidelines will be shown when Driving Rear View Monitor is switched ON. Rear View has higher priority compared to Driving Rear View Monitor View.

Driving Rear View Monitor activates when:

- 8" display: Turn the ignition switch ON, press the Driving Rear View Monitor button (  ) in the display unit.

You can turn off Driving Rear View Monitor by doing one of the followings:

- Automatic Transmission/Intelligent Variable Transmission: Change the gear shift lever to "P" (Park).
- Manual Transmission/Intelligent Manual Transmission: Engage the parking brake.
- 8" display: Press the back button (  ) or any hard button in the display unit.

### Rear view



### Operating conditions

- Shift the gear to R (Reverse), the image will appear on the screen.
- Press the Parking/View button whilst the gear is in P (Park), the image will appear on the screen.
- Pressing the View icon with the Rear top view on the screen.

### Off conditions

- The rear view cannot be turned off when the gear is in R (Reverse).
- Press the Parking/View button again whilst the gear is in P (Park) with the rear view on the screen, the rear view will turn off.
- Shift the gear from R (Reverse) to P (Park), the rear view will turn off.

## Rear top view



When you touch the  icon, the top view is displayed on the screen and shows the distance from the vehicle in the back of your vehicle whilst parking.

## Extended Rear View Monitor

The rear view will maintain showing on the screen to help you when parking.

### Operating conditions

- Shift the gear from R (Reverse) to N (Neutral) or D (Drive), the rear view will appear on the screen.
- The vehicle speed is below approximately 10 km/h (6 mph).

### Off conditions

- When vehicle speed is above 10 km/h (6 mph), the rear view will turn off.
- Press the Parking/View button, the rear view will turn off.
- Shift the gear to P (Park), the rear view will turn off.

## Rear View whilst driving



The driver is able to check the rear view on the screen whilst driving, it is to assist with safe driving.

### Operating conditions

Press the Parking/View button whilst the gear is in D (Drive) or N (Neutral), the driving rear view will appear on the screen.

### Off conditions

- Press the Parking/View button again, the driving rear view will turn off.
- Press one of the infotainment system button, the driving rear view will turn off.
- Shift the gear to P (Park), the driving rear view will turn off.

### When operating

If the gear is shifted to R (Reverse), whilst Driving rear view is displayed on the screen, the screen will change to rear view with parking guidance.

## Rear View Monitor malfunction and limitations

### Rear View Monitor malfunction

When Rear View Monitor is not working properly, or the screen flickers, or the camera image does not display normally, we recommend that the vehicle be inspected by an authorised Kia dealer/service partner.

### Limitations of Rear View Monitor

When the vehicle is stopped for a long time in winter or when the vehicle is parked in an indoor parking lot, the exhaust fumes may temporarily blur the image.

#### **⚠ WARNING**

- The rear view camera does not cover the complete area behind the vehicle. The driver should always check the rear area directly through the inside and outside rearview mirror before parking or backing up.
- The image shown on the screen may differ from the actual distance of the object. Make sure to directly check the vehicle's surroundings for safety.
- Always keep the rear view camera lens clean. If the lens is covered with foreign material, it may adversely affect camera performance and Rear View Monitor may not operate normally. However, do not use chemical solvents such as strong detergents containing high alkaline or volatile organic solvents (petrol, acetone etc.). This may damage the camera lens.

## Surround View Monitor (SVM) (if equipped)

Surround View Monitor can assist in parking by allowing the driver to see around the vehicle.

### Detecting sensor



OSP2IGT063034



OSP2IGT063038

**1** Wide-front view camera

**2, 3** Wide-side view camera (under the side view mirror)

**4** Wide-rear view camera

Refer to the picture above for the detailed location of the detecting sensors.

## Surround View Monitor settings

### Warning methods

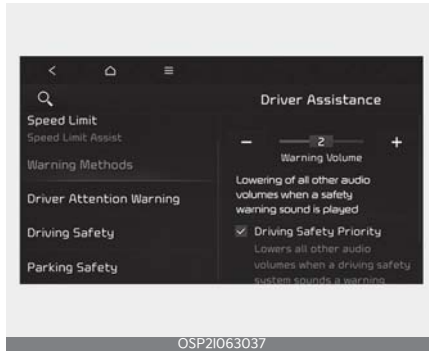

Warning methods can be set when the vehicle is in ON position.

- Parking safety priority: Select **Settings** → **Vehicle** → **Driver assistance** → **Warning methods** → **Parking safety priority** on the infotainment system. For safe parking, the audio volume will temporarily decrease while Rear View Monitor is operating.

#### \* NOTICE

- Ensure that **Warning methods** you have set may apply to the **Warning methods** of other driver assistance systems.
- **Warning methods** will maintain its last setting even if the vehicle is restarted.
- The setting menu may not be available for your vehicle depending on the vehicle features and specifications.

## Camera settings

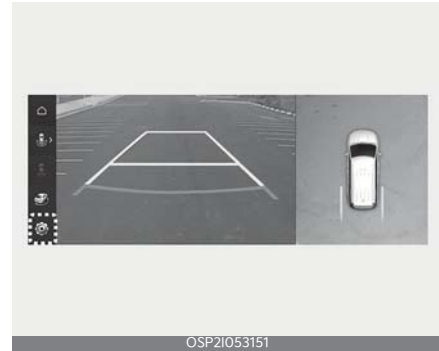

With the vehicle on, select the setup icon (⚙️) on the screen or **Settings** → **Vehicle** → **Driver assistance** → **Parking safety** → **Camera settings** from the infotainment system screen to change the Rear View Monitor settings.

- Display Contents: To change the settings of **Top view parking guidance**, **Parking guide in rear view**, and **Parking distance warning** function.
- Display Settings: To change the screen's brightness and contrast.

### Top View Parking Guidance

Front top view



Rear top view



Parking guidance is displayed on the right side of the Surround View Monitor screen when the **Front or Rear Top View Parking Guidance** is selected.

Rear View Parking Guidance



Rear view parking guidance is displayed in the rear view when the **Parking guide in rear view** is selected.

**\* NOTICE**

The horizontal guideline of the Rear View Parking Guidance shows the distance of 0.5 m (1.6 ft.), 1 m (3.3 ft.) and 2.3 m (7.6 ft.) from the vehicle.

Parking Distance Warning

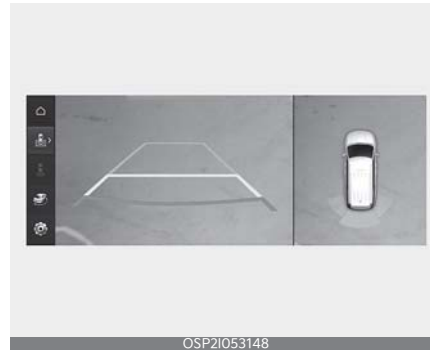

Parking distance warning is displayed on the right side of the Surround View Monitor top view screen when the **Parking distance warning** is selected.

Surround View Monitor Auto On

With the vehicle on, select **Settings** → **Vehicle** → **Driver assistance** → **Parking safety** → **Surround View Monitor Auto On** from the infotainment system screen to use the function.

**\* NOTICE**

For more details on Surround View Monitor Auto On, refer to "Surround View Monitor Auto On" on page 6-76.

## Surround View Monitor operation

### Parking/View button



Press the Parking/View button (1) to turn on or off Surround View Monitor.

### Front view

Front view function is displayed on the screen when the gear is in N (Neutral) or D (Drive) to assist in parking. The front view has a top view, front view, side view and 3D view. Also, other view modes can be selected by pressing the view icons on the Surround View Monitor screen.

### Operating conditions

Front view function will turn on when the following conditions are satisfied:

- Shifting from R (Reverse) to N (Neutral) or D (Drive) and the vehicle speed is below approximately 10 km/h (6 mph).
- Pressing the Parking/View button (1) when the gear is in D (Drive) or N (Neutral) and vehicle speed is below 10 km/h (6 mph).
- Forward Parking Distance Warning warns the driver while driving in D (Drive) (**Driver assistance** → **Parking safety** → **Surround View Monitor**)

**Auto On** selected from the Settings menu)

### Off conditions

Front view function will turn off when the following conditions are satisfied:

- Press the Parking/View button (1) or the infotainment system button (2).
- When vehicle speed is above 10 km/h (6 mph).
- Press one of the infotainment system button (2), the screen will change to the infotainment system screen.
- Shifting to P (Park).

### \* NOTICE

If Surround View Monitor is turned off after driving more than 10 km/h (6 mph), driving below 10 km/h (6 mph) again will not switch to the Surround View Monitor screen.

### Rear view

Rear view function is displayed on the screen when the gear is in R (Reverse) or P (Park) to assist in parking. The rear view has a top view, rear view, side view and 3D view. Also, other view modes can be selected by pressing the view icons on the Surround View Monitor screen.

### Operating conditions

Rear view function will turn on when the following conditions are satisfied:

- Shifting to R (Reverse).
- Pressing the Parking/View button (1) when P (Park) gear position is selected.



### Off conditions

Rear view function will turn off when the following conditions are satisfied:

- Shifting from R (Reverse) to P (Park).
- Pressing the Parking/View button (1) when P (Park) gear position is selected.

### \* NOTICE

Pressing the infotainment system button (2) will not turn the rear view off when the gear is in R (Reverse).

### 3D view function

3D view function shows the vehicle in various angles. Press the 3D view icon on the Surround View Monitor screen to choose the angle. Press the 3D view icon again to reset the angle.

### Operating conditions

3D view function will turn on when the following conditions are satisfied:

- Shifting to P (Park), N (Neutral) or D (Drive) and the vehicle speed is below 6 mph (10 km/h).
- When shifting to R (Reverse) and Surround View Monitor is on, Press 3D view icon on the Surround View Monitor screen.

### Off conditions

3D view function will turn off when the following conditions are satisfied:

- Vehicle in P (Park), N (Neutral) or D (Drive)
  - Shifting to P (Park)
  - Pressing the Parking/View button (1)
  - Pressing the infotainment button (2)

- Pressing the home button on the Surround View Monitor screen
- Vehicle speed is above 6 mph (10 km/h)
- Vehicle in R (Reverse)
  - Shifting to P (Park)

### \* NOTICE

3D view function does not display the parking guide.

### Rear view while driving

Rear view while driving provides the driver to check the rear view on the infotainment screen while driving to assist with safe driving.

### Operating conditions

- ENGINE START/STOP button is in the ON position.
- Parking/View button (1) is pressed with the gear in D (Drive) or N (Neutral).

### Off conditions

- Parking/View button (1) is pressed again.
- One of the infotainment system button (2) is pressed.

### When operating

- If the gear is changed to R (Reverse), while Driving rear view is displayed on the screen, the screen will change to rear view with parking guidance.
- When Rear View while driving is displayed on the screen, an icon will appear on the upper right side of the screen indicating that the rear view is being displayed.

## Surround View Monitor malfunction and limitations

### Surround View Monitor malfunction

When Surround View Monitor is not working properly, or the screen flickers, or the camera image does not display normally, have the vehicle checked by a professional workshop. Kia recommends to visit an authorized Kia dealer/service partner.

### Limitations of Surround View Monitor

- The screen may be displayed abnormally, and an icon will appear at the top left side of the screen under the following circumstances:
  - The tailgate is opened.
  - The driver or front passenger door is opened.
  - The outside rear view mirror is folded.

### ⚠ WARNING

- ALWAYS look around your vehicle to make sure there are no objects or obstacles before moving the vehicle. What you see on the screen may differ from the actual vehicle's location.
- The image shown on the screen may differ from the actual distance of the object. Make sure to directly check the vehicle's surroundings for safety.
- Surround View Monitor is designed to be used on a flat surface. Therefore, if used on roads with different heights such as curbs and speed bumps, the image in the screen may not look correct.
- If the camera lens is covered with foreign material, the Surround View Monitor may not operate normally.

Always keep the camera lens clean. However, do not use chemical solvents such as strong detergents containing high alkaline or volatile organic solvents (gasoline, acetone etc.). This may damage the camera lens.

### \* NOTICE

- When Rear View while Driving is on, it stays on while driving regardless of vehicle speed.
- When Rear View while Driving is on while Reversing, the screen changes to the rear view.

## Rear Cross-Traffic Collision-Avoidance Assist (RCCA) (if equipped)

Rear Cross-Traffic Collision-Avoidance Assist is designed to detect vehicles approaching from the rear left and right side whilst your vehicle is reversing, and warning the driver that a collision is imminent with a warning message and an audible warning. Also, to help prevent collisions, braking assist may be applied.



[A]: Rear Cross-Traffic Collision Warning operating range

[B]: Rear Cross-Traffic Collision-Avoidance Assist operating range

### ⚠ CAUTION

Warning Timing may vary depending on vehicle speed of the approaching vehicle.

## Detecting sensor

[1]: Rear corner radar



Refer to the picture above for the detailed location of the detecting sensor.

### ⚠ CAUTION

For more details on the precautions of the rear corner radar, refer to "Blind-Spot Collision-Avoidance Assist (BCA) (if equipped)" on page 6-24.

## Rear Cross-Traffic Collision-Avoidance Assist settings

### Rear cross-traffic safety



With ENGINE START/STOP button in the ON position, select 'User settings' → Driver assistance → 'Parking safety' on the LCD display or 'Settings' → Vehicle →

## Driver assistance system

Driver assistance → Parking safety' on the Infotainment system screen to turn on Rear Cross-Traffic Collision-Avoidance Assist.

### ⚠ WARNING

When the engine is restarted, Rear Cross-Traffic Collision-Avoidance Assist will always turn on. However, if Rear Cross-Traffic Safety is deselected after the vehicle is restarted, the driver should always be aware of the surroundings and drive safely.

### \* NOTICE

Settings for Rear Cross-Traffic Collision-Avoidance Assist include Rear Cross-Traffic Collision Warning and Rear Cross-Traffic Collision-Avoidance Assist.

### \* NOTICE

If the engine is restarted, Warning Timing and Warning Volume will maintain the last setting.

## Warning methods

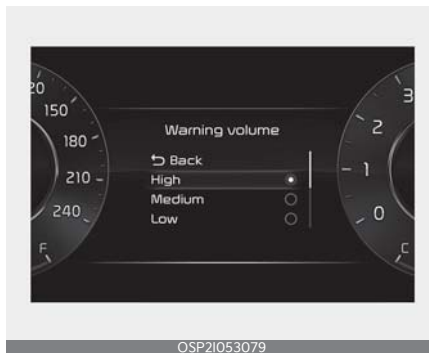

## Rear Cross-Traffic Collision-Avoidance Assist (RCCA)

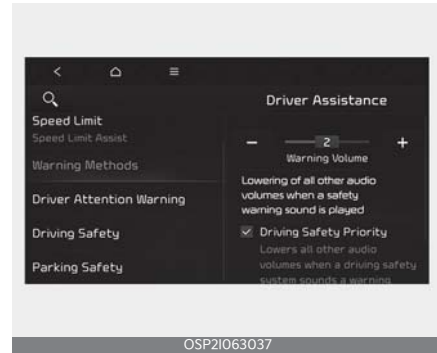

You can adjust the Warning methods with ENGINE START/STOP button in the ON position.

- Warning volume : Select 'User settings → Driver assistance → Warning volume' on the LCD display or 'Settings → Vehicle → Driver assistance → Warning methods' on the Infotainment system.
- Driving safety priority : Select 'Settings → Vehicle → Driver assistance → Warning methods → Driving safety priority' on the Infotainment system. For safe driving, the audio volume will temporarily decrease to warn the driver with the audible warning.

### \* NOTICE

- Ensure that Warning methods you have set may apply to the warning volume of other Driver Assistance systems.
- Warning methods will maintain its last setting even if the vehicle is restarted.
- The setting menu may not be available for your vehicle depending on the vehicle features and specifications.

## Rear Cross-Traffic Collision-Avoidance Assist operation

Rear Cross-Traffic Collision-Avoidance Assist will provide a warning and control the vehicle depending on collision level.

- Collision Warning
- Emergency Braking
- Stopping vehicle and ending brake control

## Collision Warning



- To warn the driver of an approaching vehicle from the rear left/right side of your vehicle, the warning light on the side view mirror will blink and a warning message will appear on the cluster. At the same time, an audible warning will sound.
- Rear Cross-Traffic Collision-Avoidance Assist will operate when the following conditions are satisfied:
  - Your vehicle gear is shifted to R (Reverse)
  - Your vehicle speed is below 8 km/h (5 mph)
  - The approaching vehicle is within approximately 25 m (82 ft.) from the left or right side of your vehicle
  - The speed of the vehicle approaching from the left or right side is above 5 km/h (3 mph)

### \* NOTICE

- If the operating conditions are satisfied, there will be a warning whenever the vehicle approaches from the left or right side even though your vehicle speed is 0 km/h (0 mph).
- The images and colours in the instrument cluster may differ depending on

the cluster type or theme selected from the settings menu.

### Emergency Braking



- Your vehicle, the warning light on the side view mirror will blink and a warn-

ing message will appear on the cluster. At the same time, an audible warning will sound.

- Rear Cross-Traffic Collision-Avoidance Assist will operate when the following conditions are satisfied:
  - Your vehicle gear is shifted to R (Reverse)
  - Your vehicle speed is below 8 km/h (5 mph)
  - The approaching vehicle is within approximately 1.5 m (5 ft.) from the left or right side of your vehicle
  - The speed of the vehicle approaching from the left or right side is above 5 km/h (3 mph)
- Emergency braking will be assisted to help prevent collision with approaching vehicles from the left and right.

#### ⚠ WARNING

- Brake control will end when:
  - The approaching vehicle is out of the detecting range
  - The approaching vehicle passes behind your vehicle
  - The approaching vehicle does not drive toward your vehicle
  - The approaching vehicle speed slows down
  - The driver depresses the brake pedal with sufficient power

## Stopping vehicle and ending brake control



When the vehicle is stopped due to emergency braking, the 'Drive carefully' warning message will appear on the cluster.

For your safety, the driver should depress the brake pedal immediately and check the surroundings.

- Brake control will end after the vehicle is stopped by emergency braking for approximately 2 seconds.
- During emergency braking, braking control by Rear Cross-Traffic Collision-Avoidance Assist will automatically cancel when the driver excessively depresses the brake pedal.

### **⚠ WARNING**

- For your safety, change the settings after parking the vehicle at a safe location.
- If any other function's warning message is displayed or audible warning is generated, Rear Cross-Traffic Collision-Avoidance Assist warning message may not be displayed and audible warning may not be generated.

- You may not hear the warning sound of Rear Cross-Traffic Collision-Avoidance Assist if the surrounding is noisy.
- Rear Cross-Traffic Collision-Avoidance Assist may not operate if the driver applies the brake pedal to avoid collision.
- During Rear Cross-Traffic Collision-Avoidance Assist operation, the vehicle may stop suddenly injuring passengers and shifting loose objects. Always have the seat belt on and keep loose objects secured.
- Even if there is a problem with Rear Cross-Traffic Collision-Avoidance Assist, the vehicle's basic braking performance will operate normally.

### **⚠ WARNING**

- During emergency braking, braking control by the function will automatically cancel when the driver excessively depresses the accelerator pedal.
- Rear Cross-Traffic Collision-Avoidance Assist does not operate in all situations and cannot avoid all collisions.
- Rear Cross-Traffic Collision-Avoidance Assist may warn the driver late or may not warn the driver depending on the road and driving conditions.
- The driver should hold the responsibility to control the vehicle. Do not solely depend on Rear Cross-Traffic Collision-Avoidance Assist. Rather, maintain a safe braking distance, and if necessary, depress the brake pedal to reduce driving speed or to stop the vehicle.
- Never deliberately test Rear Cross-Traffic Collision-Avoidance Assist on

people, animal, objects, etc. It may cause serious injury or death.

**⚠ CAUTION**

The brake control may not operate properly depending on the status of ESC (Electronic Stability Control). There will only be a warning when:

- The ESC (Electronic Stability Control) warning light is on
- ESC (Electronic Stability Control) is engaged in a different function

**\* NOTICE**

- If braking is assisted by Rear Cross-Traffic Collision-Avoidance Assist, the driver must immediately depress the brake pedal and check vehicle surroundings.
- After shifting the gear to R (Reverse), braking control will operate once for left and right vehicle approach.

**Rear Cross-Traffic Collision-Avoidance Assist malfunction and limitations**

**Rear Cross-Traffic Collision-Avoidance Assist malfunction**

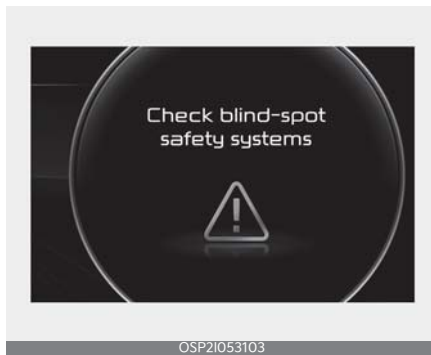

When Rear Cross-Traffic Collision-Avoidance Assist is not working properly, the warning message will appear for several seconds and the  warning light will appear on the cluster. In this case, have the system checked by a professional workshop. Kia recommends to visit an authorised Kia dealer/service partner.

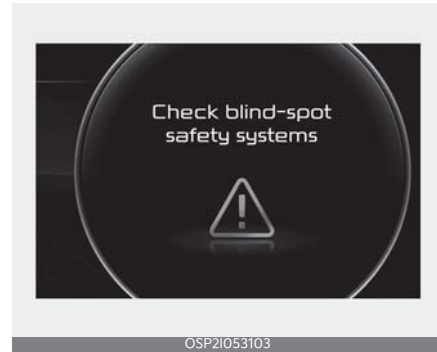

When the warning light on the side view mirror (outside mirror) is not working properly, the warning message will appear for several seconds and the  warning light will appear on the cluster. In this case, have the system checked by a professional workshop. Kia recommends to visit an authorised Kia dealer/service partner.

6



## Rear Cross-Traffic Collision-Avoidance Assist disabled



When the rear bumper around the rear corner radar or sensor is covered with foreign matters, such as snow or rain, or installing a trailer or carrier, it can reduce the detecting performance and temporarily limit or disable Rear Cross-Traffic Collision-Avoidance Assist.

If this occurs, the warning message will appear on the cluster. It is not a malfunction.

Rear Cross-Traffic Collision-Avoidance Assist will operate properly when such foreign matters or trailer, etc. is removed.

Always keep it clean.

If Rear Cross-Traffic Collision-Avoidance Assist does not operate normally after it is removed, take your vehicle to a professional workshop and have the system checked. Kia recommends to visit an authorised Kia dealer/service partner.

### **⚠ WARNING**

- Even though the warning message does not appear on the cluster, Rear Cross-Traffic Collision-Avoidance Assist may not properly operate.

- Rear Cross-Traffic Collision-Avoidance Assist may not properly operate in an area (for example, open terrain), where any objects are not detected after turning ON the engine.

### **⚠ CAUTION**

Turn off Rear Cross-Traffic Collision-Avoidance Assist to install a trailer, carrier, etc., and remove the trailer, carrier, etc. to use Rear Cross-Traffic Collision-Avoidance Assist.

## Limitations of Rear Cross-Traffic Collision-Avoidance Assist

Rear Cross-Traffic Collision-Avoidance Assist may not operate properly or it may operate unexpectedly under the following circumstances:

- Departing from where trees or grass is overgrown
- Departing from where roads are wet
- Speed of the approaching vehicle is fast or slow

Braking control may not work in the following circumstances:

- The vehicle severely vibrates whilst driving over a bumpy road, uneven road or concrete patch
- Driving on a slippery surface due to snow, water puddle, ice, etc.
- The tyre pressure is low or a tyre is damaged
- The brake is reworked

### **\* NOTICE**

For more details on the limitations of the rear corner radar, refer to "Blind-Spot Collision-Avoidance Assist (BCA) (if equipped)" on page 6-24.



[A]: Structure

Rear Cross-Traffic Collision-Avoidance Assist may be limited when driving near a vehicle or structure, and may not detect the vehicle approaching from the left or right. If this occurs, Rear Cross-Traffic Collision-Avoidance Assist may not warn the driver or control the brakes when necessary.

Always check your surroundings whilst backing up.

- **When the vehicle is in a complex parking environment**

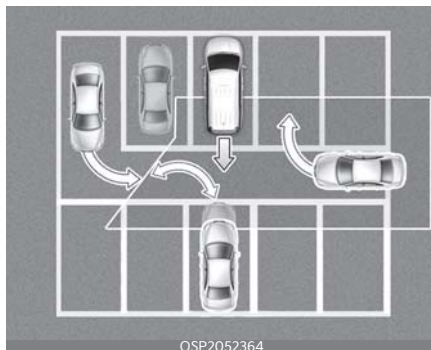

Rear Cross-Traffic Collision-Avoidance Assist may detect vehicles which are parking or pulling out near your vehicle

(for example, a vehicle leaving beside your vehicle, a vehicle parking or pulling out in the rear area, a vehicle approaching your vehicle making a turn, etc.). If this occurs, Rear Cross-Traffic Collision-Avoidance Assist may unnecessarily warn the driver and control the brake. Always check your surroundings whilst backing up.

- **When the vehicle is parked diagonally**



Rear Cross-Traffic Collision-Avoidance Assist may be limited when backing up diagonally, and may not detect the vehicle approaching from the left or right. If this occurs, Rear Cross-Traffic Collision-Avoidance Assist may not warn the driver or control the brakes when necessary.

Always check your surroundings whilst backing up.

- **When the vehicle is on or near a slope**

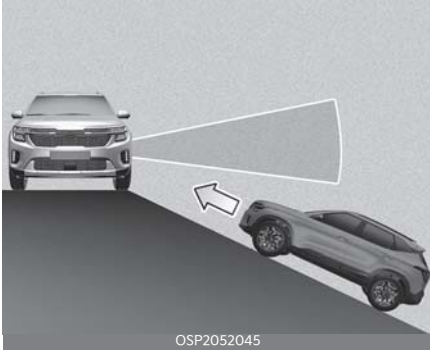

Rear Cross-Traffic Collision-Avoidance Assist may be limited when the vehicle is on an uphill or downhill slope, or near it, and may not detect the vehicle approaching from the left or right. If this occurs, Rear Cross-Traffic Collision-Avoidance Assist may not warn the driver or control the brakes when necessary.

Always check your surroundings whilst backing up.

- **Pulling into the parking space where there is a structure**

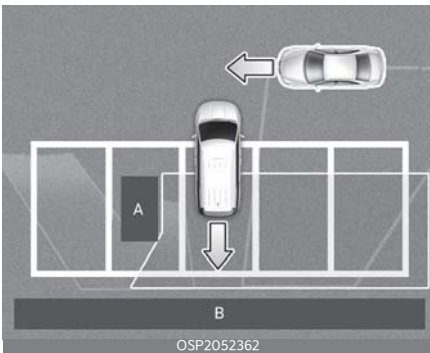

[A]: Structure, [B]: Wall

Rear Cross-Traffic Collision-Avoidance Assist may detect vehicles passing by in front of you when parking backwards

into a parking space with a wall or structure in the rear or side area. If this occurs, Rear Cross-Traffic Collision-Avoidance Assist may unnecessarily warn the driver and control the brake. Always check your surroundings whilst backing up.

- **When the vehicle is parked rearward**

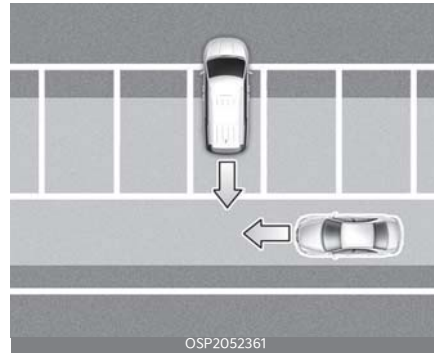

Rear Cross-Traffic Collision-Avoidance Assist may detect vehicles passing by behind you when parking backwards into a parking space. If this occurs, Rear Cross-Traffic Collision-Avoidance Assist may unnecessarily warn the driver and control the brake.

Always check your surroundings whilst backing up.

#### **⚠ WARNING**

- When you are towing a trailer or another vehicle, we recommend that Rear Cross-Traffic Collision-Avoidance Assist is turned off due to safety reasons.
- Rear Cross-Traffic Collision-Avoidance Assist may not operate normally if interfered with by strong electromagnetic waves.

## Driver assistance system

- Rear Cross-Traffic Collision-Avoidance Assist may not operate for 3 seconds after the vehicle is started, or the rear corner radars are initialized.

## Reverse Parking Distance Warning (PDW)

### Reverse Parking Distance Warning (PDW) (if equipped)

Reverse Parking Distance Warning will help warn the driver if a person, an animal or an object is detected within a certain distance when the vehicle is moving in reverse.

### Detecting sensor

[1]: Rear ultrasonic sensors



Refer to the picture above for the detailed location of the detecting sensors.

6

## Reverse Parking Distance Warning Operation

### Reverse Parking Distance Warning settings

#### Warning methods

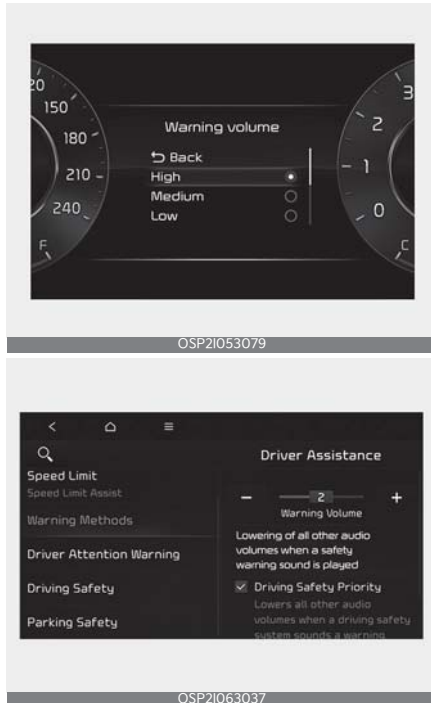

You can adjust the Warning methods with ENGINE START/ STOP button in the ON position.

- Warning volume : Select 'User settings → Driver assistance → Warning volume' on the LCD display or 'Settings → Vehicle → Driver assistance → Warning methods' on the Infotainment system.

#### \* NOTICE

- Ensure that Warning methods you have set may apply to the Warning

volume of other Driver assistance systems.



- Warning methods will maintain its last setting even if the vehicle is restarted.
- The setting menu may not be available for your vehicle depending on the vehicle features and specifications.

## Operation of Reverse Parking Distance Warning

### Reverse Parking Distance Warning

Reverse Parking Distance Warning will operate under the following conditions.

- Shift the gear to R (Reverse).
- The vehicle's speed is below 10 km/h (6 mph).

Types of warning sound	Indicator
When an object is 60 cm to 120 cm (24 inches to 48 inches) from the rear bumper: Buzzer beeps intermittently	
When an object is 30 cm to 60 cm (12 inches to 24 inches) from the rear bumper: Buzzer beeps more frequently.	
When an object is within 30 cm (12 inches) of the rear bumper: Buzzer beeps continuously.	

### Reverse Parking Distance Warning Malfunction and Precautions

#### Reverse Parking Distance Warning malfunction

After starting the vehicle, a beep will sound once when the gear is shifted to R (Reverse) to indicate Reverse Parking Distance Warning is operating normally. However, if one or more of the following occurs, first check whether the ultrasonic sensor is damaged or blocked with foreign material. If it still does not work properly, Kia recommends visiting an authorised Kia dealer/service partner.

- The audible warning does not sound.
- The buzzer sounds intermittently.
- The warning message appears on the cluster.

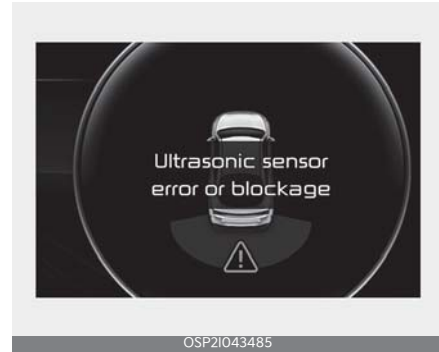

#### Reverse Parking Distance Warning disabled

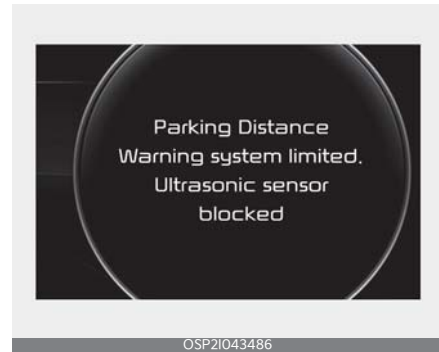

If this occurs, the warning message appears on the cluster. Reverse Parking Distance Warning will operate properly when snow, rain or foreign material is removed.

If Reverse Parking Distance Warning does not operate properly after obstruction (snow, rain, or foreign material) is removed (including trailer, carrier, etc., from the rear bumper), Kia recommends that you visit an authorised Kia dealer/service partner.

### Limitations of Reverse Parking Distance Warning

Reverse Parking Distance Warning may not operate normally when:

- Moisture is frozen to the sensor (Reverse Parking Distance Warning will operate normally when it is melted.)
- Sensor is covered with foreign material, such as snow or water (Reverse Parking Distance Warning will operate normally when such foreign material are removed.)
- The weather is extremely hot or cold
- The sensor or sensor assembly is disassembled
- The surface of the sensor is pressed hard or an impact is applied with a hard object
- The surface of the sensor is scratched with a sharp object
- The sensors or its surrounding area is directly sprayed with high pressure washer

Reverse Parking Distance Warning may malfunction when:

- Heavy rain or water spray is present
- Water flows on the surface of the sensor
- Affected by another vehicle's sensors
- The sensor is covered with snow
- Driving on uneven road, gravel roads or bushes
- Objects that generates ultrasonic waves are near the sensor
- Installing the license plate differently from the original location
- The vehicle bumper height or ultrasonic sensor installation has been modified

- Attaching equipments or accessories around the ultrasonic sensors

The following objects may not be detected:

- Sharp or slim objects, such as ropes, chains or small poles.
- Objects, which tend to absorb sensor frequency, such as clothes, spongy material or snow.
- Objects smaller than 100 cm (40 inches) length and narrower than 14 cm (6 inches) in diameter.
- Pedestrians, animals or objects that are very close to the ultrasonic sensors

#### WARNING

- Reverse Parking Distance Warning is a supplemental function. The operation of Reverse Parking Distance Warning can be affected by several factors (including environmental conditions). It is the responsibility of the driver to always check the rear view before and whilst parking.
- Your vehicle warranty does not cover any accidents or damage to the vehicle due to the malfunction of Reverse Parking Distance Warning.
- Pay close attention when driving near objects, pedestrians, and especially children. Some objects may not be detected by the ultrasonic sensors, due to the objects distance, size material, all of which can limit the effectiveness of the sensor.
- Parking Distance Warning indicator may not occur sequentially depending on vehicle speed or obstacle shape.
- If Forward/Reverse Parking Distance Warning needs repair, Kia recom-

## Driver assistance system

mends visiting an authorised Kia dealer/service partner.

---

## Forward/Reverse Parking Distance Warning (PDW)

### Forward/Reverse Parking Distance Warning (PDW) (if equipped)

Forward/Reverse Parking Distance Warning will help warn the driver if a person, an animal or an object is detected within a certain distance from the ultrasonic sensors when the vehicle is moving forward or in reverse.

[1]: Front ultrasonic sensors

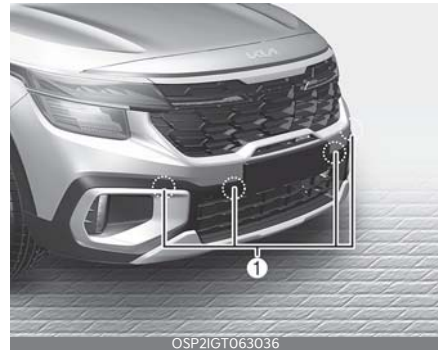

[2]: Rear ultrasonic sensors



Refer to the picture above for the detailed location of the detecting sensor.

6



## Forward/Reverse Parking Distance Warning Settings

### Warning methods

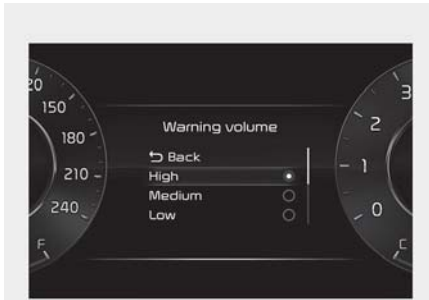

OSP21053079

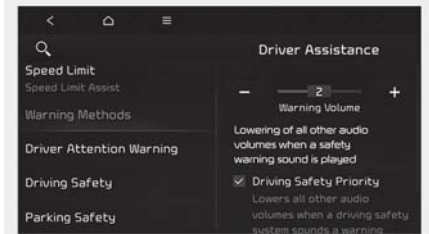

OSP21063037

You can adjust the Warning methods with ENGINE START/ STOP button in the ON position.

- Warning volume : Select 'User settings → Driver assistance → Warning methods' on the LCD display or 'Settings → Vehicle → Driver assistance → Warning methods' on the Infotainment system.

### \* NOTICE

- Ensure that Warning methods you have set may apply to the Warning volume of other Driver assistance systems.

- Warning methods will maintain its last setting even if the vehicle is restarted.
- The setting menu may not be available for your vehicle depending on the vehicle features and specifications.

### Auto PDW (Parking Distance Warning)

You can set the Parking Distance Warning to be ON at low speeds. To use Auto PDW (Parking Distance Warning) function, select 'User settings → Driver assistance → Parking safety → Auto PDW (Parking Distance Warning)' on the LCD display or 'Settings → Vehicle → Driver assistance → Parking safety → Auto PDW (Parking Distance Warning)' on the infotainment system with the Engine ON.

### Forward/Reverse Parking Distance Warning Operation

#### Parking Safety button



OSP21063041

- When Forward/Reverse Parking Distance Warning is off (button indicator light off), if you shift the gear to R (Reverse), Forward/Reverse Parking Distance Warning will automatically turn on.

## Driver assistance system

- If you shift the gear to R (Reverse), Forward/Reverse Parking Distance Warning will not turn off even if you press the Parking Safety (P) button for your safety.

### Forward Parking Distance Warning

Forward Parking Distance Warning will operate when one of the condition is satisfied.



- The gear is shifted from R (Reverse) to D (Drive)
- The gear is in D (Drive) and the Parking Safety (P) button indicator light is on
- Auto PDW (Parking Distance Warning) is selected from the Settings menu and the gear is in D (Drive)
- This function warns when Auto PDW (Parking Distance Warning) is selected and the gear is in D (Drive). ('User settings → Driver assistance → Parking safety → Auto PDW (Parking Distance Warning)' on the LCD display or 'Settings → Vehicle → Driver assistance → Parking safety → Auto PDW (Parking Distance Warning)' on the infotainment system)
- Vehicle speed is below 10 km/h (6 mph)

#### \* NOTICE

- Forward Parking Distance Warning does not operate when the vehicle's forward speed is above 10 km/h (6 mph) even when the function is on (Parking Safety button indicator is on). Forward Parking Distance Warning will operate again when the vehicle's forward speed decreases below 10 km/h (6 mph).

## Forward/Reverse Parking Distance Warning (PDW)

- When the vehicle's forward speed is above 30 km/h (18 mph), the Forward Parking Distance Warning will turn off (Parking Safety button indicator off). Although you drive below 10 km/h (6 mph) again, Forward Parking Distance Warning will not automatically turn on.

Distance from object	Warning indicator when driving forward	Warning sound
60~100 cm (24~40 inches)		Buzzer beeps intermittently
30~60 cm (12~24 inches)		Beeps more frequently
within 30 cm (12 inches)		Beeps continuously

- The corresponding indicator will appear on the cluster or infotainment system screen whenever each ultrasonic sensor detects a person, animal or object in its sensing range. Also an audible warning will sound.
- When more than two objects are detected at the same time, the closest one will be warned with an audible warning.
- Distance from object may be detected differently when obstacles are not located in front of the sensor.
- The shape of the indicator in the illustration may differ from the actual vehicle.

### Reverse Parking Distance Warning



Reverse Parking Distance Warning will operate when one of the condition is satisfied.

## Driver assistance system

- The gear is shifted to R (Reverse).
- The vehicle's rearward speed is below 10 km/h (6 mph).

### \* NOTICE

When the vehicle's rearward speed is below 10 km/h (6 mph), both the front and rear ultrasonic sensors will detect objects. However, the front ultrasonic sensors can detect a person, animal or object when it is within 60 cm (24 inches) from the sensors.

Distance from object	Warning indicator	Warning sound
	When driving backward	
60 ~120 cm (24~48 inches)		Buzzer beeps intermittently
30~60 cm (12~24 inches)		Buzzer beeps frequently
within 30 cm (12 inches)		Buzzer beeps continuously

- The corresponding indicator will appear on the cluster or infotainment system screen whenever each ultrasonic sensor detects a person, animal or object in its sensing range. Also an audible warning will sound.
- When more than two objects are detected at the same time, the closest one will be warned with an audible warning.
- Distance from object may be detected differently when obstacles are not located in front of the sensor.
- The shape of the indicator in the illustration may differ from the actual vehicle.

## Forward/Reverse Parking Distance Warning (PDW)

### Forward/Reverse Parking Distance Warning malfunction and precautions

#### Forward/Reverse Parking Distance Warning malfunction

After starting the vehicle, a beep will sound once when the gear is shifted to R (Reverse) to indicate Forward/Reverse Parking Distance Warning is operating normally.

However, if one or more of the following occurs, first check whether the ultrasonic sensor is damaged or blocked with foreign material. If it still does not work properly, Kia recommends visiting an authorised Kia dealer/service partner.

- The audible warning does not sound.
- The buzzer sounds intermittently.



## Reverse Parking Distance Warning disabled

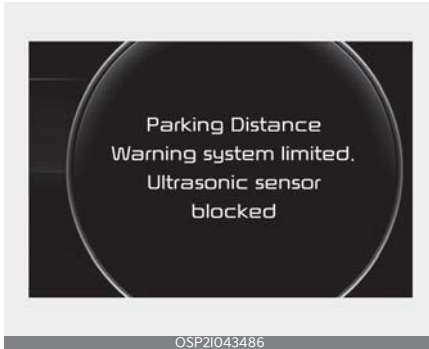

If this occurs, the warning message appears on the cluster. Reverse Parking Distance Warning will operate properly when snow, rain or foreign material is removed.

If Reverse Parking Distance Warning does not operate properly after obstruction (snow, rain, or foreign material) is removed (including trailer, carrier, etc., from the rear bumper), Kia recommends that you visit an authorised Kia dealer/ service partner.

### Limitations of Forward/Reverse Parking Distance Warning

Forward/Reverse Parking Distance Warning may not operate normally when:

- Moisture is frozen to the sensor (Forward/Reverse Parking Distance Warning will operate normally when it is melted.)
- Sensor is covered with foreign material, such as snow or water (Forward/Reverse Parking Distance Warning will operate normally when such foreign material are removed.)
- The weather is extremely hot or cold

- The sensor or sensor assembly is disassembled
- The surface of the sensor is pressed hard or an impact is applied with a hard object
- The surface of the sensor is scratched with a sharp object
- The sensors or its surrounding area is directly sprayed with high pressure washer

Forward/Reverse Parking Distance Warning may malfunction when:

- Heavy rain or water spray is present
- Water flows on the surface of the sensor
- Affected by another vehicle's sensors
- The sensor is covered with snow
- Driving on uneven road, gravel roads or bushes
- Objects that generates ultrasonic waves are near the sensor
- Installing the license plate differently from the original location
- The vehicle bumper height or ultrasonic sensor installation has been modified
- Attaching equipments or accessories around the ultrasonic sensors

The following objects may not be detected:

- Sharp or slim objects, such as ropes, chains or small poles.
- Objects, which tend to absorb sensor frequency, such as clothes, spongy material or snow.
- Objects smaller than 100 cm (40 inches) in length and narrower than 14 cm (6 inches) in diameter.
- Pedestrians, animals or objects that are very close to the ultrasonic sensors

**⚠ WARNING**

Forward/Reverse Parking Distance Warning is a supplemental function. The operation of Forward/Reverse Parking Distance Warning can be affected by several factors (including environmental conditions). It is the responsibility of the driver to always check the front and rear views before and whilst parking.

- Your vehicle warranty does not cover any accidents or damage to the vehicle due to the malfunction of Forward/Reverse Parking Distance Warning.
- Pay close attention when driving near objects, pedestrians, and especially children. Some objects may not be detected by the ultrasonic sensors, due to the objects distance, size or material, all of which can limit the effectiveness of the sensor.
- Parking Distance Warning indicator may not occur sequentially depending on vehicle speed or obstacle shape.
- If Forward/Reverse Parking Distance Warning needs repair, Kia recommends visiting an authorised Kia dealer/service partner.

**Declaration of conformity (if equipped)****The radio frequency components (Front radar) complies:**

For Korea



For United States and American territories, Micronesia, Dominican Republic, Honduras

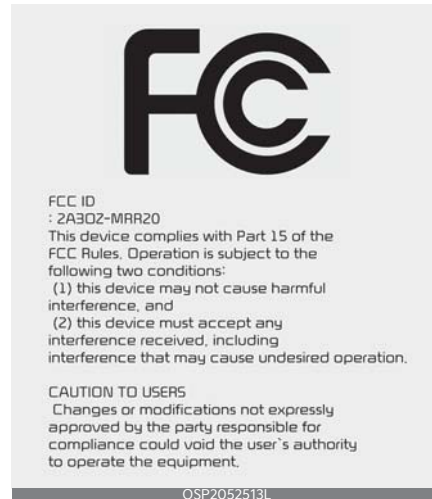

For Canada

Model: MRR-20  
IC: 27992-MRR20

This device complies with Industry Canada licence-exempt RSS standard(s). Operation is subject to the following two conditions:  
(1) this device may not cause interference, and  
(2) this device must accept any interference, including interference that may cause undesired operation of the device.

Le présent appareil est conforme aux CNR d'Industrie Canada applicables aux appareils radio exempts de licence. L'exploitation est autorisée aux deux conditions suivantes:  
(1) l'appareil ne doit pas produire de brouillage, et  
(2) l'utilisateur de l'appareil doit accepter tout brouillage radioélectrique subi, même si le brouillage est susceptible d'en compromettre le fonctionnement.

OSP2052514L

For United Kingdom



<https://hiklemove.com/solutions.html>

OSP2052516L

For Oman

OMAN-TRA
TRA/TA-R/13399/22
D202960

OSP2052517L

For Europe and countries subject to CE certification



Model : MRR-20

Hereby MRR-20 has been so constructed that it can be operated in at least one Member State without infringing applicable requirements of use of radio spectrum. (RED article 10.2)

Hereby, HL Klemove Corp declares that the radio equipment type MRR-20 is in compliance with Directive 2014/53/EU.

The full text of the EU declaration of conformity is available at the following as next page. (Case 1 : Include DoC in manual)

Case 2 : <https://hiklemove.com/solutions.html>

OSP2052515L

For Malaysia



HIDF16000136

OSP2052518L

For United Arab Emirates

	<p>TDRA - UNITED ARAB Emirates</p> <p>Make/Model ID Name: SM GLOBAL LLC</p> <p>T-ARTTY: ER055/08/22</p> <p>Model Name: MRR-20</p> <p>Product Type: Vehicle Radar</p>	
---	--	---

OSP2052520L

Driver assistance system

Declaration of conformity

For Jordan

TRC/31/9732/2022

OSP2052519L

For Uzbekistan



ODL3059239L

For Israel

תרושקתה דרשמ סעטמ המאתה רושיא רפסמ : 55-11767  
 רישכמה לש תויטוחלאה ויתונכת תא תונשל ידכ זהב שיש רשכמב תולועם עבצל רושיא לח  
 זה ללכבו  
 אלו תונשיח הנטאל רוביחל תורשפא תמסוה או תירוקמ הנטמ תמלה, הנכות ייוניש  
 רושיא תחלק  
 תויטוחלא תערפלה ששחה לשב, תרושקתה דרשמ

OSP2052521L

For Thailand



OSP2052522L

For Taiwan

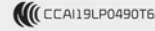

電信法第 48 條、低功率電波輻射性電機管理辦法

第十二條  
 經型式認證合格之低功率射頻電機，非經許可，公司、商號或使用者均不得擅自變更頻率、加大功率或變更原設計之特性及功能。

第十四條  
 低功率射頻電機之使用不得影響飛航安全及干擾合法通信；經發現有干擾現象時，應立即停用，並改善至無干擾時方得繼續使用。前項合法通信，指依電信法規定作業之無線電通信。低功率射頻電機須忍受合法通信或工業、科學及醫療用電波輻射性電機設備之干擾。

Article 12  
 Without permission, any company, firm or user shall not alter the frequency, increase the power, or change the characteristics and functions of the original design of the certified lower power frequency electric machinery.

Article 14  
 The application of low power frequency electric machineries shall not affect the navigation safety nor interface a legal communication, if an interference is found, the service will be suspended until improvement is made and the interference no longer exist.

OSP2052523L

For Paraguay



NR : 2021-03-I-0134

OSP2052524L

For Philippines



NTC

Type Approved  
 No. ESD-RCE-2229458

OSP2052525L

For Singapore

Complies with  
IMDA Standards  
N1588-22

OSP2052526L

For Mexico

IFT : RCPHLMR22-2324

OSP2052527L

For Brazil



03849-18-09644

OSP2052528L

For Indonesia



83759/SDPPI/2022  
13085



OSP2052531L

For China

CMIIT : 2022LJ14436

前碰撞防止辅助系统不是所有工况下都启动的。安装情况有可能无法避开碰撞。车辆的操作责任在驾驶员。随之，不得依赖前碰撞防止辅助系统而驾驶，应时刻确保安全距离并注视前方，应遵守驾驶员义务驾驶

OSP2052529L

For Republic of South Africa



TA-2021/3112

APPROVED

OSP2052530L

The radio frequency components (Rear corner radar) complies :

For United States and American territories, Micronesia, Dominican Republic, Honduras



OYB060040L

This device complies with Part 15 of the FCC Rules. Operation is subject to the following two conditions:

- (1) this device may not cause harmful interference, and
- (2) this device must accept any interference received, including interference that may cause undesired operation.

CAUTION TO USERS

Changes or modifications not expressly approved by the party responsible for compliance could void the user's authority to operate the equipment.

OYB060041L



## For Canada

Model: RS4  
IC: 2694A – RS4

This device contains licence-exempt transmitter(s)/receiver(s) that comply with Innovation, Science and Economic Development Canada's licence-exempt RSS(s). Operation is subject to the following two conditions:

- (1) This device may not cause interference.
- (2) This device must accept any interference, including interference that may cause undesired operation of the device.;

Le présent appareil est conforme aux CNR d'Industrie Canada applicables aux appareils radio exempts de licence. L'exploitation est autorisée aux deux conditions suivantes:

- (1) l'appareil ne doit pas produire de brouillage, et
- (2) l'utilisateur de l'appareil doit accepter tout brouillage radioélectrique subi, même si le brouillage est susceptible d'en compromettre le fonctionnement.

This equipment complies with ISED radiation exposure limits set forth for an uncontrolled environment. This equipment should be installed and operated with minimum distance of 20 cm between the radiator and your body. This transmitter must not be co-located or operating in conjunction with any other antenna or transmitter. Cet équipement est conforme aux limites d'exposition aux rayonnements ISED établies pour un environnement non contrôlé. Cet équipement doit être installé et utilisé avec un minimum de 20 cm de distance entre la source de rayonnement et votre corps. Ce transmetteur ne doit pas être placé au même endroit ou utilisé simultanément avec un autre transmetteur ou antenne.

OYB060042L

## For Taiwan

電信法第 48 條, 低功率電波輻射性電機管理辦法

## 第十二條

經型式認證合格之低功率射頻電機, 非經許可, 公司、商號或使用者均不得擅自變更頻率、加大功率或變更原設計之特性及功能。

## 第十四條

低功率射頻電機之使用不得影響飛航安全及干擾合法通信; 經發現有干擾現象時, 應立即停用, 並改善至無干擾時方得繼續使用。前項合法通信, 指依電信法規定作業之無線電通信。低功率射頻電機須忍受合法通信或工業、科學及醫療用電波輻射性電機設備之干擾。

## Article 12

Without permission, any company, firm or user shall not alter the frequency, increase the power, or change the characteristics and functions of the original design of the certified lower power frequency electric machinery.

## Article 14

The application of low power frequency electric machineries shall not affect the navigation safety nor interface a legal communication, if an interference is found, the service will be suspended until improvement is made and the interference no longer exist.

OYB060043L

## For Indonesia



Peringatan: Penggunaan perangkat radio, spesifikasi dan daya output, serta informasi lainnya, harus sesuai dengan ketentuan yang berlaku. Jika ada perubahan, harap segera menghubungi produsen.

73554/SDPPI/2021

13085

OYB052288L

For Malaysia



For Singapore



For Vietnam



For Brazil



Este equipamento não tem direito à proteção contra interferência prejudicial e não pode causar interferência em sistemas devidamente autorizados

OYB060049L

For Mexico

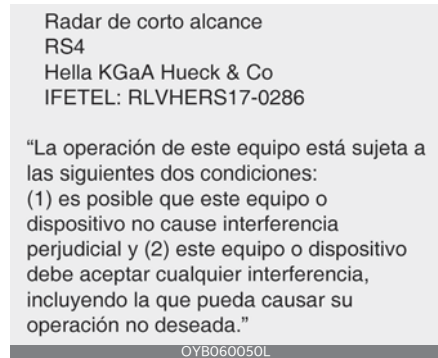

6

## For Japan

This device is granted pursuant to the Japanese Radio Law  
under the grant ID n° : 204-750001  
This device should not be modified (otherwise the granted designation number will become invalid)

本製品は、電波法に基づく特定無線設備の技術基準適合証明などを受けております。認証番号: 204-750001  
本製品の改造は禁止されています。(適合証明番号などが無効となります。)

OYB060051L

## For Oman

**OMAN - TRA**  
**TRA/TA-R/3957/17**  
**D080134**

OYB060055L

## For Ukraine



**UA RF: 1HELLARS4**

OYB060052L

## For United Arab Emirates

**TRA**  
**Registered No:**  
**ER53878/17**  
**Dealer No:**  
**DA44932/15**

OYB060056L

Цим HELLA GmbH & Co. KGaA заявляє, що радіотехнічне обладнання типу RS4 відповідає Технічному регламенту радіотехнічного обладнання та Директиві 2014/53/ЄС.

Повний текст декларації про відповідність доступний за адресою: [www.hella.com/hyundai](http://www.hella.com/hyundai)

Частотний діапазон: 24,05 – 24,25 ГГц  
Потужність передачі: 20 дБм (макс.) EIRP

OYB060053L

## For Botswana

**BTA**  
**REGISTERED No :**  
**BOCRA/TA/2018/3372**

OYB060057L

## For Jordan

TRC No. TRC/LPD/2017/63

OYB060054L

For Ghana

NCA Approved: 1R3-1M-7E1-0B7

OYB060058L

For Zambia



OYB060059L

For Jamaica

This product contains a Type Approved Module by Jamaica: SMA – “RS4”

OYB060060L

For Paraguay



OYB060061L

For Uzbekistan



ODL3059239L

For Mozambique

Approval No: N 1/R/SRA/2017  
HELLA RS4

OYB060062L

For Europe and countries subject to CE certification

In the user manual :

Hereby, Hella KGaA Hueck & Co. Declares that the radio equipment type RS4 is in compliance with Directive 2014/53/EU. The full text of the EU declaration of conformity is available at the following internet address:  
[www.hella.com/hyundai](http://www.hella.com/hyundai)

Technical information:  
Frequency range: 24.05 ... 24.25 GHz  
Transmission power: 20 dBm (maximum) EIRP

Manufacturer and Address:  
Hella KGaA Hueck & Co.  
Rixbecker Straße 75, 59552 Lippstadt, Germany

OYB060063L

For Korea

1. 상호 : HELLA KGAA HUECK & CO.
2. 기기명칭 및 모델명
  - 기기명칭: 음체감지센서용 무선기기 (24GHz 주파수대를 사용하는 기기)
  - 모델명: RS4
3. 제조자 및 제조국가
  - 제조자: HELLA KGAA HUECK & CO.
  - 제조국가: 독일, 미국, 중국, 한국

OSP2052533L

Driver assistance system

Declaration of conformity

For China

车辆驾驶辅助雷达系统型号：RCA型  
 最大功率额定无线电发射设备分类：H类  
 频率范围：24.05-24.25GHz  
 发射功率：20mW（等效全向辐射功率）  
 天线类型：高频平面贴片阵列天线  
 用户控制：不可  
 使用温度：-40~+85°C  
 电压：DC 9.0-16.0 V

不得擅自更改发射频率、加发射功率（包括额外加装频率功率放大器），不得擅自外接天线或改用其它发射天线  
 使用时不得对非经合法的无线电通信业务产生有害干扰；一旦发现有害干扰现象时，应立即停止使用，并采取相应措施排除干扰后方可继续使用  
 使用微功率无线电设备，必须耐受各种无线电业务的干扰或工业、科学及医疗应用设备的辐射干扰  
 配备等的电磁环境保护区域内使用微功率设备，应当遵守电磁环境保护及相关行业主管部门的规定

OYB052290L

For United Kingdom



Hereby, Hella GmbH & Co. KGaA declares that the radio equipment type R54 is in compliance with Radio Equipment Regulations of the United Kingdom.  
 The full text of the United Kingdom declaration of conformity is available at the following internet address: [www.hella.com/brand](http://www.hella.com/brand)

Technical information:  
 Frequency band: 24.05 ... 24.25 GHz  
 Transmission power: 20 dBm (max.) EIRP

Manufacturer and Address:  
 Hella GmbH & Co. KGaA  
 Rubbecker Straße 75, 59552 Lippstadt, Germany

Importer name and Address:

OYB052292L

For Israel



מסמך זה מפרט את הפרטים הטכניים של המכשיר המוגדר כ-FCC ID NB901R54. המכשיר מתאים לשימוש בתחום התדרים 24.05-24.25 GHz, עם כוח קלט מרבי של 20 mW (EIRP). המכשיר אינו צריך להיות מוגדר מחדש או מותאם לשימוש אחר. המכשיר אינו צריך להיות מוגדר מחדש או מותאם לשימוש אחר. המכשיר אינו צריך להיות מוגדר מחדש או מותאם לשימוש אחר.

OYB052291L

For Thailand



เครื่องวิทยุคมนาคมนี้ ได้รับยกเว้น ไม่ต้องได้รับใบอนุญาตให้มี ใช้ซึ่งเครื่องวิทยุคมนาคมหรือตั้งสถานีวิทยุคมนาคมตามประกาศ กสทช. เรื่อง เครื่องวิทยุคมนาคม และสถานีวิทยุคมนาคมที่ได้รับยกเว้นไม่ต้องได้รับใบอนุญาตวิทยุคมนาคม ตามพระราชบัญญัติวิทยุคมนาคม พ.ศ. 2498

nand. โคนกนก  
 กำกับดูแลสื่อสาธารณะ  
 Call Center 1300 (InsdB)

OBD06T093L

# What to do in an emergency **7**

<b>Road warning</b> .....	<b>7-3</b>
• Hazard warning flasher.....	7-3
<b>In case of an emergency whilst driving</b> .....	<b>7-3</b>
• If the engine stalls at a crossroad or crossing.....	7-3
• If you have a flat tyre whilst driving.....	7-3
• If the engine stalls whilst driving.....	7-4
<b>If the engine will not start</b> .....	<b>7-4</b>
• If the engine doesn't turn over or turns over slowly.....	7-4
• If engine turns over normally but does not start.....	7-4
<b>Emergency starting</b> .....	<b>7-5</b>
• Jump starting.....	7-5
• Push-starting.....	7-6
<b>If the engine overheats</b> .....	<b>7-7</b>
<b>Tyre Pressure Monitoring System (TPMS)</b> .....	<b>7-8</b>
• Tyre Pressure Indicator.....	7-8
• Low tyre pressure telltale.....	7-9
• Tyre Pressure Monitoring System (TPMS) malfunction indicator.....	7-10
• Tyre replacement with TPMS.....	7-11
<b>If you have a flat tyre (with spare tyre)</b> .....	<b>7-12</b>
• Jack and tools.....	7-12
• Removing and storing the spare tyre.....	7-13
• Changing tyres.....	7-13
• Jack label.....	7-17
• EC Declaration of conformity Jack.....	7-18
<b>Towing</b> .....	<b>7-19</b>
• Towing service.....	7-19
• Removable towing hook.....	7-20
• Emergency towing.....	7-20
<b>Emergency commodity</b> .....	<b>7-23</b>

# 7 What to do in an emergency

- First aid kit..... 7-23
- Triangle reflector..... 7-23

## What to do in an emergency

### Road warning

When in an emergency situation occurs whilst driving or when you park by the edge of the roadway, you must alert approaching or passing vehicles to be careful as they pass. For this, you should use the hazard warning flasher.

### Hazard warning flasher

The hazard warning flasher serves as a warning to other drivers to exercise extreme caution when approaching, overtaking, or passing your vehicle.



It should be used whenever emergency repairs are being made or when the vehicle is stopped near the edge of a roadway.

Depress the flasher switch with the ignition switch in any position. The flasher switch is located in between the centre air vents. All turn signal lights will flash simultaneously.

- The hazard warning flasher operates whether your vehicle is running or not.
- The turn signals do not work when the hazard flasher is on.
- Care must be taken when using the hazard warning flasher whilst the vehicle is being towed.

### In case of an emergency whilst driving

If an emergency situation occurs whilst driving, stay calm and take the following steps.

#### If the engine stalls at a crossroad or crossing

- If the engine stalls at a crossroad or crossing, set the shift lever in the N (Neutral) position and then push the vehicle to a safe place.
- If your vehicle has a manual transmission not equipped with an ignition lock switch, the vehicle can move forward by shifting to the 2 (Second) or 3 (Third) gear and then turning the starter without depressing the clutch pedal.

#### If you have a flat tyre whilst driving

If a tyre goes flat whilst you are driving:

1. Take your foot off the accelerator pedal and let the vehicle slow down whilst driving straight ahead. Do not apply the brakes immediately or attempt to pull off the road as this may cause a loss of control.
2. When the vehicle has slowed down to such a speed that it is safe to do so, brake carefully and pull off the road.
3. Park the vehicle at the side of road, do not stop or park the vehicle in middle of the road way. In case of divided roads, park the vehicle as much away from the driving lanes to avoid inconvenience to other vehicles and, easy operation of tyre change as mentioned in page 7-15.
4. When the vehicle is stopped, turn on your emergency hazard flashers, set the parking brake and put the trans-



mission in reverse (manual transmission).

5. Have all passengers get out of the vehicle. Be sure they all get out on the side of the vehicle that is away from traffic.
6. When changing a flat tyre, follow the instruction provided later in "If you have a flat tyre (with spare tyre)" on page 7-12.

### If the engine stalls whilst driving

1. Reduce your speed gradually, keeping a straight line. Move cautiously off the road to a safe place.
2. Turn on your emergency flashers.
3. Try to start the engine again. If your vehicle does not start, consult a professional workshop. Kia recommends to consult an authorised Kia dealer/service partner.

### If the engine will not start

When the engine doesn't start, first check to see how much fuel there is and whether the battery is discharged.

### If the engine doesn't turn over or turns over slowly

1. Check the battery connections to be sure they are clean and tight.
2. Turn on the interior light. If the light dims or goes out when you operate the starter, the battery is discharged.
3. Check the starter connections to be sure they are securely tightened.
4. Do not push or pull the vehicle to start it. See instructions for "Jump starting" on page 7-5.

#### WARNING

If the engine will not start, do not push or pull the vehicle to start it. This could result in a collision or cause other damage. In addition, push or pull starting may cause the catalytic converter to be overloaded and create a fire hazard.

### If engine turns over normally but does not start

1. Check the fuel level.
2. With the ignition switch in the LOCK position, check all connectors at the ignition coils and spark plugs. Reconnect any that may be disconnected or loose.
3. Check the fuel line in the engine compartment.
4. If the engine still does not start, call a professional workshop. Kia recommends to call an authorised Kia dealer/service partner.

## Emergency starting

When the vehicle will not start because of low battery power, you may need to jump start the vehicle.

### Jump starting

Connect cables in numerical order and disconnect in reverse order.

Smartstream G1.5/Smartstream G1.5 T-GDi



(Diesel) 1.5 VGT

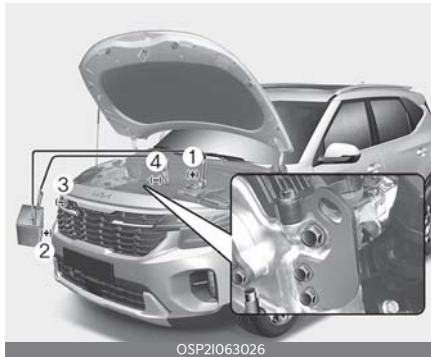

Jump starting can be dangerous if done incorrectly. Therefore, to avoid harm to yourself or damage to your vehicle or battery, follow the jump starting procedures. If in doubt, we strongly recommend that you have a competent technician or towing service jump start your vehicle.

### ⚠ CAUTION

Use only a 12-volt jumper system. You can damage a 12-volt starting motor, ignition system, and other electrical parts beyond repair by use of a 24-volt power supply (either two 12-volt batteries in series or a 24-volt motor generator set).

### ⚠ WARNING

#### Battery

Never attempt to check the electrolyte level of the battery as this may cause the battery to rupture or explode causing serious injury.

### ⚠ WARNING

#### Battery

- Keep all flames or sparks away from the battery. The battery produces hydrogen gas which may explode if exposed to flame or sparks. If these instructions are not followed exactly, serious personal injury and damage to the vehicle may occur! If you are not sure how to follow this procedure, seek qualified assistance. Automobile batteries contain sulfuric acid. This is poisonous and highly corrosive. When jump starting, wear protective glasses and be careful not to get acid on yourself, your clothing or on the vehicle.
- Do not attempt to jump start the vehicle if the discharged battery is frozen or if the electrolyte level is low; the battery may rupture or explode.
- Do not allow the (+) and (-) jumper cables to touch. It may cause sparks.

- The battery may rupture or explode when you jump start with a low or frozen battery.

### Jump starting procedure

1. Make sure the booster battery is 12-volt and that its negative terminal is grounded.  
If the booster battery is in another vehicle, do not allow the vehicles come in contact.
2. Turn off all unnecessary electrical loads.
3. Open the engine bonnet and remove the service cover on the front passenger seat side in the engine compartment.
4. Remove the fuse box cover on the front passenger seat side in the engine compartment
5. Open the positive terminal cap inside the engine room fuse box and the negative terminal cap close to the vehicle body.
6. Connect the jumper cables in the exact sequence shown in the illustration.
  - 1) Connect one end of a jumper cable to the positive terminal of the discharged battery (1).
  - 2) Connect the other end to the positive terminal of the booster battery (2).
  - 3) Proceed to connect one end of the other jumper cable to the negative terminal of the booster battery (3), then the other end to a solid, stationary, metallic point (for example, the engine lifting bracket) away from the battery (4). Do not connect it to or near any part that moves when the engine is cranked.

Do not allow the jumper cables to contact anything except the correct battery terminals or the correct ground. Do not lean over the battery when making connections.

### ⚠ CAUTION

#### Battery cables

Do not connect the jumper cable from the negative terminal of the booster battery to the negative terminal of the discharged battery. This can cause the discharged battery to overheat and crack, releasing battery acid.

Make sure to connect one end of the jumper cable to the negative terminal of the booster battery, and the other end to a metallic point, far away from the battery.

### Push-starting

Your Manual Transmission-equipped vehicle should not be push-started because it might damage the emission control system.

Vehicles equipped with Automatic Transmission/Intelligent Variable Transmission/Dual Clutch Transmission cannot be push-started. Follow the directions in this section for "Jump starting" on page 7-5.

### ⚠ WARNING

Never tow a vehicle to start it because the sudden surge forward when the engine starts could cause a collision with the tow vehicle.

## If the engine overheats

If your temperature gauge indicates overheating, you will experience a loss of power, or hear loud pinging or knocking, the engine is probably too hot.

If this happens, you should:

1. Pull off the road and stop as soon as it is safe to do so.
2. Place the shift lever in P (Automatic Transmission/Intelligent Variable Transmission/Dual Clutch Transmission) or neutral (Manual Transmission) and set the parking brake.
3. If the air conditioning is on, turn it off.
4. If engine coolant is running out under the vehicle or steam is coming out from the bonnet, stop the engine. Do not open the bonnet until the coolant has stopped running or the steaming has stopped.
5. If there is no visible loss of engine coolant and no steam, leave the engine running and check to be sure the engine cooling fan is operating.
  - 1) If the fan is not running, turn the engine off.
6. Check to see if the water pump drive belt is missing.
  - 1) If it is not missing, check to see that it is tight.
  - 2) If the drive belt seems to be satisfactory, check for coolant leaking from the radiator, hoses or under the vehicle. (If the air conditioning had been in use, it is normal for cold water to be draining from it when you stop).

### WARNING

Whilst the engine is running, keep hair, hands and clothing away from moving

parts such as the fan and drive belts to prevent injury.

7. If the water pump drive belt is broken or engine coolant is leaking out, stop the engine immediately and call the nearest authorised Kia dealer/service partner.

### WARNING

Do not remove the radiator cap when the engine is hot. This can allow coolant to blow out of the opening and cause serious burns.

8. If you cannot find the cause of the overheating, wait until the engine temperature has returned to normal. If coolant has been lost, carefully add coolant to the reservoir to bring the fluid level in the reservoir up to the halfway mark.
9. Proceed with caution, keeping alert for further signs of overheating. If overheating happens again, call an authorised Kia dealer/service partner.

### CAUTION

- Serious loss of coolant indicates there is a leak in the cooling system. In this case, have the system checked by a professional workshop. Kia recommends to visit an authorised Kia dealer/service partner.
- When the engine overheats from low engine coolant, suddenly adding engine coolant may cause cracks in the engine. To prevent damage, add engine coolant slowly in small quantities.

## Tyre Pressure Monitoring System (TPMS)

The Tyre Pressure Monitoring System (TPMS) detects the pressure of vehicle's tyres and displays it on the LCD display.



1. Low tyre pressure telltale / TPMS malfunction indicator
2. Low tyre pressure position telltale (Shown on the LCD display)

### Tyre Pressure Indicator

- You can check the tyre pressure in the assist mode on the cluster.
  - Refer to "LCD display" on page 4-49.
- Tyre pressure is displayed 1~2 minutes later after driving.
- If tyre pressure is not displayed when the vehicle is stopped, "Drive to dis-

play" message displays. After driving, check the tyre pressure.

- You can change the tyre pressure unit in the user settings mode on the cluster.
  - psi, kPa, bar (Refer to "LCD display" on page 4-49).

Each tyre, including the spare (if provided), should be checked monthly when cold and inflated to the inflation pressure recommended by the vehicle manufacturer on the vehicle placard or tyre inflation pressure label.

(If your vehicle has tyres of a different size than the size indicated on the vehicle placard or tyre inflation pressure label, you should determine the proper tyre inflation pressure for those tyres.)

As an added safety feature, your vehicle has been equipped with a tyre pressure monitoring system (TPMS) that illuminates a low tyre pressure telltale when one or more of your tyres is significantly under-inflated. Accordingly, when the low tyre pressure telltale illuminates, you should stop and check your tyres as soon as possible, and inflate them to the proper pressure. Driving on a significantly under-inflated tyre causes the tyre to overheat and can lead to tyre failure. Under-inflation also reduces fuel efficiency and tyre tread life, and may affect the vehicle's handling and stopping ability.

Please note that the TPMS is not a substitute for proper tyre maintenance, and it is the driver's responsibility to maintain correct tyre pressure, even if under-inflation has not reached the level to trigger illumination of the TPMS low tyre pressure telltale.

Your vehicle has also been equipped with a TPMS malfunction indicator to

indicate when the system is not operating properly. The TPMS malfunction indicator is combined with the low tyre pressure telltale. When the system detects a malfunction, the telltale will flash for approximately 1 minute and then remain continuously illuminated. This sequence will continue upon subsequent vehicle start-ups as long as the malfunction exists. When the TPMS malfunction indicator remains illuminated after blinking for approximately 1 minute, the system may not be able to detect or signal low tyre pressure as intended.

TPMS malfunctions may occur for a variety of reasons, including the installation of replacement or alternate tyres or wheels on the vehicle that prevent the TPMS from functioning properly. Always check the TPMS malfunction telltale after replacing one or more tyres or wheels on your vehicle to ensure that the replacement or alternate tyres and wheels allow the TPMS to continue to function properly.

**\* NOTICE**

If any of the below happens, have the system checked by a professional workshop. Kia recommends to visit an authorised Kia dealer/service partner.

1. The low tyre pressure telltale/ TPMS malfunction indicator do not illuminate for 3 seconds when the ignition switch is turned to the ON position or engine is running.
2. The TPMS malfunction indicator remains illuminated after blinking for approximately 1 minute.
3. The Low tyre pressure position telltale remains illuminated.

**Low tyre pressure telltale (!)**

**Low tyre pressure position telltale**

When the tyre pressure monitoring system warning indicators are illuminated and warning message displayed on the cluster LCD display, one or more of your tyres is significantly under-inflated.



The low tyre pressure position telltale light will indicate which tyre is significantly under-inflated by illuminating the corresponding position light.

If either telltale illuminates, immediately reduce your speed, avoid hard cornering and anticipate increased stopping distances. You should stop and check your tyres as soon as possible. Inflate the tyres to the proper pressure as indicated on the vehicle's placard or tyre inflation pressure label located on the driver's side centre pillar outer panel. If you cannot reach a service station or if the tyre cannot hold the newly added air, replace the low pressure tyre with a spare tyre.

If you drive the vehicle for about 10 minutes at speeds above 25 km/h after replacing the low pressure tyre with the spare tyre, one of the following will happen:

- The TPMS malfunction indicator may blink for approximately 1 minute and then remain continuously illuminated because the TPMS sensor is not mounted on the spare wheel. (changed tyre equipped with a sensor not in the vehicle)
- The TPMS malfunction indicator will remain continuously illuminated whilst driving because the TPMS sensor is not mounted on the spare wheel. (changed tyre equipped with a sensor in the vehicle)

**⚠ CAUTION**

- In winter or cold weather, the low tyre pressure telltale may illuminate if the tyre pressure was adjusted to the recommended tyre inflation pressure in warm weather. It does not mean your TPMS is malfunctioning because the decreased temperature leads to a lowering of tyre pressure.
- When you drive your vehicle from a warm area to a cold area or from a cold area to a warm area, or the outside temperature is higher or lower, you should check the tyre inflation pressure and adjust the tyres to the recommended tyre inflation pressure.
- When filling tyres with more air, conditions to turn off the low tyre pressure telltale may not be met. This is because a tyre inflator has a margin of error in performance. The low tyre pressure telltale will be turned off if the tyre pressure is above the recommended tyre inflation pressure.

**⚠ WARNING**

**Low pressure damage**

Significantly low tyre pressure makes the vehicle unstable and can contribute

to loss of vehicle control and increased braking distances.

Continued driving on low pressure tyres can cause the tyres to overheat and fail.

**Tyre Pressure Monitoring System (TPMS) malfunction indicator (!)**

The TPMS malfunction indicator will illuminate after it blinks for approximately one minute when there is a problem with the Tyre Pressure Monitoring System.

In this case, have the system checked by a professional workshop to determine the cause of the problem. Kia recommends to visit an authorised Kia dealer/service partner.

**\* NOTICE**

If there is a malfunction with the TPMS, the low tyre pressure position telltale will not be displayed even though the vehicle has an underinflated tyre.

**⚠ CAUTION**

- The TPMS malfunction indicator may blink for approximately 1 minute and then remain continuously illuminated if the vehicle is moving around electric power supply cables or radios transmitter such as at police stations, government and public offices, broadcasting stations, military installations, airports, or transmitting towers, etc. This can interfere with normal operation of the Tyre Pressure Monitoring System (TPMS).
- The TPMS malfunction indicator may blink for approximately 1 minute and then remain continuously illuminated if snow chains are used or some separate electronic devices such as notebook computer, mobile charger,

remote starter or navigation etc., are used in the vehicle.

This can interfere with normal operation of the Tyre Pressure Monitoring System (TPMS).

### Tyre replacement with TPMS

If you have a flat tyre, the low Tyre Pressure and Position telltales will come on. In this case, have the system checked by a professional workshop. Kia recommends to visit an authorised Kia dealer/service partner.

#### CAUTION

We recommend that you use the sealant approved by Kia.

The sealant on the tyre pressure sensor and wheel shall be eliminated when you replace the tyre with a new one.

Each wheel is equipped with a tyre pressure sensor mounted inside the tyre behind the valve stem. You must use TPMS specific wheels. Have your tyres serviced by a professional workshop. Kia recommends to visit an authorised Kia dealer/service partner.

If you drive the vehicle for about 10 minutes at speeds above 25 km/h after replacing the low pressure tyre with the spare tyre, one of the following will happen:

- The TPMS malfunction indicator may blink for approximately 1 minute and then remain continuously illuminated because the TPMS sensor is not mounted on the spare wheel. (changed tyre equipped with a sensor not in the vehicle)
- The TPMS malfunction indicator will remain continuously illuminated whilst driving because the TPMS sen-

sor is not mounted on the spare wheel. (changed tyre equipped with a sensor in the vehicle)

You may not be able to identify a low tyre by simply looking at it. Always use a good quality tyre pressure gauge to measure the tyre's inflation pressure. Please note that a tyre that is hot (from being driven) will have a higher pressure measurement than a tyre that is cold (from sitting stationary for at least 3 hours and driven less than 1.6 km (1 mile) during that 3 hour period).

Allow the tyre to cool before measuring the inflation pressure. Always be sure the tyre is cold before inflating to the recommended pressure.

A cold tyre means the vehicle has been sitting for 3 hours and driven for less than 1.6 km (1 mile) in that 3 hour period.

#### CAUTION

We recommend that you use the sealant approved by Kia if your vehicle is equipped with a Tyre Pressure Monitoring System. The liquid sealant can damage the tyre pressure sensors.

#### WARNING

##### TPMS

- The TPMS cannot alert you to severe and sudden tyre damage caused by external factors such as nails or road debris.
- If you feel any vehicle instability, immediately take your foot off the accelerator, apply the brakes gradually and with light force, and slowly move to a safe position off the road.



**⚠ WARNING**

**Protecting TPMS**

Tampering with, modifying, or disabling the Tyre Pressure Monitoring System (TPMS) components may interfere with the system's ability to warn the driver of low tyre pressure conditions and/or TPMS malfunctions. Tampering with, modifying, or disabling the Tyre Pressure Monitoring System (TPMS) components may void the warranty for that portion of the vehicle.

**If you have a flat tyre (with spare tyre)**

**Jack and tools**

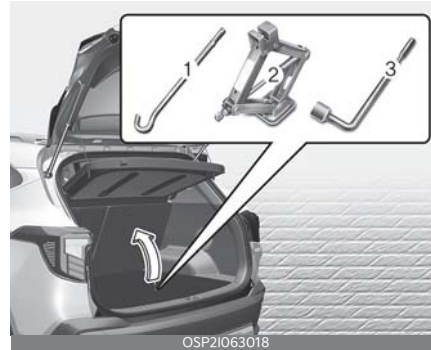

The jack, jack handle, wheel lug nut wrench are stored in the luggage compartment.

Pull up the luggage box cover to reach this equipment.

1. Jack handle
2. Jack
3. Wheel lug nut wrench

**Jacking instructions**

The jack is provided for emergency tyre changing only.

To prevent the jack from "rattling" whilst the vehicle is in motion, store it properly.

Follow jacking instructions to reduce the possibility of personal injury.

**⚠ WARNING**

**Changing tyres**

- Never attempt vehicle repairs in the traffic lanes of a public road or highway.
- Always move the vehicle completely off the road and onto the shoulder before trying to change a tyre. The jack should be used on level firm ground. If you cannot find a firm, level

## What to do in an emergency

place off the road, call a towing service company for assistance.

- Be sure to use the correct front and rear jacking positions on the vehicle; never use the bumpers or any other part of the vehicle for jacking support.
- The vehicle can easily roll off the jack causing serious injury or death.
- Do not get under a vehicle that is supported by a jack.
- Do not start or run the engine whilst the vehicle is on the jack.
- Do not allow anyone to remain in the vehicle whilst it is on the jack.
- Make sure any children present are in a secure place away from the road and from the vehicle to be raised with the jack.

## Removing and storing the spare tyre



Turn the tyre hold-down wing bolt counterclockwise to remove.

Store the tyre in the reverse order of removal.

To prevent the spare tyre and tools from "rattling" whilst the vehicle is in motion, store them properly.

## If you have a flat tyre (with spare tyre)

### **⚠ WARNING**

Ensure the spare tyre retainer is properly aligned with the centre of the spare tyre to prevent the spare tyre from "rattling". Otherwise, it may cause the spare tyre to fall off the carrier and lead to an accident.

### Changing tyres

1. Park on a level surface and apply the parking brake firmly.



2. Move the shift lever into R (Reverse) with Manual Transmission or P (Park) with Automatic Transmission/Intelligent Variable Transmission/Dual Clutch Transmission.
3. Activate the hazard warning flasher.
4. Remove the wheel lug nut wrench, jack, jack handle, and spare tyre from the vehicle.
5. Block both the front and rear of wheel that is diagonally opposite the jack position.

## What to do in an emergency



### **⚠ WARNING**

#### **Changing a tyre**

- To prevent vehicle movement whilst changing a tyre, always set the parking brake fully, and always block the wheel diagonally opposite the wheel being changed.
- We recommend that the wheels of the vehicle be chocked, and that no person remain in a vehicle that is being jacked.

6. Loosen the wheel lug nuts counter-clockwise one turn each, but do not remove any nut until the tyre has been raised off the ground.



7. Place the jack at the front (1) or rear (2) jacking position closest to the tyre

## If you have a flat tyre (with spare tyre)

you are changing. Place the jack at the designated locations under the frame. The jacking positions are plates welded to the frame with two tabs and a raised dot to index with the jack.

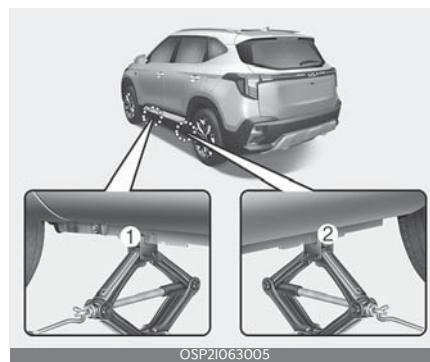
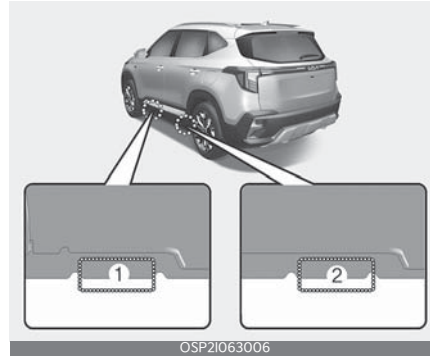

### **⚠ WARNING**

#### **Jack location**

To reduce the possibility of injury, be sure to use only the jack provided with the vehicle and in the correct jack position; never use any other part of the vehicle for jack support.

8. Insert the jack handle into the jack and turn it clockwise, raising the vehicle until the tyre just clears the ground. This measurement is approxi-

## What to do in an emergency

mately 30 mm (1.2 in). Before removing the wheel lug nuts, make sure the vehicle is stable and that there is no chance for movement or slippage.



9. Loosen the wheel nuts and remove them with your fingers. Slide the wheel off the studs and lay it flat so it cannot roll away. To put the wheel on the hub, pick up the spare tyre, line up the holes with the studs and slide the wheel onto them.

If this is difficult, tip the wheel slightly and get the top hole in the wheel lined up with the top stud. Then jiggle the wheel back and forth until the wheel can be slid over the other studs.

### **⚠ WARNING**

Wheels may have sharp edges. Handle them carefully to avoid possible severe injury. Before putting the wheel into place, be sure that there is nothing on the hub or wheel (such as mud, tar, gravel, etc.) that interferes with the wheel from fitting solidly against the hub.

If there is, remove it. If there is not good contact on the mounting surface between the wheel and hub, the wheel nuts could come loose and cause the loss of a wheel. Loss of a wheel may

## If you have a flat tyre (with spare tyre)

result in loss of control of the vehicle. This may cause serious injury or death.

### **Important - use of compact spare tyre (if equipped)**

Your vehicle is equipped with a compact spare tyre. This compact spare tyre takes up less space than a regular-size tyre. This tyre is smaller than a conventional tyre and is designed for temporary use only.

### **⚠ CAUTION**

- You should drive carefully when the compact spare is in use. The compact spare should be replaced by the proper conventional tyre and rim at the first opportunity.
- The operation of this vehicle is not recommended with more than one compact spare tyre in use at the same time.

### **⚠ WARNING**

The compact spare tyre is for emergency use only. Do not operate your vehicle on this compact spare at the speed over 80 km/h (50 mph). The original tyre should be repaired or replaced as soon as possible to avoid failure of the spare possibly leading to personal injury or death.

The compact spare should be inflated to 420 kPa (60 psi).

### **\* NOTICE**

Check the inflation pressure after installing the spare tyre. Adjust it to the specified pressure, as necessary.

When using a compact spare tyre, observe the following precautions:

### What to do in an emergency

- Under no circumstances should you exceed 80 km/h (50 mph); a higher speed could damage the tyre.
- Ensure that you drive slowly enough to avoid all hazards. Any road hazard, such as a pothole or debris, could seriously damage the compact spare.
- Any continuous road use of this tyre could result in tyre failure, loss of vehicle control, and possible personal injury.
- Do not exceed the vehicle's maximum load rating or the load-carrying capacity shown on the sidewall of the compact spare tyre.
- Avoid driving over obstacles. The compact spare tyre diameter is smaller than the diameter of a conventional tyre and reduces the ground clearance approximately 2.5 cm (1 inch), which could result in damage to the vehicle.
- Do not take the vehicle through an automatic car wash whilst the compact spare tyre is installed.
- Do not use tyre chains on the temporary compact tyre. Because of the smaller size, a tyre chain will not fit properly. This could damage the vehicle and result in loss of the chain.
- Temporary compact tyre should not be installed on the front axle if the vehicle must be driven in snow or on ice.
- Do not use the temporary compact tyre on any other vehicle because this tyre has been designed especially for your vehicle.
- The temporary compact tyre tread life is shorter than a regular tyre. Inspect your temporary compact tyre regularly and replace worn compact spare

### If you have a flat tyre (with spare tyre)

- tyres with the same size and design, mounted on the same wheel.
- The temporary compact tyre should not be used on any other wheels, nor should standard tyres, snow tyres, wheel covers or trim rings be used with the temporary compact spare wheel. If such use is attempted, damage to these items or other car components may occur.
- Do not use more than one temporary compact tyre at a time.
- Do not tow a trailer whilst the temporary compact tyre is installed.

Jack label

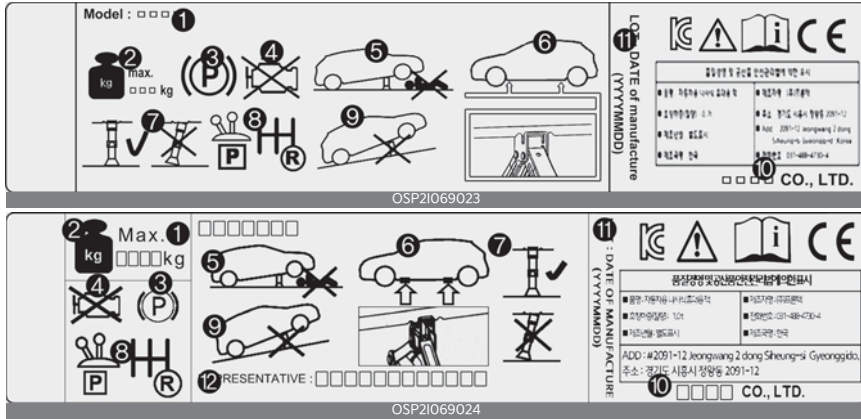

\* The actual jack label in the vehicle may differ from the illustration. For more detailed specifications, refer to the label attached to the jack.

1. Jack type
2. Maximum allowable load
3. When using the jack, set your parking brake.
4. When using the jack, stop the engine.
5. Do not get under a vehicle that is supported by a jack.
6. The designated locations under the frame
7. When supporting the vehicle, the base plate of jack must be vertical under the lifting point.
8. Move the shift lever to the P position on vehicles with intelligent variable transmission.
9. The jack should be used on firm level ground.
10. Jack manufacturer
11. Production date
12. Representative company and address



7

What to do in an emergency

If you have a flat tyre (with spare tyre)

## EC Declaration of conformity Jack

**SATHYA AUTO PRIVATE LIMITED**   
Works / Regd. Office : Plant-I  
No. 133, SIDCO Industrial Estate, Thirumazhisai, Chennai - 600 124. Ph : +91 44 26810211

---

**CE**

EC Declaration of Conformity  
according to EC Machinery Directive 2006/42/EC

**Ww:** SATHYA AUTO PRIVATE LTD.  
133, SIDCO INDUSTRIAL ESTATE, CHENNAI PINCODE: 600124, TAMIL NADU, INDIA.  
declare under our sole responsibility that the product

**Product** : JACK-ASSY  
**Type Designation(s)** : 700KG, 800KG, 1000KG  
**Serial No.** : N/A (prototype)  
**Year of Manufacture** : 2013

to which this declaration relates is in conformity with the following standard(s) or other normative document(s):

**EN ISO12100** Safety of machinery – General principles for design – Risk assessment and risk reduction (2010)  
**EN ISO12100-2A1** Safety of Machinery – Basic concepts, general principles for design, Part 2: Technical principles (2009)  
**EN 1484A1** Mobile or movable jacks and associated lifting equipment (2008)

Following the provisions of Directives:

**2006/42/EC** Directive on the approximation of the laws of Member States relating to machinery (OJ L157 Jun. 8, 2006)

Sathyas Auto Private Limited, Chennai, India / 21.8.2013 B.MOCHAN, Managing Director  
(Place and date of issue) (Name and signature or equivalent marking of Authorized person)

- **T.C.F. Compiling Person:** GS Zurich AG,
- **P.O. Box:** 8335, CH-8080 Zurich

<b>Works : Plant-II</b> No. 14, SIDCO Industrial Estate, Thirumazhisai, Chennai - 600 124, Ph : +91 44 26810212	<b>Works : Plant-III</b> S.No. 856/2, Village No. 124/230, Rupasam Nagar, Maggadu B Village, Thiruvallur Taluk & Dist., Tamilnadu.
Tel/fax : +91 44 26810211/216	Website : www.sathyasauto.com E-mail : info@sathyasauto.com

OSP21069021

## Towing

### Towing service

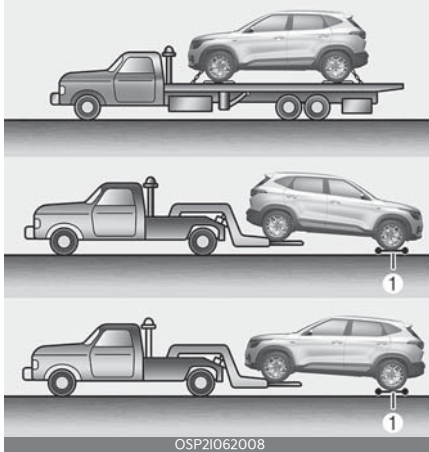

1 : dollies

If emergency towing is necessary, we recommend having it done by an authorised Kia dealer or a commercial tow-truck service. Proper lifting and towing procedures are necessary to prevent damage to the vehicle. The use of wheel dollies (1) or flatbed is recommended.

It is acceptable to tow the vehicle with the rear wheels on the ground (without dollies) and the front wheels off the ground.

If any of the loaded wheels or suspension components are damaged or the vehicle is being towed with the front wheels on the ground, use a towing dolly under the front wheels.

When being towed by a commercial tow truck and wheel dollies are not used, the front of the vehicle should always be lifted, not the rear.

### CAUTION



- Do not tow the vehicle backwards with the front wheels on the ground as this may cause damage to the vehicle.
- Do not tow with sling-type equipment. Use wheel lift or flatbed equipment.
- Do not tow the vehicle with four wheels in contact with the ground if it is the vehicle equipped with IVT or AT. Otherwise, the transmission will be seriously damaged. Also, make sure not to tow the vehicle connecting it with other vehicles including camper vans.

When towing your vehicle in an emergency without wheel dollies:

1. Set the ignition switch in the ACC position.



2. Place the transmission shift lever in N (Neutral).
3. Release the parking brake.

**⚠ CAUTION**

Failure to place the transmission shift lever in N (Neutral) may cause internal damage to the transmission.

**Removable towing hook**

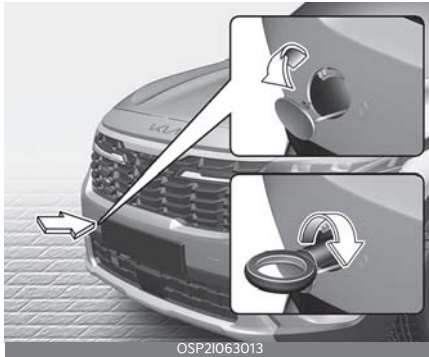
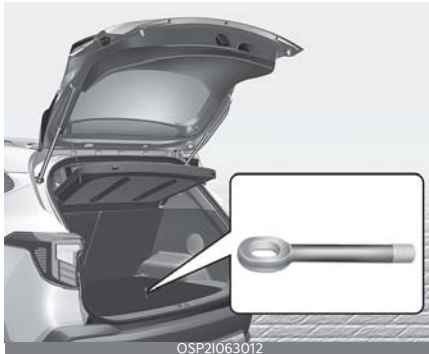

1. Open the tailgate, and remove the towing hook from the tool case.
2. Remove the hole cover pressing the lower part of the cover on the bumper.
3. Install the towing hook by turning it clockwise into the hole until it is fully secured.

4. Remove the towing hook and install the cover after use.

**Emergency towing**

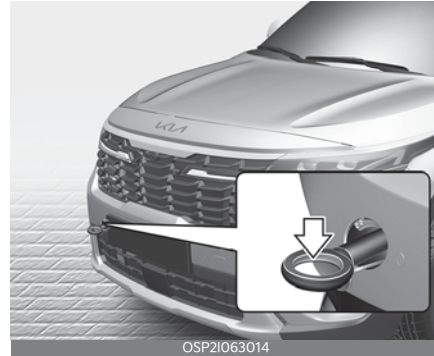

**If towing is necessary, we recommend you to have it done by an authorised Kia dealer or a commercial tow truck service.**

If towing service is not available in an emergency, your vehicle may be temporarily towed using a cable or chain secured to the emergency towing hook under the front (or rear) of the vehicle. Use extreme caution when towing the vehicle. A driver must be in the vehicle to steer it and operate the brakes.

Towing in this manner may be done only on hard-surfaced roads for a short distance and at low speed. Also, the wheels,

axles, power train, steering and brakes must all be in good condition.

- Do not use the tow hooks to pull a vehicle out of mud, sand or other conditions from which the vehicle cannot be driven out under its own power.
- Avoid towing a vehicle heavier than the vehicle doing the towing.
- The drivers of both vehicles should communicate with each other frequently.

**⚠ CAUTION**

- Attach a towing strap to the tow hook.
- Using a portion of the vehicle other than the tow hooks for towing may damage the body of your vehicle.
- Use only a cable or chain specifically intended for use in towing vehicles. Securely fasten the cable or chain to the towing hook provided.
- Accelerate or decelerate the vehicle in a slow and gradual manner whilst maintaining tension on the tow rope or chain to start or drive the vehicle, otherwise tow hooks and the vehicle may be damaged.

- Before emergency towing, check if the hook is not broken or damaged.
- Fasten the towing cable or chain securely to the hook.
- Do not jerk the hook. Apply it steadily and with even force.
- To avoid damaging the hook, do not pull from the side or at a vertical angle. Always pull straight ahead.

**⚠ WARNING**

Use extreme caution when towing the vehicle.

- Avoid sudden starts or erratic driving manoeuvres which would place

excessive stress on the emergency towing hook and towing cable or chain. The hook and towing cable or chain may break and cause serious injury or damage.

- If the disabled vehicle is unable to be moved, do not forcibly continue the towing. We recommend that you contact an authorised Kia dealer or a commercial tow truck service for assistance.
  - Tow the vehicle as straight ahead as possible.
  - Keep away from the vehicle during towing.
- 
- Use a towing strap less than 5 m (16 feet) long. Attach a white or red cloth (about 30 cm (12 inches) wide) in the middle of the strap for easy visibility.

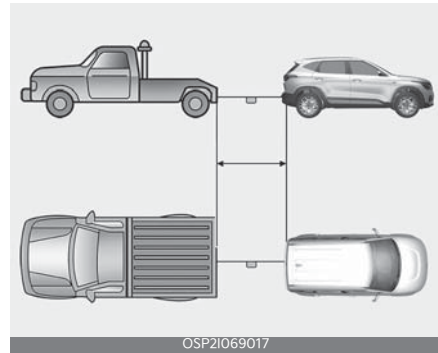
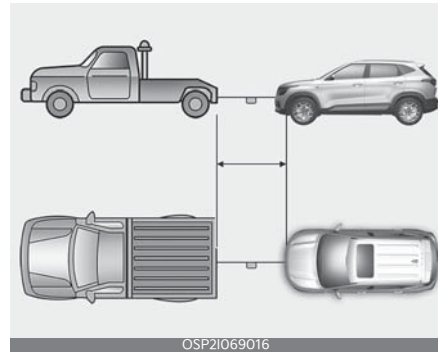

- Drive carefully so that the towing strap is not loosened during towing.
- The driver must be in the vehicle for steering and braking operations when the vehicle is towed and passengers other than the driver must not be allowed to be on board.

### Emergency towing precautions

- Turn the ignition switch to ACC so the steering wheel isn't locked.
- Place the transmission shift lever in N (Neutral).
- Release the parking brake.
- Press the brake pedal with more force than normal since you will have reduced brake performance.
- More steering effort will be required because the power steering system will be disabled.
- If you are driving down a long hill, the brakes may overheat and brake performance will be reduced. Stop often and let the brakes cool off.
- The vehicle should be towed at a speed of 25 km/h (15 mph) or less within the distance of 20 km (12 miles). (For Manual transmission and Intelligent Manual Transmission vehicle)
- To avoid serious damage to the automatic transmission, limit the vehicle speed to 15 km/h (10 mph) and drive less than 1.5 km (1 mile) when towing. (for Automatic Transmission and Intelligent Variable Transmission vehicle and Dual Clutch Transmission)

### **⚠ CAUTION**

#### **Automatic transmission/Intelligent variable transmission**

- If the car is being towed with all four wheels on the ground, it can be towed

only from the front. Be sure that the transmission is in neutral. Be sure the steering is unlocked by placing the ignition switch in the ACC position. A driver must be in the towed vehicle to operate the steering and brakes.

- Before towing, check the automatic transmission/intelligent variable transmission for fluid leaks under your vehicle. If the automatic transmission/intelligent variable transmission fluid is leaking, flatbed equipment or a towing dolly must be used.

## Emergency commodity (if equipped)

There are some emergency commodities in the vehicle to help you respond to the emergency situation.

### First aid kit

There are some items such as bandage and adhesive tape and etc. in the kit to give first aid to an injured person.

### Triangle reflector

Place the triangle reflector on the road to warn oncoming vehicles during emergencies, such as when the vehicle is parked by the roadside due to any problems.

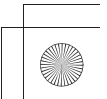
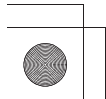
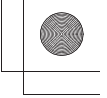
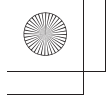

# Maintenance 8

<b>Engine compartment</b> .....	<b>8-4</b>
<b>Maintenance services</b> .....	<b>8-7</b>
<b>Owner maintenance</b> .....	<b>8-8</b>
<b>Scheduled maintenance service</b> .....	<b>8-10</b>
<b>Explanation of scheduled maintenance items</b> .....	<b>8-15</b>
<b>Engine oil and filter (for petrol)</b> .....	<b>8-19</b>
• Checking the engine oil level.....	8-19
• Changing the engine oil and filter .....	8-20
<b>Engine oil (for diesel)</b> .....	<b>8-22</b>
• Checking the engine oil level.....	8-22
• Changing the engine oil and filter .....	8-23
<b>Engine coolant</b> .....	<b>8-24</b>
• Checking the coolant level.....	8-25
• Changing the coolant.....	8-27
<b>Intelligent Manual Transmission (iMT) system actuator fluid</b> .....	<b>8-27</b>
• Checking the iMT system actuator fluid level.....	8-27
<b>Brake/clutch fluid</b> .....	<b>8-28</b>
• Checking the brake/clutch fluid level.....	8-28
<b>Washer fluid</b> .....	<b>8-29</b>
• Checking the washer fluid level.....	8-29
<b>Parking brake</b> .....	<b>8-30</b>
• Checking the parking brake.....	8-30
<b>Fuel Filter (for diesel)</b> .....	<b>8-31</b>
• Draining water from the fuel filter.....	8-31
• Fuel filter cartridge replacement.....	8-31
<b>Air cleaner filter</b> .....	<b>8-32</b>
• Replacing air cleaner filter .....	8-32

# 8 Maintenance

<b>Climate control air filter</b> .....	<b>8-33</b>
• Inspecting and replacing climate control air filter.....	8-33
<b>Wiper blades</b> .....	<b>8-34</b>
• Front windscreen wiper blade.....	8-35
• Replacing front windscreen wiper blade.....	8-35
• Replacing rear window wiper blade.....	8-35
<b>Battery</b> .....	<b>8-36</b>
<b>Tyres and wheels</b> .....	<b>8-39</b>
• Checking tyre inflation pressure.....	8-40
• Tyre rotation.....	8-41
• Wheel alignment and tyre balance.....	8-41
• Tyre replacement.....	8-41
• Compact spare tyre replacement.....	8-42
• Wheel replacement.....	8-42
• Tyre traction.....	8-42
• Tyre maintenance.....	8-43
• Tyre sidewall labeling.....	8-43
• Tyre terminology and definitions.....	8-45
• All season tyres.....	8-47
• Summer tyres.....	8-47
• Snow tyres.....	8-48
• Tyre chains.....	8-48
• Radial-ply tyres.....	8-48
• Low aspect ratio tyre.....	8-49
<b>Fuses</b> .....	<b>8-50</b>
• Replacing inner panel fuse.....	8-52
• Replacing engine compartment fuse.....	8-52
<b>Light bulbs</b> .....	<b>8-60</b>
• Headlamp bulb.....	8-64
• Replacing headlamp (low/high) / turn signal lamp / position lamp / daytime running lamp bulb (bulb type) (headlamp type A).....	8-65

# Maintenance 8

- Replacing headlamp (low/high) / turn signal lamp bulb (bulb type) (headlamp type B)..... 8-66
- Replacing position lamp / daytime running lamp (LED type) (headlamp type B)..... 8-66
- Replacing headlamp (high and low) / position lamp / daytime running lamp / turn signal lamp (LED type) (headlamp type C) ..... 8-66
- Replacing position lamp (auxiliary) (LED type).....8-67
- Replacing front fog lamp (bulb/LED type).....8-67
- Replacing side repeater lamp (LED Type) bulb..... 8-68
- Replacing side repeater lamp bulb (bulb type) ..... 8-68
- Replacing rear turn signal lamp / tail and stop lamp bulb (bulb type) (rear combination lamp type A, B)..... 8-69
- Replacing stop / tail (LED type) rear combination lamp type B ..... 8-69
- Replacing stop lamp (LED type), Tail (LED type) & T/Sig (LED type) in Rear Combination lamp type C..... 8-70
- Replacing High Mounted Stop Lamp bulb (bulb type) ..... 8-70
- Replacing license plate lamp bulb.....8-71
- Replacing B/Up Lamp in Type A & Type B ..... 8-71
- Replacing map lamp (bulb type) bulb ..... 8-71
- Replacing map lamp (LED type) bulb.....8-72
- Replacing room lamp (bulb type) bulb .....8-72
- Replacing room lamp (LED type) bulb .....8-72
- Replacing luggage room lamp (bulb type) bulb .....8-73
- Appearance care.....8-74**
- Exterior care ..... 8-74
- Interior care ..... 8-78
- Emission control system ..... 8-81**
- Lean NOx Trap..... 8-84
- Self Regeneration Mode ..... 8-84



## Maintenance

### Engine compartment

Open the bonnet to see the engine compartment.

Smartstream G1.5

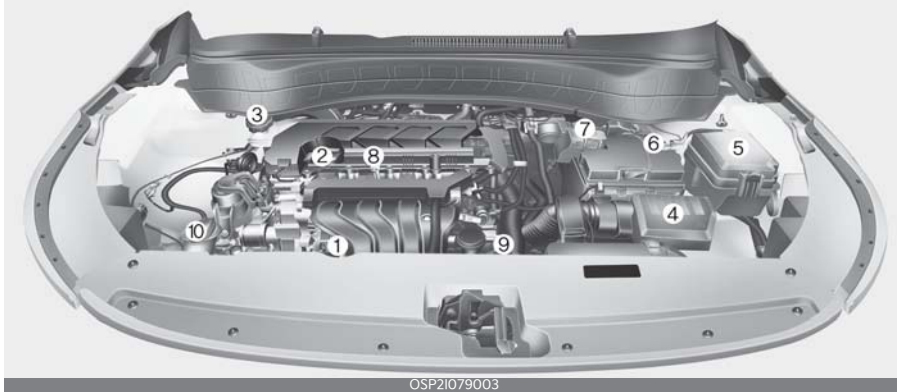

\* The actual engine room in the vehicle may differ from the illustration.

1. Engine coolant reservoir
2. Engine oil filler cap
3. Brake/clutch fluid reservoir
4. Air cleaner
5. Fuse box
6. Negative battery terminal
7. Positive battery terminal
8. Engine oil dipstick
9. Radiator cap
10. Windscreen washer fluid reservoir

## Smartstream G1.5 T-GDi



\* The actual engine room in the vehicle may differ from the illustration.

1. Engine coolant reservoir	8-24
2. Engine oil filler cap	8-19
3. Brake/clutch fluid reservoir	8-28
4. Air cleaner	8-32
5. Fuse box	8-52
6. Negative battery terminal	7-5, 8-36
7. Positive battery terminal	7-5, 8-36
8. Engine oil dipstick	8-22
9. Radiator cap	7-7, 8-24
10. Windscreen washer fluid reservoir	8-29

(Diesel) 1.5 VGT

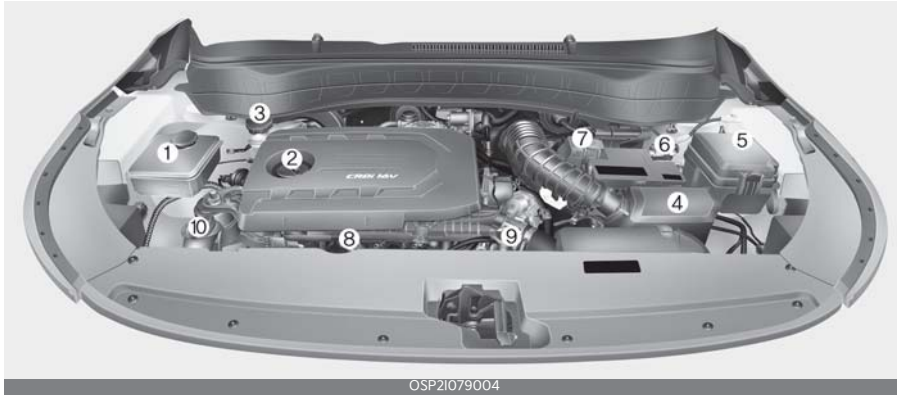

\* The actual engine room in the vehicle may differ from the illustration.

1. Engine coolant reservoir	8-24
2. Engine oil filler cap	8-19
3. Brake/clutch fluid reservoir	8-28
4. Air cleaner	8-32
5. Fuse box	8-52
6. Negative battery terminal	7-5, 8-36
7. Positive battery terminal	7-5, 8-36
8. Engine oil dipstick	8-22
9. Radiator cap	7-7, 8-24
10. Windscreen washer fluid reservoir	8-29

## Maintenance services

You should exercise the utmost care to prevent damage to your vehicle and injury to yourself whenever performing any maintenance or inspection procedures.

Should you have any doubts concerning the inspection or servicing of your vehicle, we strongly recommend that you have an authorised Kia dealer perform this work.

An authorised Kia dealer has factory-trained technicians to service your vehicle properly. For expert advice and quality service, see an authorised Kia dealer. Inadequate, incomplete or insufficient servicing may result in operational problems with your vehicle that could lead to vehicle damage, an accident, or personal injury.

## Owner's responsibility

### \* NOTICE

Maintenance Service and Record Retention are the owner's responsibility.

You should retain documents that show proper maintenance has been performed on your vehicle in accordance with the scheduled maintenance service charts shown on the following pages.

You need this information to establish your compliance with the servicing and maintenance requirements of your vehicle warranties.

Detailed warranty information is provided in your Warranty & Consumer Information manual.

Repairs and adjustments required as a result of improper maintenance or a lack of required maintenance are not covered.

We recommend you have your vehicle maintained and repaired by an authorised Kia dealer/service partner. Authorised Kia dealers meet Kia's high service quality standards and receive technical support from Kia in order to provide you with a high level of service satisfaction.

## Owner maintenance precautions

Improper or incomplete service may result in problems. This section gives instructions only for the maintenance items that are easy to perform.

As explained earlier in this section, several procedures can be done only by an authorised Kia dealer with special tools.

### \* NOTICE

Improper owner maintenance during the warranty period may affect warranty coverage. For details, read the separate Warranty & Consumer Information manual provided with the vehicle. If you're unsure about any servicing or maintenance procedure, we recommend that the system be serviced by a professional workshop. Kia recommends to visit an authorised Kia dealer/service partner.

### ▲ WARNING

## Maintenance work

Do not wear jewelry or loose clothing whilst working under the bonnet of your vehicle with the engine running. These items can become entangled in moving parts, if you must run the engine whilst working under the bonnet, make certain that you remove all jewelry (especially rings, bracelets, watches, and necklaces) and all neckties, scarves, and similar loose clothing before getting near cooling fans.

**⚠ WARNING****Touching metal parts**

Do not touch metal parts (including strut bars) whilst the vehicle is operating or hot. Doing so could result in serious bodily injury. Turn the vehicle off and wait until the metal parts cool down to perform maintenance work on the vehicle.

---

**Owner maintenance**

The following lists detail the vehicle checks and inspections that should be performed by the owner or an authorised Kia dealer. They should be performed at the indicated frequencies to help ensure the safe and dependable operation of your vehicle.

Any adverse conditions should be brought to the attention of your dealer as soon as possible.

These owner maintenance checks are generally not covered by warranties and you may be charged for labour, parts and lubricants used.

**When you stop for fuel:**

- Check the coolant level in coolant reservoir.
- Check the windscreen washer fluid level.
- Look for low or under-inflated tyres.
- Check if the front of the radiator and condenser are clean and not blocked with leaves, dirt or insects etc. If any of the above parts are extremely dirty or you are not sure of their condition, we recommend that you contact a professional workshop. Kia recommends to visit an authorised Kia dealer/service partner.

**⚠ WARNING****Hot coolant**

Be careful when checking your engine coolant level when the engine is hot. Scalding hot coolant and steam may blow out under pressure.

---

**Whilst operating your vehicle:**

- Check for vibrations in the steering wheel. Notice any increased steering effort or looseness in the steering wheel, or change in its straight-ahead position.
- Notice if your vehicle constantly turns slightly or "pulls" to one side when travelling on smooth, level road.
- When stopping, listen and check for unusual sounds, pulling to one side, increased brake pedal travel or "hard-to-push" brake pedal.
- If any slipping or changes in the operation of your transmission occurs, check the transmission fluid level.
- Check the Intelligent Variable Transmission (IVT) P (Park) function.
- Check the parking brake.
- Check for fluid leaks under your vehicle (water dripping from the air conditioning system during or after use is normal).

**At least monthly:**

- Check the coolant level in the coolant reservoir.
- Check the operation of all exterior lights, including the stoplights, turn signals and hazard warning flashers.
- Check the inflation pressures of all tyres including the spare for tyres that are worn, show uneven wear, or are damaged.
- Check for loose wheel lug nuts.

**At least twice a year (i.e., every Spring and Fall):**

- Check the radiator, heater and air conditioning hoses for leaks or damage.
- Check the windscreen washer spray and wiper operation. Clean the wiper blades with clean cloth dampened with washer fluid.
- Check the headlight alignment.
- Check the lap/shoulder belts for wear and function.

**At least once a year:**

- Clean the body and door drain holes.
- Lubricate the door hinges and check the bonnet hinges.
- Lubricate the door and bonnet locks and latches.
- Lubricate the door rubber weatherstrips.
- Check the air conditioning system.
- Inspect and lubricate Intelligent Variable Transmission (IVT) linkage and controls.
- Clean the battery and terminals.
- Check the brake/clutch fluid level.
- Visually inspect steering, suspension, and chassis components for damaged, loose, or missing parts or signs of wear.

## Scheduled maintenance service

Follow the Normal maintenance schedule if the vehicle is usually operated where none of the following conditions apply.

Follow the Maintenance Under Severe Usage Conditions if any of the following conditions apply.

- Repeated driving short distance of less than 8 km (5 miles) in normal temperature or less than 16 km (10 miles) in freezing temperature.
- Extensive engine idling or low speed driving for long distances.
- Driving on rough, dusty, muddy, unpaved, graveled or salt-spread roads.
- Driving in areas using salt or other corrosive materials or in very cold weather.
- Driving in heavy dust condition.
- Driving in heavy traffic area.
- Driving on uphill, downhill, or mountain road repeatedly.
- Using for towing or camping and driving with loading on the roof.
- Driving for patrol car, taxi, other commercial use of vehicle towing.
- Frequently driving under high speed or rapid acceleration/deceleration.
- Frequently driving in stop-and-go condition.
- Engine oil usage which is not recommended (Mineral type, Semi-synthetic, Lower grade spec, etc.)

If your vehicle is operated in any of the prior listed conditions, you should inspect, replace or refill more frequently, using the severe usage maintenance

schedule instead of the normal usage maintenance schedule.

## Normal maintenance schedule

The following maintenance services must be performed to ensure good emission control and performance. Keep receipts for all vehicle emission services to protect your warranty. Where both mileage and time are shown, the frequency of service is determined by whichever occurs first.

No.	Item	Remark
*1	Engine oil and engine oil filter	<ul style="list-style-type: none"> <li>As it is normal for engine oil to be consumed during driving, the engine oil level should be checked on regular basis.</li> <li>The engine oil change interval for normal operating conditions is based on the use of the recommended engine specification. If the recommended engine oil specification is not used, then replace the engine oil according to the maintenance schedule under severe operating conditions.</li> <li>Never add any additives to the engine oil. Engine oil additives can change the properties of engine oil and may cause serious engine failure.</li> </ul>
*2	Coolant (Engine)	When adding coolant, use only deionized water or soft water for your vehicle and never mix hard water in the coolant filled at the factory. An improper coolant mixture can result in serious malfunction or engine damage.
*3	Drive belts (Engine)	<ul style="list-style-type: none"> <li>Adjust alternator, water pump and air conditioner (if equipped) drive belt. Inspect and if necessary repair or replace.</li> <li>Inspect drive belt tensioner, idler and alternator pulley and if necessary correct or replace.</li> </ul>
*4	Spark plug	For your convenience, it can be replaced prior to its interval when you do maintenance of other items.
*5	Fuel filter cartridge (Diesel)	This maintenance schedule depends on fuel quality. It is applicable only when using a qualified fuel <"EN590 or equivalent">. If the diesel fuel specifications don't meet the EN590, it must be replaced more frequently. Kia recommends "every 7,500 km (5,000 miles) inspection, every 15,000 km (10,000 miles) replacement". If there are some important safety matters like fuel flow restriction, surging, loss of power, hard starting problem etc., replace the fuel filter immediately regardless of maintenance schedule and consult a professional workshop. Kia recommends to consult an authorised Kia dealer/service partner.
*6	Engine oil and engine oil filter (For Diesel Engine)	<ul style="list-style-type: none"> <li>The engine oil level should be checked regularly and maintained properly. Operating with an insufficient amount oil can damage the engine, and such damage is not covered by warranty.</li> <li>This maintenance schedule depends on fuel quality. It is applicable only when using a qualified fuel &lt;"EN590 or equivalent"&gt;. If the diesel fuel specifications don't meet the EN590, it must be replaced according to the severe maintenance schedule.</li> </ul>
*	Transmission fluid	Transmission fluid should be changed anytime it has been submerged in water.



## Normal maintenance schedule

The following maintenance services must be performed to ensure good emission control and performance. Keep receipts for all vehicle emission services to protect your warranty. Where both mileage and time are shown, the frequency of service is determined by whichever occurs first.

I: Inspect and if necessary, adjust, correct, clean or replace.

R: Replace or change

		Number of months or driving distance, whichever comes first									
Months		1.5	12	24	36	48	60	72	84	96	
Km X 1,000		1	10	20	30	40	50	60	70	80	
Engine oil and engine oil filter <sup>1,2</sup>	Petrol, Smartstream G1.5 & G1.5 T-GDi	I	R	R	R	R	R	R	R	R	
	(Diesel) 1.5 VGT <sup>6</sup>										
Coolant (Engine) <sup>3</sup>	Petrol, Diesel	At first, replace at 100,000 km or 60 months: After that, replace every 20,000 km or 24 months									
Drive belts (Engine) <sup>4</sup>	Petrol	-	-	I	-	I	-	I	-	I	
	Diesel	-	-	-	-	I	I	I	I	I	
Vacuum hoses and crankcase ventilation hoses	Petrol, Diesel	-	I	I	I	I	I	I	I	I	
Spark plugs	Petrol	Smartstream G1.5	Replace every 150,000 km								
		Smartstream G1.5 T-GDi	Replace every 70,000 km								
Automatic transmission fluid (if equipped)	Diesel	At first, replace at 110,000 km, after that, replace every 100,000 km.									
Dual clutch transmission (DCT) fluid	Petrol, Smartstream 1.5 T-GDi	No check, No service required									
Intelligent variable transmission (IVT) fluid (if equipped)	Petrol	No check, No service required									
Manual transmission fluid (if equipped)	Petrol, Diesel	-	-	-	-	-	-	I	-	-	
Intelligent manual transmission (iMT) fluid (if equipped)	Petrol, Diesel	-	-	-	-	-	-	I	-	-	
Intelligent manual transmission (iMT) system clutch actuator fluid (if equipped)	Petrol, Diesel	-	I	R	I	R	I	R	I	R	
Intelligent manual transmission (iMT) system clutch tube and line (if equipped)	Petrol, Diesel	-	I	I	I	I	I	I	I	I	
Drive shaft and boots	Petrol, Diesel	I	I	I	I	I	I	I	I	I	
Fuel lines, hoses and connections	Petrol	I	I	I	I	I	I	I	I	I	
	Diesel										
Fuel tank air filter	Petrol	Replace every 120 months or 160,000 km									

		Number of months or driving distance, whichever comes first								
Months		1.5	12	24	36	48	60	72	84	96
Km X 1,000		1	10	20	30	40	50	60	70	80
Fuel filter	Petrol	-	-	I	-	R	-	I	-	R
Vapour hose and fuel filler cap	Petrol	-	-	-	-	I	-	-	-	I
Fuel filter cap	Diesel	-	-	-	-	I	-	-	-	I
Fuel filter cartridge <sup>6</sup>	Diesel	-	I	R	I	R	I	R	I	R
Intercooler, in/out hose, air intake hose	Petrol, Smartstream 1.5 T-GDi	-	I	I	I	I	I	I	I	I
Air cleaner filter	Petrol, Diesel	-	I	R	I	R	I	R	I	R
Exhaust system	Petrol, Diesel	I	I	I	I	I	I	I	I	I
Cooling system	Petrol, Diesel	I	I	I	I	I	I	I	I	I
Air conditioner compressor/refrigerant (if equipped)	Petrol, Diesel	-	I	I	I	I	I	I	I	I
Climate control air filter (if equipped)	Petrol, Diesel	-	I	R	I	R	I	R	I	R
Brake discs, pads and calipers	Petrol, Diesel	-	I	I	I	I	I	I	I	I
Brake lines, hoses and connections	Petrol, Diesel	I	I	I	I	I	I	I	I	I
Brake/clutch fluid	Petrol, Diesel	I	I	I	R	I	I	R	I	I
Parking brake	Petrol, Diesel	I	I	I	I	I	I	I	I	I
Steering gear rack, linkage and boots	Petrol, Diesel	I	I	I	I	I	I	I	I	I
Suspension ball joints	Petrol, Diesel	I	I	I	I	I	I	I	I	I
Tyre (pressure & tread wear)	Petrol, Diesel	I	I	I	I	I	I	I	I	I
Battery (12V) condition	Petrol, Diesel	I	-	I	-	I	-	I	-	I
Urea solution line & connections	Diesel	-	-	I	-	I	-	I	-	I
Urea solution filler cap	Diesel	-	-	I	-	I	-	I	-	I
Throttle body	Petrol	-	Inspect and clean if required							
All electrical systems	Petrol, Diesel	I	I	I	I	I	I	I	I	I
Brake pedal, clutch pedal	Petrol, Diesel	I	I	I	I	I	I	I	I	I
Bolt and nuts on chassis and body	Petrol, Diesel	I	I	I	I	I	I	I	I	I
Wheel alignment & balancing	Petrol, Diesel	-	I	I	I	I	I	I	I	I
Warning lights operation & KDS system check	Petrol, Diesel	I	I	I	I	I	I	I	I	I
Road test	Petrol, Diesel	Inspect if required								

- Fuel filter (Petrol engine): The fuel filter is considered to be maintenance free but periodic inspection is recommended for this maintenance schedule depends on fuel quality.

## Maintenance Under Severe Usage Conditions

The following items must be serviced more frequently on cars mainly used under severe driving conditions. Refer to the chart below for the appropriate maintenance intervals.

R: Replace

I: Inspect and if necessary, adjust, correct, clean or replace

Maintenance item		Maintenance operation	Maintenance intervals	Driving condition
Engine oil and engine oil filter	Smartstream G1.5, G1.5T-GDi	R	Every 5,000 km (3,000 miles) or 6 months	A, B, C, D, E, F, G, H, I, J, K, L
	(Diesel) 1.5 VGT	R		A, B, C, D, E, F, G, H, I, J, K, M
Air cleaner filter		R	More frequently	C, E
Spark plugs		R	More frequently	A, B, F, G, H, I, K
Automatic transmission fluid (if equipped)		R	Every 90,000 km (60,000 miles)	A, C, F, G, H, I, J, K
Manual transmission fluid (if equipped)		R	Every 120,000 km (80,000 miles)	C, D, F, G, H, I, J
Dual clutch transmission (DCT) fluid		R	Every 120,000 km (80,000 miles)	C, D, F, G, H, I, J
Intelligent manual transmission (iMT) (if equipped)		R	Every 120,000 km (80,000 miles)	C, D, F, G, H, I, J
Intelligent variable transmission (iVT) fluid (if equipped)		R	Every 90,000 km (60,000 miles)	A, C, F, G, H, I, J, K
Brake discs, pads and calipers		I	More frequently	C, D, E, G, H, I, J, K
Parking brake		I	More frequently	C, D, G, H
Steering gear rack, linkage and boots		I	More frequently	C, D, E, F, G
Suspension ball joints and mounting bolts		I	More frequently	C, D, E, G, H, I
Drive shafts and boots		I	More frequently	C, D, E, F, G, H, I, J
Climate control air filter		I	More frequently	C, E, G

### Severe Driving Conditions

A: Repeatedly driving short distance of less than 8 km (5 miles) in normal temperature or less than 16 km (10 miles) in freezing temperature.

B: Extensive engine idling or low speed driving for long distances.

C: Driving on rough, dusty, muddy, unpaved, graveled or salt-spread roads.

D: Driving in areas using salt or other corrosive materials or in very cold weather.

E: Driving in heavy dust condition.

F: Driving in heavy traffic area.

G: Driving on uphill, downhill, or mountain roads repeatedly.

H: Using for towing or camping and driving with loading on the roof.

I: Driving for patrol car, taxi, other commercial use of vehicle towing.

J: Frequently driving under high speed or rapid acceleration/deceleration.

K: Frequently driving in stop-and-go conditions.

L: Engine oil usage which is not recommended (Mineral type, Semi-synthetic, Lower grade spec, etc.)

### Fuel lines, fuel hoses and connections

Check the fuel lines, fuel hoses and connections for leakage and damage. We recommend that the fuel lines, fuel hoses and connections be replaced by a professional workshop. Kia recommends to visit an authorised Kia dealer/service partner.

#### WARNING

##### Diesel only

Never work on the injection system with the engine running or within 30 seconds after shutting off the engine. High pressure pump, rail, injectors and high pressure pipes are subject to high pressure even after the engine stops. The fuel jet produced by fuel leaks may cause serious injury, if it touches the body. People wearing a cardiac pacemaker should maintain a distance of at least 30 cm from the ECU or wiring harness within the engine room whilst the engine is running, since the high currents in the Common Rail system produce considerable magnetic fields.

### Vapour hose and fuel filler cap (for petrol engine)

The vapour hose and fuel filler cap should be inspected at those intervals specified in the maintenance schedule. Make sure that a new vapour hose or fuel filler cap is correctly replaced.

### Vacuum crankcase ventilation hoses

Inspect the surface of hoses for evidence of heat and/or mechanical damage. Hard and brittle rubber, cracking, tears, cuts, abrasions, and excessive swelling indicate deterioration. Particular attention should be paid to examine those hose surfaces nearest to high heat sources, such as the exhaust manifold. Inspect the hose routing to assure that the hoses do not come in contact with any heat source, sharp edges or moving components which might cause heat damage or mechanical wear. Inspect all hose connections, such as clamps and couplings, to make sure they are secure, and that no leaks are present. Hoses should be replaced immediately if there is any evidence of deterioration or damage.

### Air cleaner filter

We recommend that the air cleaner filter be replaced by a professional workshop. Kia recommends to visit an authorised Kia dealer/service partner.

### Spark plugs

Make sure to install new spark plugs of the correct heat range.

When assembling parts, be sure to wipe the inside and outside of the boot bottom of the ignition coil and the insulator

of the spark plug with a soft cloth to prevent contamination of the spark plug insulator.

### Cooling system

Check the cooling system components, such as the radiator, coolant reservoir, hoses and connections for leakage and damage. Replace any damaged parts.

### Coolant

The coolant should be changed at the intervals specified in the maintenance schedule.

### Manual transmission (MT) fluid (if equipped)

Inspect the manual transmission fluid according to the maintenance schedule.

### Intelligent manual transmission (iMT) system actuator fluid (if equipped)

Inspect the Intelligent manual transmission system actuator fluid according to the maintenance schedule.

### Dual clutch transmission (DCT) fluid (if equipped)

Inspect the dual clutch transmission fluid according to the maintenance schedule.

### Automatic transmission (AT) fluid (if equipped)

Automatic transmission (AT) fluid should not be checked under normal usage conditions. Have the Automatic transmission (AT) fluid changed by a professional workshop according to the maintenance schedule. Kia recommends

to visit an authorised Kia dealer/service partner.

#### \* NOTICE

Automatic transmission (AT) fluid colour is basically red.

As the vehicle is driven, the Automatic transmission (AT) fluid will begin to look darker. It is normal condition and you should not judge the need to replace the fluid based upon the changed colour.

#### ▲ CAUTION

The use of a non-specified fluid could result in transmission malfunction and failure.

Use only specified Automatic transmission (AT) fluid. (Refer to "Recommended lubricants and capacities" on page 9-10.)

### Intelligent Variable Transmission (IVT) fluid (if equipped)

Intelligent Variable Transmission (IVT) fluid should not be checked under normal usage conditions. But in severe conditions, the fluid should be changed at an authorised Kia dealer in accordance to the scheduled maintenance at the beginning of this section.

We recommend that the Intelligent Variable Transmission fluid (IVT) be changed by an authorised Kia dealer according to the maintenance schedule.

#### \* NOTICE

Intelligent Variable Transmission (IVT) fluid colour is usually light amber. As the vehicle is driven, the Intelligent Variable Transmission (IVT) fluid will begin to look darker.

It is the normal condition and you should not judge the need to replace the fluid based upon the changed colour.

### CAUTION

#### Transmission fluids

The use of non-specified fluid (even marked as compatible with genuine) could result in shift quality deterioration and vibrations, eventually, the transmission failure. Use only specified Intelligent Variable Transmission (IVT) fluid. (Refer to "Recommended lubricants and capacities" on page 9-10)

#### Brake hoses and lines

Visually check for proper installation, chafing, cracks, deterioration and any leakage. Replace any deteriorated or damaged parts immediately.

#### Brake/clutch fluid

Check the brake/clutch fluid level in the brake/clutch fluid reservoir. The level should be between "MIN" and "MAX" marks on the side of the reservoir. Use only hydraulic brake/clutch fluid conforming to DOT 4 specification.

#### Parking brake

Inspect the parking brake system including the parking brake lever (or pedal) and cables.

#### Exhaust pipe and muffler

Visually inspect the exhaust pipes, muffler and hangers for cracks, deterioration, or damage. Start the engine and listen carefully for any exhaust gas leak-

age. Tighten connections or replace parts as necessary.

#### Brake discs, pads and calipers

Check the pads for excessive wear, discs for run out and wear, and calipers for fluid leakage.

For more information on checking the pads or lining wear limit, we recommend to refer to the Kia web site. (<http://www.kia-hotline.com>)

#### Suspension mounting bolts

Check the suspension connections for looseness or damage. Retighten to the specified torque.

#### Steering gear box, linkage & boots/lower arm ball joint

With the vehicle stopped and off, check for excessive free-play in the steering wheel.

Check the linkage for bends or damage. Check the dust boots and ball joints for deterioration, cracks, or damage. Replace any damaged parts.

#### Drive shafts and boots

Check the drive shafts, boots and clamps for cracks, deterioration, or damage. Replace any damaged parts and, if necessary, repack the grease.

#### Air conditioning refrigerant

Check the air conditioning lines and connections for leakage and damage.

#### Checking fluid levels

When checking engine oil, engine coolant, brake/clutch fluid, and washer fluid,

always be sure to clean the area around any filler plug, drain plug, or dipstick before checking or draining any lubricant or fluid. This is especially important in dusty or sandy areas and when the vehicle is used on unpaved roads. Cleaning the plug and dipstick areas will prevent dirt and grit from entering the engine and other mechanisms that could be damaged.

## Engine oil and filter (for petrol)

### Checking the engine oil level

Engine oil is used for lubricating, cooling, and operating various hydraulic components in the engine. Engine oil consumption whilst driving is normal, and it is necessary to check and refill the engine oil regularly. Also, check and refill the oil level within the recommended maintenance schedule to prevent deterioration of oil performance. Check the engine oil following the below procedure.

Smartstream G1.5

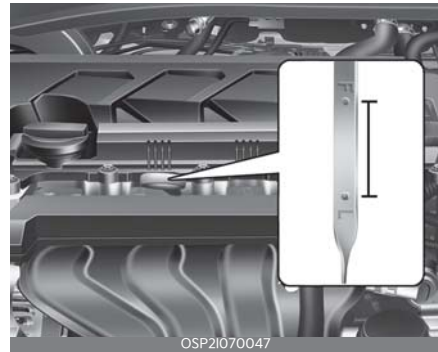

Smartstream G1.5 T-GDi

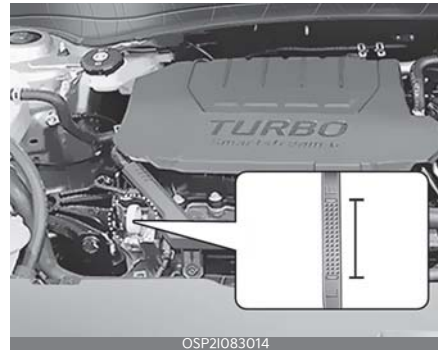

1. Be sure the vehicle is on level ground.
2. Start the engine and allow it to reach normal operating temperature.



3. Turn the engine off, remove the oil filler cap and pull the dipstick out. Wait for 15 minutes for the oil to return to the oil pan.
4. Wipe the dipstick clean and re-insert it fully.
5. Pull the dipstick out again and check the level. Check if the oil level is between the F-L line, and if it is below the L line, add enough oil to bring the level to F line.

#### **⚠ WARNING**

##### **Radiator hose**

Be very careful not to touch the radiator hose when checking or adding the engine oil as it may be hot enough to burn you.

#### **⚠ CAUTION**

When you wipe the oil level gauge, you should wipe it with a clean cloth. When mixed with debris, it can cause engine damage.

Smartstream G1.5

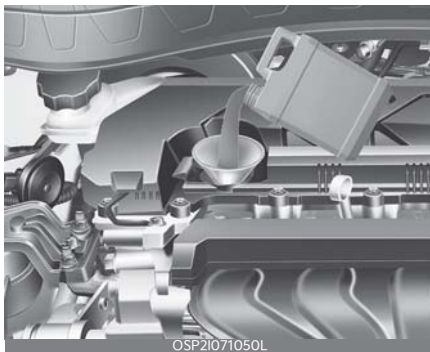

Smartstream G1.5 T-GDi



**Use a funnel to help prevent oil from being spilled on engine components.**

**Use only the specified engine oil.**

(Refer to "Recommended lubricants and capacities" on page 9-10.)

- Do not spill engine oil when adding or changing engine oil. Wipe off spilled oil immediately.
- The engine oil consumption may increase whilst you break in a new vehicle and it will be stabilized after driving 6,000 km (4,000 miles).
- The engine oil consumption can be affected by driving habits, climate conditions, traffic conditions, oil quality, etc. Therefore, it is recommended that you inspect the engine oil level regularly and refill it if necessary.

#### **Changing the engine oil and filter**

We recommend that the engine oil and filter be replaced by an authorised Kia dealer according to the Maintenance Schedule at the beginning of this chapter.

- If the maintenance schedule to replace engine oil is exceeded, the engine oil performance may deteriorate, and the engine condition may be affected. Therefore, replace the

engine oil according to the maintenance schedule.

- To keep the engine in optimal condition, use the recommended engine oil and filter. If the recommended engine oil and filter are not used replace it according to the maintenance schedule under severe usage conditions.
- The purpose of the maintenance schedule for engine oil replacement is to prevent oil deterioration and it is irrelevant to oil consumption. Check and refill engine oil regularly.

### **⚠ WARNING**

Used engine oil may cause irritation or cancer of the skin if left in contact with the skin for prolonged periods of time. Used engine oil contains chemicals that have caused cancer in laboratory animals. Always protect your skin by washing your hands thoroughly with soap and warm water as soon as possible after handling used oil. Do not leave used engine oil within the reach of children.

### **⚠ CAUTION**



The engine oil is very hot immediately after the vehicle has been driven and can cause burns during replacement. Replace the engine oil after the engine oil has cooled down.

### **\* NOTICE**

Never add any additives to the engine oil. Engine oil additives can change the properties of engine oil and may cause serious engine failure.

### **\* NOTICE**

#### **For Smartstream G1.5 T-GDi engine**

When the oil pressure is low due to insufficient engine oil, the Engine Oil Pressure () warning light will appear. In addition, the enhanced engine protection system, which limits the engine's power is activated and the Malfunction Indicator Lamp () will appear when the vehicle is driven in this state continuously.

When oil pressure is restored, the Engine Oil Pressure warning light will turn off and the engine power will no longer be limited.

## Engine oil (for diesel)

### Checking the engine oil level

Engine oil is used for lubricating, cooling, and operating various hydraulic components in the engine. Engine oil consumption whilst driving is normal, and it is necessary to check and refill the engine oil regularly. Also, check and refill the oil level within the recommended maintenance schedule to prevent deterioration of oil performance. Check the engine oil following the below procedure.

(Diesel) 1.5 VGT

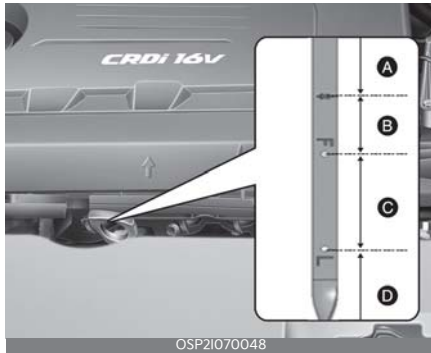

1. Be sure the vehicle is on level ground.
2. Start the engine and allow it to reach normal operating temperature.
3. Turn the engine off, remove the oil filler cap and pull the dipstick out. Wait for 15 minutes for the oil to return to the oil pan.
4. Wipe the dipstick clean and re-insert it fully.
5. Pull the dipstick out again and check the level. The level should be in the C range. If the level is in the D range, add enough engine oil to bring the level up the range.

### ⚠ WARNING

#### Radiator hose

Be very careful not to touch the radiator hose when checking or adding the engine oil as it may be hot enough to burn you.

Range	Required action according to the respective engine oil level
A	Contact an authorised Kia dealer/ service partner.
B	Do not refill oil.
C	You may add oil as long as the oil level does not go above C-range.
D	You must add oil and make sure that the oil level is in the C-range.

### ⚠ CAUTION

When you wipe the oil level gauge, you should wipe it with a clean cloth. When mixed with debris, it can cause engine damage.

(Diesel) 1.5 VGT



Use only the specified engine oil. (Refer to "Recommended lubricants and capacities" on page 9-10.)

- Do not spill engine oil when adding or changing engine oil. Wipe off spilled oil immediately.

- The engine oil consumption may increase whilst you break in a new vehicle and it will be stabilized after driving 6,000 km (4,000 miles).
- The engine oil consumption can be affected by driving habits, climate conditions, traffic conditions, oil quality, etc. Therefore, it is recommended that you inspect the engine oil level regularly and refill it if necessary.

### Changing the engine oil and filter

Have the engine oil and filter replaced by a professional workshop. Kia recommends to visit an authorised Kia dealer/service partner.

- If the maintenance schedule to replace engine oil is exceeded, the engine oil performance may deteriorate, and the engine condition may be affected. Therefore, replace the engine oil according to the maintenance schedule.
- To keep the engine in optimal condition, use the recommended engine oil and filter. If the recommended engine oil and filter are not used replace it according to the maintenance schedule under severe usage conditions.
- The purpose of the maintenance schedule for engine oil replacement is to prevent oil deterioration and it is irrelevant to oil consumption. Check and refill engine oil regularly.

#### **⚠ WARNING**

Used engine oil may cause skin irritation or cancer if left in contact with the skin for prolonged periods of time. Used engine oil contains chemicals that have caused cancer in laboratory animals. Always protect your skin by washing your hands thoroughly with soap and warm water as soon as possible after

handling used oil. Do not leave used engine oil within the reach of children.

#### **⚠ CAUTION**

The engine oil is very hot immediately after the vehicle has been driven and can cause burns during replacement. Replace the engine oil after the engine oil has cooled down.

#### **\* NOTICE**

For Smartstream G1.5 T-GDi engine, the enhanced engine protection system which limits engine power will be activated. If the engine oil pressure is restored, the Engine Oil Pressure warning light and the enhanced engine protection system will turn off.

#### **\* NOTICE**

Never add any additives to the engine oil. Engine oil additives can change the properties of engine oil and may cause serious engine failure.

## Engine coolant

The high-pressure cooling system has a reservoir filled with year round anti-freeze coolant. The reservoir is filled at the factory.

Check the antifreeze protection and coolant level at least once a year, at the beginning of the winter season, and before travelling to a colder climate.

### ⚠ WARNING

#### Radiator/Inverter cap

Never attempt to remove the radiator or inverter cap whilst the engine is operating or hot. Doing so might lead to cooling system and engine damage and could result in serious bodily injury from escaping hot coolant or steam.

Ambient Temperature	Mixture Percentage (volume)	
	Antifreeze	Water
-15 °C	35	65
-25 °C	40	60
-35 °C	50	50
-45 °C	60	40

### ⚠ WARNING



#### Radiator cap

Do not remove the radiator cap when the engine and radiator are hot. Scalding hot coolant and steam may blow out under pressure which may result in serious injury.

#### Smartstream G1.5

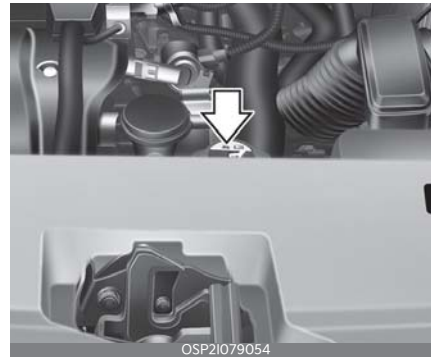

## Recommended coolant

When adding coolant, use only deionized water or soft water for your vehicle and never mix hard water in the coolant filled at the factory. An improper coolant mixture can result in serious malfunction or damage.

- Do not use alcohol or methanol coolant or mix them with the specified coolant.
- Do not use a solution that contains more than 60% antifreeze or less than 35% antifreeze, which would reduce the effectiveness of the solution.
- The cooling circuit of a vehicle equipped with a heat pump system may freeze in extremely low temperature when the concentration of the antifreezing liquid is below 45%.

For mixture percentage, refer to the following table.

Smartstream G1.5 T-GDi



(Diesel) 1.5 VGT

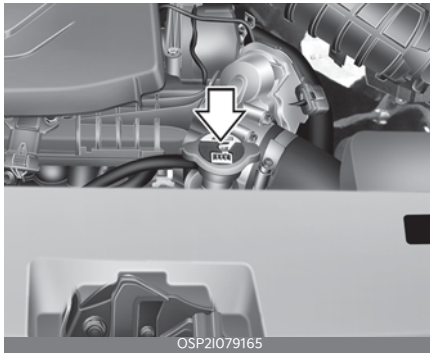

2. Use extreme care when removing the radiator cap. Wrap a thick towel around it, and turn it counterclockwise slowly to the first stop.
3. Step back whilst the pressure is released from the cooling system.
4. When you are sure all the pressure has been released, press down on the cap, using a thick towel, and continue turning counterclockwise to remove it.

**WARNING**



**Cooling fan**

Use caution when working near the blade of the cooling fan. The electric motor (cooling fan) is controlled by coolant temperature, refrigerant pressure and vehicle speed. It may sometimes operate even when the vehicle is not running.

**Checking the coolant level**

**WARNING**



**Removing radiator cap**

Never attempt to remove the radiator cap whilst the engine is operating or hot. Doing so might lead to cooling system damage and could result in serious personal injury from escaping hot coolant or steam.

1. Turn the vehicle off and wait until it cools down.

5. Check the condition and connections of all cooling system hoses and heater hoses.
6. Replace any swollen or deteriorated hoses.
7. Check the coolant level. The coolant level should be filled between F and L marks on the side of the coolant reservoir when the engine room is cool.

Smartstream G1.5

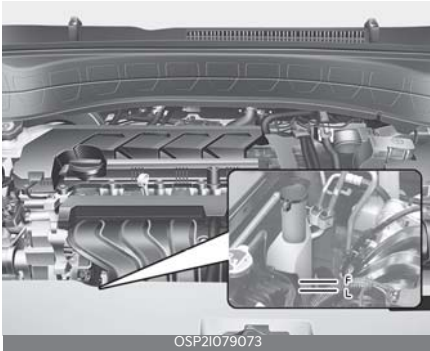

If frequent additions are required, we recommend that the system be inspected by a professional workshop. Kia recommends to visit an authorised Kia dealer/service partner.

Smartstream G1.5 T-GDi



(Diesel) 1.5 VGT



8. If the coolant level is low, add enough specified coolant to provide protection against freezing and corrosion. Bring the level to F, but do not overfill.

## Changing the coolant

We recommend that the coolant be replaced by an authorised Kia dealer according to the Maintenance Schedule at the beginning of this chapter.

### ⚠ CAUTION

Put a thick cloth or fabric around the radiator cap before refilling the coolant in order to prevent the coolant from overflowing into engine parts such as the alternator.

### ⚠ WARNING

#### Coolant

- Do not use radiator coolant or anti-freeze in the washer fluid reservoir.
- Radiator coolant can severely obscure visibility when sprayed on the windscreen and may cause loss of vehicle control or damage to paint and body trim.

## Intelligent Manual Transmission (iMT) system actuator fluid

### Checking the iMT system actuator fluid level



In normal driving conditions, the actuator fluid level does not go down rapidly. However, oil consumption rate may rise as vehicle mileage increases, and leakage in actuator related parts may result in increased consumption of the iMT system actuator oil. Regularly check and make sure the iMT system actuator oil fluid level is between MIN and MAX marks.

If the oil level is below MIN mark, have the vehicle checked by a professional workshop. Kia recommends to visit an authorised Kia dealer/service partner.

If the fluid level is excessively low, have the system checked by a professional workshop. Kia recommends to visit an authorised Kia dealer/service partner.

Use only the specified iMT system actuator fluid. (Refer to "Recommended lubricants and capacities" on page 9-10.) Never mix different types of fluid.

### ⚠ WARNING

#### Loss of iMT system actuator fluid



In the event the iMT system actuator requires frequent additions of fluid, have the system inspected by a professional workshop. Kia recommends to visit an authorised Kia dealer/service partner.

### **⚠ WARNING**

#### **iMT system actuator fluid**

When changing and adding iMT system actuator fluid, handle it carefully.

Do not let it come in contact with your eyes.

If iMT system actuator fluid should come in Contact with your eyes, immediately flush them with a large quantity of fresh tap water.

Have your eyes examined by a doctor as soon as possible.

### **⚠ CAUTION**

Do not allow iMT system actuator fluid to contact the vehicle's body paint, as paint damage will result. The iMT system actuator fluid, which has been exposed to open air for an extended time should never be used as its quality cannot be guaranteed. It should be properly disposed.

Don't put in the wrong kind of fluid. A few drops of mineral based oil, such as engine oil, in your iMT system actuator can damage iMT system actuator parts.

## **Brake/clutch fluid**

The brake/clutch fluid acts to transmit force to the brake when the driver depresses the brake pedal. Brake/clutch fluid must be maintained periodically to ensure that the brakes operate smoothly.

### **Checking the brake/clutch fluid level**

Check the fluid level in the reservoir periodically. The fluid level should be between MAX and MIN marks on the side of the reservoir.

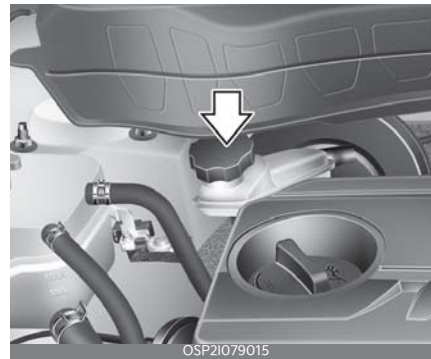

1. Before removing the reservoir cap and adding brake/clutch fluid, clean the area around the reservoir cap thoroughly to prevent brake/clutch fluid contamination.
2. If the level is low, add fluid to the MAX level. The level will fall with accumulated mileage. This is a normal condition associated with the wear of the brake linings. If the fluid level is excessively low, we recommend that the system be checked by a professional workshop. Kia recommends to visit an authorised Kia dealer/service partner.

Use only the specified brake/clutch fluid. (Refer to "Recommended lubricants and capacities" on page 9-10.)

Never mix different types of fluid.

### ⚠ WARNING

In the event the brake system requires frequent additions of fluid, we recommend that the system be checked by a professional workshop. Kia recommends to visit an authorised Kia dealer/service partner.

### ⚠ WARNING

When changing and adding brake/clutch fluid, handle it carefully. Do not let it come in contact with your eyes. If brake/clutch fluid should come in contact with your eyes, immediately flush them with a large quantity of fresh tap water. Have your eyes examined by a doctor as soon as possible.

### ⚠ CAUTION

#### Brake/clutch fluid

Do not allow brake/clutch fluid to contact the vehicle's body paint, as paint damage will result.

The brake/clutch fluid constantly absorbs moisture from the air. This lowers the boiling point of the brake/clutch fluid. If the boiling point is too low, vapour pockets may form in the brake system when the brakes are applied hard.

Brake/clutch fluid, which has been exposed to open air for an extended time should never be used as its quality cannot be guaranteed. It should be disposed of properly.

## Washer fluid

Washer fluid is used when wiping the windscreen of the vehicle with a windscreen wiper. You should check and refill washer fluid periodically to make sure that it doesn't run out.

### Checking the washer fluid level



The reservoir is translucent so that you can check the level with a quick visual inspection.

- Check the fluid level in the washer fluid reservoir and add fluid if necessary. Plain water may be used if washer fluid is not available. However, use washer solvent with antifreeze characteristics in cold climates to prevent freezing.

### ⚠ WARNING

#### Coolant

- Do not use radiator coolant or anti-freeze in the washer fluid reservoir.
- Radiator coolant can severely obscure visibility when sprayed on the windscreen and may cause loss of vehicle control or damage to paint and body trim.
- Windscreen Washer fluid agents contain some amounts of alcohol and can be flammable under certain circum-

stances. Do not allow sparks or flame to contact the washer fluid or the washer fluid reservoir. Damage to the vehicle or occupants could occur.

- Windscreen washer fluid is poisonous to humans and animals. Do not drink and avoid contacting windscreen washer fluid. Serious injury or death could occur.
- 

## Parking brake

### Checking the parking brake

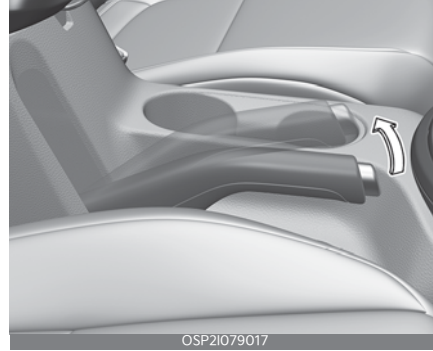

Check the stroke of the parking brake by counting the number of "clicks" heard whilst fully applying it from the released position. Also, the parking brake alone should securely hold the vehicle on a fairly steep grade. If the stroke is more or less than specified, have the system serviced by a professional workshop. Kia recommends to visit an authorised Kia dealer/service partner.

**Stroke: 6~8 "clicks" at a force of 20 kg (44 lbs, 196 N).**

## Fuel Filter (for diesel)

### Draining water from the fuel filter

The fuel filter for diesel engine plays an important role of separating water from fuel and accumulating the water in its bottom.

If water accumulates in the fuel filter, the warning light comes on when the ignition switch is in the ON position.



If this warning light illuminates, take your car to a professional workshop and have drain the water and check the system. Kia recommends to visit an authorised Kia dealer/service partner.

### **CAUTION**

If the water accumulated in the fuel filter is not drained at proper times, damages to the major parts such as the fuel system can be caused by water permeation in the fuel filter.

## Fuel filter cartridge replacement

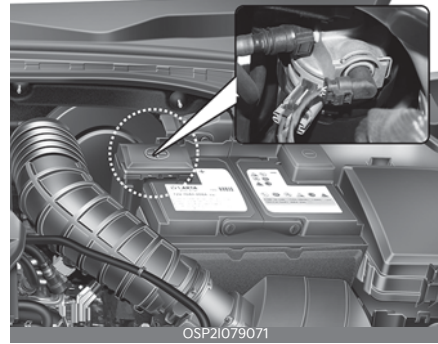

### \* NOTICE

When replacing the fuel filter cartridge, use parts for replacement from a professional workshop. Kia recommends to visit an authorised Kia dealer/service partner.

## Air cleaner filter

A Genuine Kia air cleaner filter is recommended when the filter is replaced.

### Replacing air cleaner filter

Air cleaner filter must be replaced when necessary, and should not be washed.

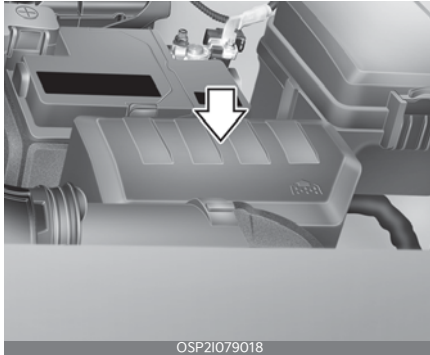

You can clean the filter when inspecting the air cleaner compartment. Clean the filter by using compressed air.

1. Loosen the air cleaner cover (1) attaching clips and open the cover.

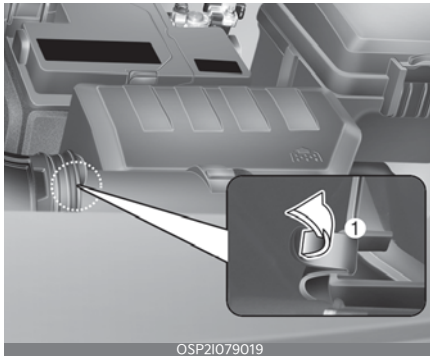

2. Wipe the inside of the air cleaner.
3. Replace the air cleaner filter.

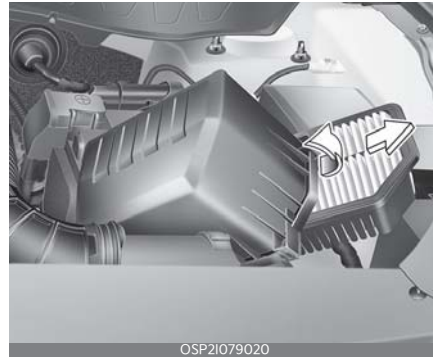

4. Lock the cover with the cover attaching clips.

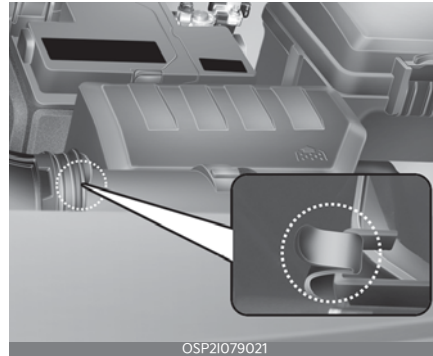

Replace the filter according to the Maintenance Schedule.

If the vehicle is operated in extremely dusty or sandy areas, replace the element more often than the usual recommended intervals. (Refer to "Maintenance Under Severe Usage Conditions" on page 8-14.)

### ⚠ CAUTION

#### Air filter maintenance

- Do not drive with the air cleaner removed; this will result in excessive engine wear.
- When removing the air cleaner filter, be careful that dust or dirt does not

enter the air intake, or damage may result.

- Use parts for replacement from a professional workshop. Kia recommends to visit an authorised Kia dealer/service partner.

Replace the filter according to the Maintenance Schedule.

If the vehicle is operated in extremely dusty or sandy areas, replace the element more often than the usual recommended intervals. (Refer to "Maintenance Under Severe Usage Conditions" on page 8-14.)

### Climate control air filter

The climate control air filter should be replaced according to the maintenance schedule. If the vehicle is operated in severely air-polluted cities or on dusty rough roads for a long period, it should be inspected more frequently and replaced earlier.

### Inspecting and replacing climate control air filter

When you replace the climate control air filter, replace it performing the following procedure. Be careful to avoid damaging other components.

1. Open the glove box.



2. Push both sides of the glove box.

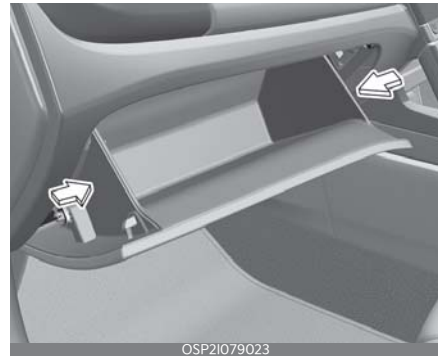

8

- Remove the climate control air filter cover by pulling out right side of the cover.



- Replace the climate control air filter.



- Reassemble in the reverse order of disassembly.

When replacing the climate control air filter install it properly. Otherwise, the system may produce noise and the effectiveness of the filter may be reduced.

## Wiper blades

When the wipers no longer clean adequately, the blades may be worn or cracked, and require replacement.

To prevent damage to the wiper arms or other components, do not attempt to move the wipers manually.

The use of a non-specified wiper blade could result in wiper malfunction and failure.

## Blade inspection

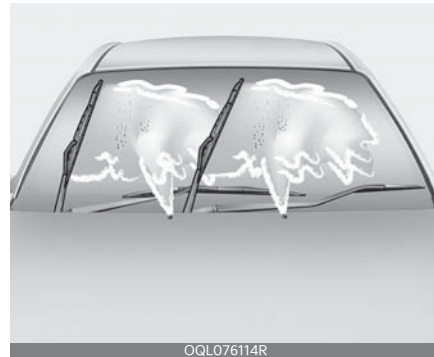

### \* NOTICE

Commercial hot waxes applied by automatic vehicle washes have been known to make the windshield difficult to clean.

Contamination of either the windshield or the wiper blades with foreign matter can reduce the effectiveness of the windshield wipers. Common sources of contamination are insects, tree sap, and hot wax treatments used by some commercial vehicle washes. If the blades are not wiping properly, clean both the window and the blades with a good cleaner or mild detergent, and rinse thoroughly with clean water.

**⚠ CAUTION**

To prevent damage to the wiper blades, do not use petrol, kerosene, paint thinner, or other solvents on or near them.

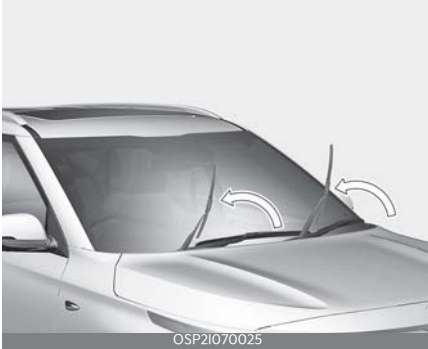
**Front windscreen wiper blade**

To replace wiper blade, lift the arm first and replace the wiper blade as per procedure.

**Replacing front windscreen wiper blade**

1. Raise the wiper arm and turn the wiper blade assembly to expose the plastic locking clip.

**⚠ CAUTION****Wiper arms**

- Do not allow the wiper arm to fall against the windscreen, since it may chip or crack the windscreen.

2. Compress the clip and slide the blade assembly downward.

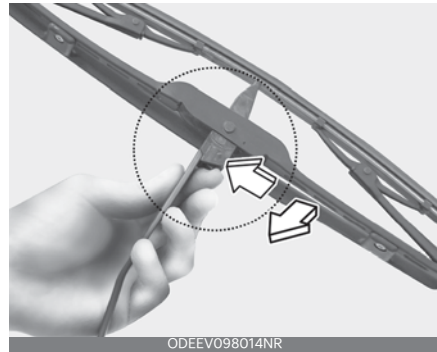

3. Lift it off the arm.

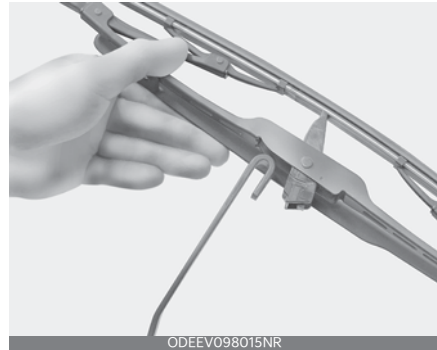

4. Install the blade assembly in the reverse order of removal.

**Replacing rear window wiper blade**

1. Raise the wiper arm and rotate the wiper blade assembly (1).
2. Pull out the wiper blade assembly.



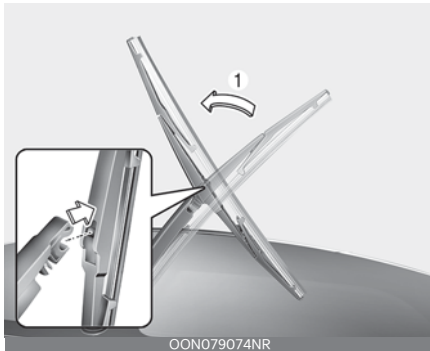

3. Install the new blade assembly by inserting the centre part into the slot in the wiper arm until it clicks into place.
4. Make sure the blade assembly is installed firmly by trying to pull it slightly.

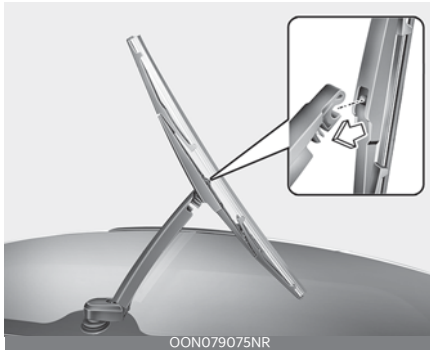

To prevent damage to the wiper arms or other components, have an authorised Kia dealer/service partner replace the wiper blade.

## Battery

The battery powers the engine in order to move the vehicle as well as supplying power to the various devices installed in the vehicle.

### For best battery service

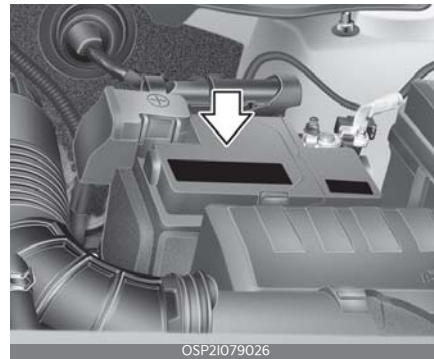

- Keep the battery securely mounted.
- Keep the battery top clean and dry.
- Keep the terminals and connections clean, tight, and coated with petroleum jelly or terminal grease.
- Rinse any spilled electrolyte from the battery immediately with a solution of water and baking soda.
- If the vehicle is not going to be used for an extended time, disconnect the battery cables.

### \* NOTICE

#### For batteries marked with UPPER and LOWER

Basically equipped battery is maintenance free type. If your vehicle is equipped with the battery marked with LOWER and UPPER on the side, you can check the electrolyte level. The electrolyte level should be between LOWER and UPPER. If the electrolyte level is low, it needs to add distilled (demineralized)

water (Never add sulfuric acid or other electrolyte). When refill, be careful not to splash the battery and adjacent components. And do not overfill the battery cells. It can cause corrosion on other parts. After then ensure that tighten the cell caps. Contact a professional workshop. Kia recommends to visit an authorised Kia dealer/service partner.

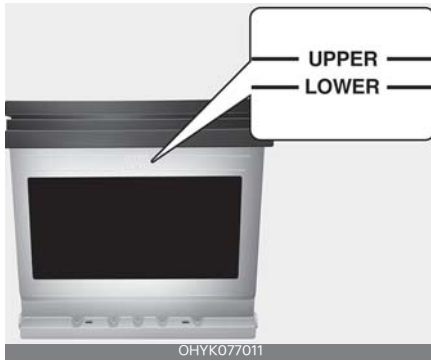

**⚠ WARNING**

**Battery dangers**



Always read the following instructions carefully when handling a battery.



Keep lighted cigarettes and all other flames or sparks away from the battery.



Hydrogen, a highly combustible gas, is always present in battery cells and may explode if ignited.



Keep batteries out of the reach of children because batteries contain highly corrosive SULFURIC ACID. Do not allow battery acid to contact your skin, eyes, clothing or paint finish.



If any electrolyte gets into your eyes, flush your eyes with

clean water for at least 15 minutes and get immediate medical attention. If electrolyte gets on your skin, thoroughly wash the contacted area. If you feel a pain or a burning sensation, get medical attention immediately.



Wear eye protection when charging or working near a battery. Always provide ventilation when working in an enclosed space.



An inappropriately disposed battery can be harmful to the environment and human health. Dispose the battery according to your local law(s) or regulation.



The battery contains lead. Do not dispose of it after use. Please return the battery to an authorised Kia dealer to be

recycled.

- When lifting a plastic-cased battery, excessive pressure on the case may cause battery acid to leak, resulting in personal injury. Lift with a battery carrier or with your hands on opposite corners.
- Never attempt to recharge the battery when the battery cables are connected.
- The electrical ignition system works with high voltage. Never touch these components with the engine running or the ignition switched on.

Failure to follow the above warnings can result in serious bodily injury or death.

**⚠ CAUTION**

If you use unauthorised electronic devices, the battery may be discharged. Never use unauthorised devices.

## Battery capacity label

example



\* The actual battery label in the vehicle may differ from the illustration.

1. 12 V: The nominal voltage
2. 60 Ah: The nominal capacity
3. 550 A: The cold-test current

## Battery recharging

Your vehicle has a maintenance-free, calcium-based battery

- If the battery becomes discharged in a short time (because, for example, the headlights or interior lights were left on whilst the vehicle was not in use), recharge it by slow charging (trickle) for 10 hours.
- If the battery gradually discharges because of high electric load whilst the vehicle is being used, recharge it at 20~30 A for two hours.

### **WARNING**

When recharging the battery, observe the following precautions:

- The battery must be removed from the vehicle and placed in an area with good ventilation.

- Do not allow cigarettes, sparks, or flame near the battery.
- Watch the battery during charging, and stop or reduce the charging rate in following cases:
  1. The battery cells begin gassing (boiling) violently.
  2. The electrolyte temperature of any cell exceeds 49 °C.
- Wear eye protection when checking the battery during charging.
- Disconnect the battery charger in the following order.
  1. Turn off the battery charger main switch.
  2. Unhook the negative clamp from the negative battery terminal.
  3. Unhook the positive clamp from the positive battery terminal.
- Before performing maintenance or recharging the battery, turn off all accessories and stop the vehicle.
- The negative battery cable must be removed first and installed last when the battery is disconnected.

### **CAUTION**

#### **AGM battery (if equipped)**

- Absorbent Glass Mat (AGM) batteries are maintenance free and have the AGM battery serviced by a professional workshop. Kia recommends to visit an authorised Kia dealer/service partner. For charging your AGM battery, use only fully automatic battery chargers that are specially developed for AGM batteries.
- When replacing the AGM battery, use parts for replacement from a professional workshop. Kia recommends to visit an authorised Kia dealer/service partner.

- Do not open or remove the cap on top of the battery. This may cause leaks of internal electrolyte that could result in severe injury.

### Reset items

The following items should be reset after the battery has been discharged or the battery has been disconnected.

- Auto up/down window (Refer to "Window opening and closing" on page 4-23)
- Trip computer (Refer to "Trip information (trip computer)" on page 4-57)
- Climate control system (Refer to "Automatic climate control system (if equipped)" on page 4-101)

## Tyres and wheels

For proper maintenance, safety, and maximum fuel economy, you must always maintain the recommended tyre inflation pressures and stay within the load limits and weight distribution recommended for your vehicle.

### Recommended cold tyre inflation pressures

All tyre pressures should be checked when the tyres are cold. "Cold Tyres" means the vehicle has not been driven for at least three hours or driven less than 1.6 km.

Recommended pressures must be maintained for the best ride, vehicle handling, and minimum tyre wear.

For recommended inflation pressure, refer to "Tyres and wheels" on page 9-9.

All specifications (sizes and pressures) can be found on a label attached to the driver's side centre pillar.

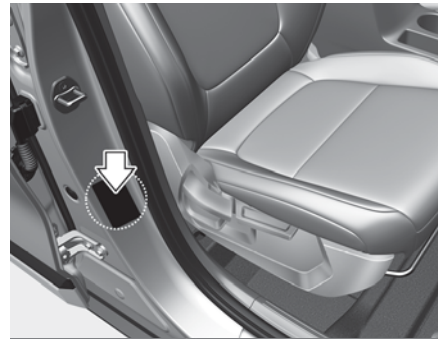

8

### ⚠ WARNING

#### Tyre underinflation

Inflate your tyres consistent with the instructions provided in this manual. Regularly check the tyre inflation pressure, and correct it as needed: at least twice a month and before any long trips

on the road. If you fail to observe this precaution, you may be driving on underinflated tyres, which may not only compromise your vehicle's driving stability, but also lead to tyre damage and the risk of an accident. This risk is much higher on hot days and when driving for long periods at high speeds.

Failure to maintain specified pressure may result in excessive wear, poor handling, reduced fuel economy, deformation of tyre and/or wheel, harsh ride conditions, possibility for additional damage from road hazards, or result in tyre failure.

### Tyre pressure

Always observe the following:

- Check tyre pressure when the tyres are cold. (After vehicle has been parked for at least three hours or hasn't been driven more than 1.6 km since startup.)
- Check the pressure of your spare tyre each time you check the pressure of other tyres.
- Never overload your vehicle. Be careful not to overload a vehicle luggage rack if your vehicle is equipped with one.
- Warm tyres normally exceed recommended cold tyre pressures by 28~41 kPa. Do not release air from warm tyres to adjust the pressure or the tyres will be underinflated.

#### WARNING

#### Tyre Inflation

Overinflation or underinflation can reduce tyre life, adversely affect vehicle handling, and lead to sudden tyre fail-

ure. This could result in loss of vehicle control and potential injury.

### Checking tyre inflation pressure

Check your tyres once a month or more. Use a good quality gauge to check tyre pressure. You cannot tell if your tyres are properly inflated simply by looking at them. Radial tyres may look properly inflated even when they're underinflated.

Check the tyre's inflation pressure when the tyres are cold. "Cold" means your vehicle has been sitting or at least three hours or driven no more than 1.6 km.

1. Remove the valve cap from the tyre valve stem.
2. Press the tyre gauge firmly onto the valve to get a pressure measurement. If the cold tyre inflation pressure matches the recommended pressure on the tyre and loading information label, no further adjustment is necessary.
3. If the pressure is low, add air until you reach the recommended amount.
4. If you overfill the tyre, release air by pushing on the metal stem in the centre of the tyre valve.
5. Recheck the tyre pressure with the tyre gauge.
6. Be sure to put the valve caps back on the valve stems. They help prevent leaks by keeping out dirt and moisture.

Inspect your tyres frequently for proper inflation as well as wear and damage. Always use a tyre pressure gauge.

Tyres with too much or too little pressure wear unevenly. This could result in poor handling, loss of vehicle control, and sudden tyre failure leading to accidents,

injuries, and even death. The recommended cold tyre pressure for your vehicle can be found in this manual and on the tyre label located on the driver's side centre pillar.

### Tyre rotation

To equalize tread wear, it is recommended that the tyres be rotated every 10,000 km (6,500 miles) or sooner if irregular wear develops.

During rotation, check the tyres for correct balance.

When rotating tyres, check for uneven wear and damage. Abnormal wear is usually caused by incorrect tyre pressure, improper wheel alignment, out of balance wheels, severe braking or severe cornering. Look for bumps or bulges in the tread or side of tyre.

Replace the tyre if you find either of these conditions. Replace the tyre if fabric or cord is visible. After rotation, be sure to bring the front and rear tyre pressures to specification and check lug nut tightness. (proper torque is 11~13 kgf·m)

Refer to "Tyres and wheels" on page 9-9.

Disc brake pads should be inspected for wear whenever tyres are rotated.

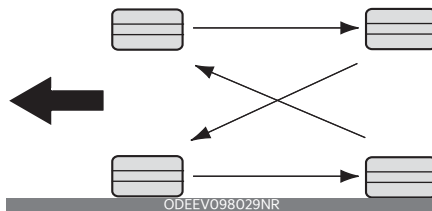

Rotate radial tyres that have an asymmetric tread pattern only from front to rear and not from right to left.

### ⚠ WARNING

#### Mixing tyres

Do not mix bias ply and radial ply tyres under any circumstances. This may cause unusual handling characteristics.

#### Wheel alignment and tyre balance

The wheels on your vehicle were aligned and balanced carefully at the factory to give you the longest tyre life and best overall performance.

In most cases, you will not need to have your wheels aligned again. However, if you notice unusual tyre wear or your vehicle pulling one way or the other, the alignment may need to be reset.

If you notice your vehicle vibrating when driving on a smooth road, your wheels may need to be rebalanced.

### ⚠ CAUTION

#### Wheel weight

Improper wheel weights can damage your vehicle's aluminum wheels. Use only approved wheel weights.

#### Tyre replacement

If the tyre is worn evenly, a tread wear indicator will appear as a solid band across the tread.



This shows there is less than 1.6 mm of tread left on the tyre. Replace the tyre when this happens.

Do not wait for the band to appear across the entire tread before replacing the tyre.

The Anti-lock Brake System (ABS) works by comparing the speed of the wheels. The tyre size affects wheel speed. When replacing tyres, all 4 tyres must use the same size originally supplied with the vehicle. Using tyres of a different size can cause the ABS and Electronic Stability Control (ESC) to work irregularly.

It is best to replace all four tyres at the same time. If that is not possible, or necessary, then replace the two front or two rear tyres as a pair. Replacing just one tyre can seriously affect your vehicle's handling.

#### \* NOTICE

We recommend that when replacing tyres, use the same originally supplied with the vehicles. If not, that affects driving performance.

### Compact spare tyre replacement (if equipped)

A compact spare tyre has a shorter tread life than a regular size tyre.

Replace it when you can see the tread wear indicator bars on the tyre. The replacement compact spare tyre should be the same size and design tyre as the one provided with your new vehicle and should be mounted on the same compact spare tyre wheel. The compact spare tyre is not designed to be mounted on a regular size wheel, and the compact spare tyre wheel is not designed for mounting a regular size tyre.

### Wheel replacement

When replacing the metal wheels for any reason, make sure the new wheels are equivalent to the original factory units in diameter, rim width and offset.

A wheel with an incorrect size may adversely affect many things: wheel and bearing life, braking and stopping abilities, handling characteristics, ground clearance, body-to-tyre clearance, snow chain clearance, speedometer and odometer calibration, headlight aiming and bumper height.

#### ⚠ CAUTION

##### Wheels

Wheels that do not meet Kia specifications may fit poorly and result in damage to the vehicle or unusual handling and poor vehicle control.

### Tyre traction

Tyre traction can be reduced if you drive on worn tyres, tyres that are improperly inflated or on slippery road surfaces.

## Tyre maintenance

In addition to proper inflation, correct wheel alignment helps to decrease tyre wear.

If you find a tyre is worn unevenly, have your dealer check the wheel alignment.

When you have new tyres installed, make sure they are balanced. This will increase vehicle ride comfort and tyre life. Additionally, a tyre should always be rebalanced if it is removed from the wheel.

## Tyre sidewall labeling

This information identifies and describes the fundamental characteristics of the tyre and also provides the Tyre Identification Number (TIN) for safety standard certification.

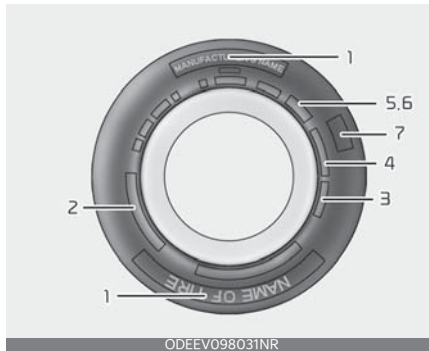

The TIN can be used to identify the tyre in case of a recall.

### 1. Manufacturer or brand name

Manufacturer or Brand name is shown.

### 2. Tyre size designation

A tyre's sidewall is marked with a tyre size designation. You will need this information when selecting replacement tyres for your vehicle. The following

explains what the letters and numbers in the tyre size designation mean.

Example tyre size designation:

(These numbers are provided as an example only; your tyre size designator could vary depending on your vehicle.)

### 225/45R17 91V

- 225: Tyre width in millimeters.
- 45: Aspect ratio. The tyre's section height as a percentage of its width.
- R: Tyre construction code (Radial).
- 17: Rim diameter in inches.
- 91: Load Index, a numerical code associated with the maximum load the tyre can carry.
- V: Speed Rating Symbol. See the speed rating chart in this section for additional information.

## Wheel size designation

Wheels are also marked with important information that you need if you ever have to replace one. The following explains what the letters and numbers in the wheel size designation mean.

Example wheel size designation:

### 7.0JX17

- 7.0: Rim width in inches.
- J: Rim contour designation.
- 17: Rim diameter in inches.

## Tyre speed ratings

The chart below lists many of the different speed ratings currently being used for passenger vehicle tyres. The speed rating is part of the tyre size designation on the sidewall of the tyre. This symbol corresponds to that tyre's designed maximum safe operating speed.



Speed Rating Symbol	Maximum Speed
S	180 km/h
T	190 km/h
H	210 km/h
V	240 km/h
W	270 km/h
Y	300 km/h

### 3. Checking tyre life

Any tyres that are over 6 years old, based on the manufacturing date, should be replaced by new ones. You can find the manufacturing date on the tyre sidewall (possibly on the inside of the wheel), displaying the DOT code. The DOT code is a series of numbers on a tyre consisting of numbers and English letters. The manufacturing date is designated by the last four digits (characters) of the DOT code.

#### DOT: XXXX XXXX 0000

The front part of the DOT means a plant code number, tyre size and tread pattern and the last four numbers indicate week and year manufactured.

For example:

DOT XXXX XXXX 1623 represents that the tyre was produced in the 16th week of 2023.

#### WARNING

#### Tyre age

Replace tyres within the recommended time frame. Failure to replace tyres as recommended can result in sudden tyre failure, which could lead to a loss of control and an accident.

### 4. Tyre ply composition and material

The number of layers or plies of rubber-coated fabric in the tyre. Tyre manufacturers also must indicate the materials in the tyre, which include steel, nylon, polyester, and others. The letter "R" means radial ply construction; the letter "D" means diagonal or bias ply construction; and the letter "B" means belted-bias ply construction.

### 5. Maximum permissible inflation pressure

This number is the greatest amount of air pressure that should be put in the tyre. Do not exceed the maximum permissible inflation pressure.

Refer to "Tyres and wheels" on page 9-9 for recommended inflation pressure.

### 6. Maximum load rating

This number indicates the maximum load in kilograms and pounds that can be carried by the tyre. When replacing the tyres on the vehicle, always use a tyre that has the same load rating as the factory installed tyre.

### 7. Uniform tyre quality grading

Quality grades can be found where applicable on the tyre sidewall between tread shoulder and maximum section width.

For example:

- TREADWEAR 200
- TRACTION AA
- TEMPERATURE A

Tyres degrade over time, even when they are not being used. Regardless of the remaining tread, we recommend

that tyres be replaced after approximately six (6) years of normal service. Heat caused by hot climate or frequent high loading conditions can accelerate the aging process.

### Tread wear

The tread wear grade is a comparative rating based on the wear rate of the tyre when tested under controlled conditions on a specified government test course. For example, a tyre graded 150 would wear one-and-a-half times (1½) as well on the government course as a tyre graded 100.

The relative performance of tyres depends upon the actual conditions of their use. Performance may depart significantly from the norm due to variations in driving habits, service practices and differences in road characteristics and climate.

These grades are molded on the sidewalls of passenger vehicle tyres. The tyres available as standard or optional equipment on your vehicle may vary with respect to grade.

### Traction - AA, A, B & C

The traction grades, from highest to lowest, are AA, A, B and C. Those grades represent the tyre's ability to stop on wet pavement as measured under controlled conditions on specified government test surfaces of asphalt and concrete. A tyre marked C may have poor traction performance.

The traction grade assigned to this tyre is based on straight-ahead braking traction tests, and does not include acceleration, cornering, hydroplaning, or peak traction characteristics.

### Temperature -A, B & C

The temperature grades are A (the highest), B, and C, representing the tyre's resistance to the generation of heat and its ability to dissipate heat when tested under controlled conditions on a specified indoor laboratory test wheel.

Sustained high temperature can cause the material of the tyre to degenerate and reduce tyre life, and excessive temperature can lead to sudden tyre failure. Grades B and A represent higher levels of performance on the laboratory test wheel than the minimum required by law.

#### ▲ WARNING

The traction grade assigned to this tyre is based on straight-ahead braking traction tests, and does not include acceleration, cornering, hydroplaning, or peak traction characteristics.

#### ▲ WARNING

### Tyre temperature

The temperature grade for this tyre is established for a tyre that is properly inflated and not overloaded. Excessive speed, Under inflation, or excessive loading, either separately or in combination, can cause heat build-up and possible sudden tyre failure. This can cause loss of vehicle control and serious injury or death.

### Tyre terminology and definitions

Refer to the following for detailed definitions of the terms that are found in the tyre description.

**Air Pressure** The amount of air inside the tyre pressing outward on the tyre.

Air pressure is expressed in pounds per square inch (psi) or kilopascal (kPa).

**Accessory Weight** The combined weight of optional accessories. Some examples of optional accessories are automatic transmission, power seats, and air conditioning.

**Aspect Ratio** The relationship of a tyre's height to its width.

**Belt** A rubber coated layer of cords that is located between the plies and the tread. Cords may be made from steel or other reinforcing materials.

**Bead** The tyre bead contains steel wires wrapped by steel cords that hold the tyre onto the rim.

**Bias Ply Tyre** A pneumatic tyre in which the plies are laid at alternate angles less than 90 degrees to the centerline of the tread.

**Cold Tyre Pressure** The amount of air pressure in a tyre, measured in pounds per square inch (psi) or kilopascals (kPa) before a tyre has built up heat from driving.

**Kerb Weight** The weight of a motor vehicle with standard and optional equipment (including the maximum capacity of fuel, oil and coolant), but without passengers and cargo.

**DOT Markings** The DOT code includes the Tyre Identification Number (TIN), an alphanumeric designator which can also identify the tyre manufacturer, production plant, brand and date of production.

**GVWR** Gross Vehicle Weight Rating

**GAWR FRT** Gross Axle Weight Rating for the Front axle.

**GAWR RR** Gross Axle Weight Rating for the Rear axle.

**Intended Outboard Sidewall** The side of an asymmetrical tyre that must

always face outward when mounted on a vehicle.

**Kilopascal (kPa)** The metric unit for air pressure.

**Light truck (LT) tyre** A tyre designated by its manufacturer as primarily intended for use on lightweight trucks or multipurpose passenger vehicles.

**Load ratings** The maximum load that a tyre is rated to carry for a given inflation pressure.

**Load Index** An assigned number ranging from 1 to 279 that corresponds to the load carrying capacity of a tyre.

**Maximum Inflation Pressure** The maximum air pressure to which a cold tyre may be inflated. The maximum air pressure is molded onto the sidewall.

**Maximum Load Rating** The load rating for a tyre at the maximum permissible inflation pressure for that tyre.

**Maximum Loaded Vehicle Weight** The sum of kerb weight; accessory weight; vehicle capacity weight; and production options weight.

**Normal Occupant Weight** The number of occupants a vehicle is designed to seat multiplied by 68 kg (150 lbs.).

**Occupant Distribution** Designated seating positions.

**Outward Facing Sidewall** The side of a asymmetrical tyre that has a particular side that faces outward when mounted on a vehicle. The outward facing sidewall bears white lettering or bears manufacturer, brand, and/or model name molding that is higher or deeper than the same moldings on the inner facing sidewall.

**Passenger (P-Metric) Tyre** A tyre used on passenger cars and some light duty trucks and multipurpose vehicles.

**Ply** A layer of rubber-coated parallel cords.

**Pneumatic tyre** A mechanical device made of rubber, chemicals, fabric and steel or other materials, that, when mounted on an automotive wheel, provides the traction and contains the gas or fluid that sustains the load.

**Production options weight** The combined weight of installed regular production options weighing over 2.3 kg (5 lb.) in excess of the standard items which they replace, not previously considered in kerb weight or accessory weight. Examples include heavy duty brakes, ride levelers, roof rack, heavy duty battery, and special trim.

**Recommended Inflation Pressure** Vehicle manufacturer's recommended tyre inflation pressure and shown on the tyre placard.

**Radial Ply Tyre** A pneumatic tyre in which the ply cords that extend to the beads are laid at 90 degrees to the centerline of the tread.

**Rim** A metal support for a tyre and upon which the tyre beads are seated.

**Sidewall** The portion of a tyre between the tread and the bead.

**Speed Rating** An alphanumeric code assigned to a tyre indicating the maximum speed at which a tyre can operate.

**Traction** The friction between the tyre and the road surface. The amount of grip provided.

**Tread** The portion of a tyre that comes into contact with the road.

**Treadwear Indicators** Narrow bands, sometimes called "wear bars," that show across the tread of a tyre when only 1.6 mm (2/32 inch) of tread remains.

**UTQGS** Uniform Tyre Quality Grading Standards, a tyre information system

that provides consumers with ratings for a tyre's traction, temperature and treadwear. Ratings are determined by tyre manufacturers using government testing procedures. The ratings are molded into the sidewall of the tyre.

**Vehicle Capacity Weight** The weight of designated seating positions multiplied by 68 kg (150 lbs.) plus the rated cargo and luggage load.

**Vehicle Maximum Load on the Tyre** Load on an individual tyre due to kerb and accessory weight plus maximum occupant and cargo weight.

**Vehicle Normal Load on the Tyre** Load on an individual tyre that is determined by distributing to each axle its share of the kerb weight, accessory weight, and normal occupant weight and driving by 2.

**Vehicle Placard** A label permanently attached to a vehicle showing the original equipment tyre size and recommended inflation pressure.

### All season tyres

Kia specifies all season tyres on some models to provide good performance for use all year round, including snowy and icy road conditions.

All season tyres are identified by ALL SEASON and/or M+S (Mud and Snow) on the tyre sidewall. Snow tyres have better snow traction than all season tyres and may be more appropriate in some areas.

### Summer tyres

Kia specifies summer tyres on some models to provide superior performance on dry roads.

Summer tyre performance is substantially reduced in snow and ice. Summer tyres do not have the tyre traction rating

M+S (Mud and Snow) on the tyre side wall. If you plan to operate your vehicle in snowy or icy conditions, Kia recommends the use of snow tyres or all-season tyres on all four wheels.

### Snow tyres

If you equip your vehicle with snow tyres, they should be the same size and have the same load capacity as the original tyres.

Snow tyres should be installed on all four wheels; otherwise, poor handling may result.

Snow tyres should carry 4 psi (28 kPa) more air pressure than the pressure recommended for the standard tyres on the tyre label on the driver's side of the centre pillar, or up to the maximum pressure shown on the tyre sidewall, whichever is less.

Do not drive faster than 120 km/h (75 mph) when your vehicle is equipped with snow tyres.

### WARNING

Do not use summer tyres at temperatures below 7 °C (45 °F) or when driving on snow or ice. At temperatures below 7 °C (45 °F), summer tyres can lose elasticity, and therefore traction and braking power as well. Change the tyres on your vehicle to winter or all-weather tyres of the same size as the standard tyres of the vehicle. Both types of tyres are identified by the M+S (Mud and Snow) marking. Using summer tyres at very cold temperatures could cause cracks to form, thereby damaging the tyres permanently.

### Tyre chains

Tyre chains, if necessary, should be installed on the front wheels.

Be sure that the chains are installed in accordance with the manufacturer's instructions.

To minimise tyre and chain wear, do not continue to use tyre chains when they are no longer needed.

- When driving on roads covered with snow or ice, drive at less than 30 km/h (20 mph).
- Use the SAE "S" class or wire chains.
- If you hear noise caused by chains contacting the body, retighten the chain to avoid contact with the vehicle body.
- To prevent body damage, retighten the chains after driving 0.5~1.0 km (0.3~0.6 miles).
- Do not use tyre chains on vehicles equipped with aluminum wheels. In unavoidable circumstance, use a wire type chain.
- Use wire chains less than 12 mm (0.47 inches) to prevent damage to the chain's connection.
- Fabric-type chains must be used on the vehicle with 17 inch (215/60R17) and 18 inch (215/55R18) tyres.

### Radial-ply tyres

Radial-ply tyres provide improved tread life, road hazard resistance and smoother high speed ride.

The radial-ply tyres used on this vehicle are of belted construction, and are selected to complement the ride and handling characteristics of your vehicle. Radial-ply tyres have the same load carrying capacity, as bias-ply or bias belted tyres of the same size, and use the same recommended inflation pressure.

Mixing of radial-ply tyres with bias-ply or bias belted tyres is not recommended. Any combinations of radial-ply and bias-

ply or bias belted tyres when used on the same vehicle will seriously deteriorate vehicle handling. The best rule to follow is: Identical radial-ply tyres should always be used as a set of four.

Longer wearing tyres can be more susceptible to irregular tread wear. It is very important to follow the tyre rotation interval shown in this section to achieve the tread life potential of these tyres. Cuts and punctures in radial-ply tyres are repairable only in the tread area, because of sidewall flexing. Consult your tyre dealer for radial-ply tyre repairs.

### Low aspect ratio tyre (if equipped)

Low aspect ratio tyres, whose aspect ratio is lower than 50, are provided for sporty looks.

Because the low aspect ratio tyres are optimized for handling and braking, it may be more uncomfortable to ride in and there is more noise compare with normal tyres.

#### **⚠ CAUTION**

Because the sidewall of the low aspect ratio tyre is shorter than the normal, the wheel and tyre of the low aspect ratio tyre is easier to be damaged. So, follow the instructions below.

- When driving on a rough road or off road, drive cautiously because tyres and wheels may be damaged. And after driving, inspect tyres and wheels.
- When passing over a pothole, speed bump, manhole, or kerb stone, drive slowly so that the tyres and wheels are not damaged.
- If the tyre is impacted, inspect the tyre condition or contact a professional

workshop. Kia recommends to visit an authorised Kia dealer/service partner.

- To prevent damage to the tyre, inspect the tyre condition and pressure every 3,000 km.

#### **⚠ CAUTION**

- It is not easy to recognize the tyre damage with your own eyes. But if there is the slightest hint of tyre damage, even though you cannot see the tyre damage with your own eyes, have the tyre checked or replaced because the tyre damage may cause air leakage from the tyre.
- If the tyre is damaged by driving on a rough road, off road, pothole, manhole, or kerb stone, it will not be covered by the warranty.
- You can find out the tyre information on the tyre sidewall.

## Fuses

A vehicle's electrical system is protected from electrical overload damage by fuses.

Blade type



Cartridge type



Multi fuse

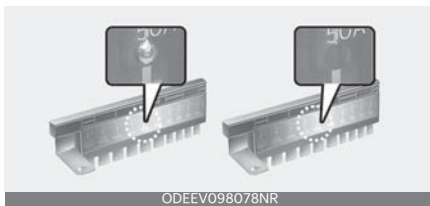

BFT



\* Left side: Normal, Right side: Blown  
This vehicle has 2 (or 3) fuse panels, one located in the driver's side panel bolster, the other in the engine compartment near the battery.

If any of your vehicle's lights, accessories, or controls do not work, check the appropriate circuit fuse. If a fuse has blown, the element inside the fuse will melt.

If the electrical system does not work, first check the driver's side fuse panel. If the replacement fuse blows, this indicates an electrical problem. Avoid using the system involved and immediately consult a professional workshop. Kia recommends to visit an authorised Kia dealer/service partner.

Three kinds of fuses are used: blade type for lower amperage rating, cartridge type, and multi fuse for higher amperage ratings.

### ⚠ WARNING

#### Fuse replacement

- Never replace a fuse with anything but another fuse of the same rating.
- A higher capacity fuse could cause damage and possibly a fire.
- Never install a wire or aluminum foil instead of the proper fuse - even as a temporary repair. It may cause extensive wiring damage and a possible fire.
- Do not arbitrarily modify or add-on electric wiring to the vehicle.

### ⚠ CAUTION

Do not use a screwdriver or any other metal object to remove fuses because it may cause a short circuit and damage the system.

### \* NOTICE

- When replacing a fuse, turn the ignition 'OFF' and turn off switches of all

electrical devices then remove battery (-) terminal.

- The actual fuse/relay panel label may differ from equipped items.

### **⚠ WARNING**

#### **Electrical Fire**

Always ensure replacements fuses and relays are securely fastened when installed. Failure to do so can result in a vehicle fire.

Do not remove fuses, relays and terminals fastened with bolts or nuts. The fuses, relays and terminals may be fastened incompletely, and it may cause a possible fire. If fuses, relays and terminals fastened with bolts or nuts are blown, we recommend that you consult a professional workshop. Kia recommends to visit an authorised Kia dealer/service partner.

### **⚠ CAUTION**

When replacing a blown fuse or relay, make sure the new fuse or relay fits tightly into the clips. Failure to tightly install the fuse or relay may cause damage to the wiring and electric systems.

### **⚠ CAUTION**

- Do not input any other objects except fuses or relays into fuse/relay terminals such as a screwdriver or wiring. It may cause contact failure and system malfunction.
- Do not plug in screwdrivers or after-market wiring into the terminal originally designed for fuse and relays only. The electrical system and wiring of the vehicle interior may be damaged or burned due to contact failure.

- If you directly connect the wire on the taillight or replace the bulb which is over the regulated capacity to install trailers etc., the inner junction block can get burned.

### **⚠ WARNING**

#### **Electrical wiring repairs**

All electrical repairs should be performed by authorised Kia dealerships using approved Kia parts. Using other wiring components, especially when retrofitting multimedia or theft alarm system, car phone or radio may cause vehicle damage and increase the risk of a vehicle fire.

### **\* NOTICE**

#### **Remodeling Prohibited**

Do not rewire your vehicle in any way as doing so may affect the performance of several safety features in your vehicle. Rewiring your vehicle may also void your warranty and cause you to be responsible for any subsequent vehicle damage which may result.



### Replacing inner panel fuse

1. Turn the ignition switch and all other switches off.
2. Open the fuse panel cover.



3. Pull the suspected fuse straight out. Use the removal tool provided on the engine fuse panel cover.

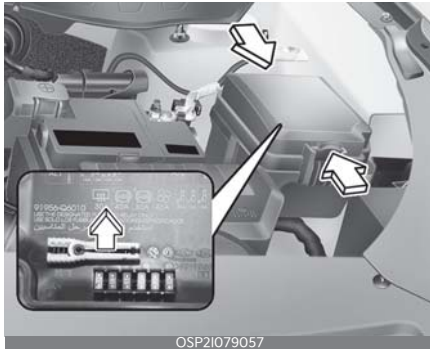

4. Check the removed fuse; replace it if it is blown. Spare fuses are provided in the engine compartment fuse panel.
5. Push in a new fuse of the same rating, and make sure it fits tightly in the clips.

If it fits loosely, we recommend that you consult a professional workshop. Kia recommends to visit an authorised Kia dealer/service partner.

If you do not have a spare, use a fuse of the same rating from a circuit you may not need for operating the vehicle, such as the power outlet fuse.

If the head lamp, turn signal lamp, stop signal lamp, fog lamp, DRL, tail lamp, High Mounted Stop Lamp (HMSL) do not work and the fuses are OK, check the fuse panel in the engine compartment. If a fuse is blown, it must be replaced.

### Replacing engine compartment fuse

1. Turn the ignition switch and all other switches off.
2. Remove the fuse panel cover by pressing the tab and pulling the cover up.

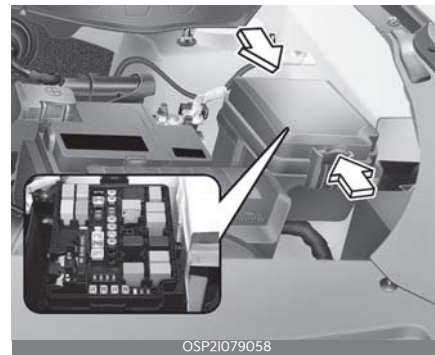

3. Check the removed fuse; replace it if it is blown. To remove or insert the fuse, use the fuse puller in the engine compartment fuse panel.
4. Push in a new fuse of the same rating, and make sure it fits tightly in the clips. If it fits loosely, we recommend that you consult a professional workshop. Kia recommends to visit an authorised Kia dealer/service partner.

#### **CAUTION**

After checking the fuse panel in the engine compartment, securely install the

fuse panel cover through the audible clicking sound.

If not, electrical failures may occur from water contact.

### Main fuse (Multi fuse)

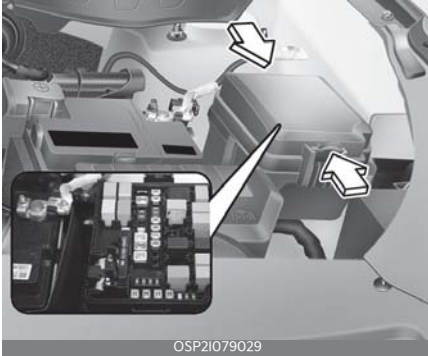

If the multi fuse is blown, it must be removed as follows:

1. Turn the ignition switch and all other switches off.
2. Disconnect the negative battery cable.
3. Remove the nuts shown in the picture above.
4. Replace the fuse with a new one of the same rating.
5. Reverse these steps to reinstall the multi fuse.

#### \* NOTICE

If the multi fuse is blown, consult a professional workshop. Kia recommends to consult an authorised Kia dealer/service partner.

### Driver's side fuse panel







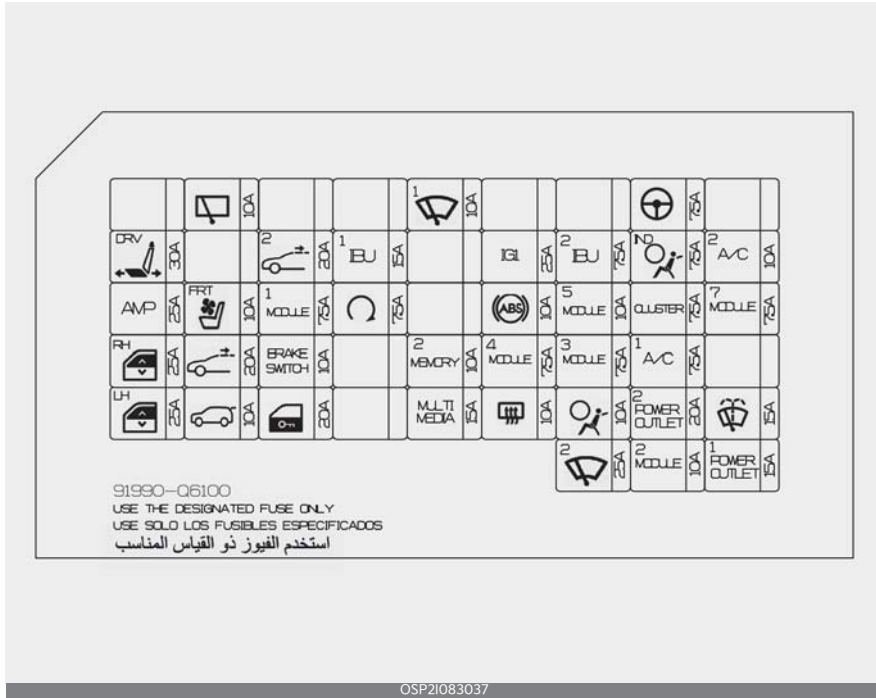









#### \* NOTICE



Not all fuse panel descriptions in this manual may be applicable to your vehicle. It is accurate at the time of printing. When you inspect the fuse panel in your vehicle, refer to the fuse panel label on the inside of the fuse cover. This diagram will provide you with the specific information for your vehicles.



Refer to the following table for a description of the fuse.

Fuse Name	Symbol	Fuse rating	Circuit Protected
P/SEAT (DRV)		30 A	Driver Seat Manual Switch
AMP	<b>AMP</b>	25 A	Without ISG: AMP (Amplifier) With ISG: DC-DC Converter Unit
P/WDW RH		25 A	Power Window Relay RH, Driver Safety Power Window Module
P/WDW LH		25 A	Power Window Relay LH, Driver Safety Power Window Module
WIPER RR		10 A	Engine Room Block (Rear Wiper Relay), Rear Wiper Motor
SEAT VENT FRT		10 A	Front Air Ventilation Seat Control Module
SUNROOF		20 A	Sunroof Unit
TAIL GATE OPEN		10 A	Tail Gate Relay
MODULE 1	<b><sup>1</sup>MODULE</b>	7.5 A	Hazard Switch, Data Link Connector

Fuse Name	Symbol	Fuse rating	Circuit Protected
BRAKE SWITCH	<b>BRAKE SWITCH</b>	10 A	Stop Lamp Switch, IBU (Integrated Body Control Unit)
DOOR LOCK		20 A	Door Lock Relay, Door Unlock Relay
IBU1	<sup>1</sup> <b>IBU</b>	15 A	IBU (Integrated Body Control Unit)
START		7.5 A	[Manual Transmission & Without Smart Key] Ignition Lock & Clutch Switch [Manual Transmission & With Smart Key] Engine Room Block (Start Relay), IBU (Integrated Body Control Unit), ECM (Engine Control Module), PCM (Power train Control Module) [Auto Transmission] Transmission Range Switch
WIPER FRT1	<sup>1</sup> 	10 A	IBU (Integrated Body Control Unit), ECM (Engine Control Module)/PCM (Power train Control Module)
MEMORY 2	<sup>2</sup> <b>MEMORY</b>	10 A	ICM (Integrated Circuit Module) Relay Box (Outside Mirror Folding/Unfolding Relay), Instrument Cluster, Air Conditioner Control Module, Security Indicator, Head-Up Display
MULTI MEDIA	<b>MULTI MEDIA</b>	15 A	Audio, Audio/Video & Navigation Head Unit
IG1	<b>IG1</b>	25 A	Engine Room Block (Fuse - F33, F34, F35)
ABS	<b>ABS</b>	10 A	ESP (Electronic Stability Program) Control Module
REAR HAETED		10 A	ECM (Engine Control Module), PCM (Power train Control Module), Air Conditioner Control Module
IBU2	<sup>2</sup> <b>IBU</b>	7.5 A	IBU (Integrated Body Control Unit)
MODULE 5	<sup>5</sup> <b>MODULE</b>	10 A	Electro Chromic Mirror, IBU (Integrated Body Control Unit), Front Wireless Charger, Auto Transmission Shift Lever Indicator, Driver Console Switch, Audio, Audio/Video & Navigation Head Unit, Air Conditioner Control Module, Crash Pad Switch, AMP (Amplifier), Front Air Ventilation Seat Control Module
MODULE 3	<sup>3</sup> <b>MODULE</b>	7.5 A	Stop Lamp Switch, Auto Transmission Shift Lever
AIR BAG		10 A	SRS (Supplemental Restraint System) Control Module
FRT WIPER2	<sup>2</sup> 	25 A	Engine Room Block (Wiper 1 Relay), Front Wiper Motor
MDPS <sup>1</sup>	 <sup>1</sup>	7.5 A	MDPS (Motor Driven Power Steering) Unit
A/BAG IND	<sup>IND</sup> 	7.5 A	Cluster
CLUSTER	<b>CLUSTER</b>	7.5 A	Instrument Cluster, Head-Up Display
A/C1	<sup>1</sup> <b>A/C</b>	7.5 A	Engine Room Block (Blower Relay), Air Conditioner Control Module
POWER OUTLET2	<sup>2</sup> <b>POWER OUTLET</b>	20 A	Front Power Outlet #1

Fuse Name	Symbol	Fuse rating	Circuit Protected
MODULE 2	<sup>2</sup> MODULE	10 A	USB Charger, IBU (Integrated Body Control Unit), Audio, Surround View Monitor, Audio/Video & Navigation Head Unit, Air Purifier, AMP (Amplifier), Power Outside Mirror Switch
A/C2	<sup>2</sup> A/C	10 A	Air Conditioner Control Module
MODULE 7	<sup>2</sup> MODULE	7.5 A	Head Lamp LH/RH, IBU (Integrated Body Control Unit), Crash Pad Switch, Front Air Ventilation Seat Control Module
WASHER		15 A	Multifunction Switch
POWER OUTLET1	<sup>1</sup> POWER OUTLET	15 A	Front Power Outlet #1
MODULE4	<sup>4</sup> MODULE	7.5 A	Electronic Parking Brake, ESP Switch (Electronic Stability Program Control Module), Lane Keeping Assist System Unit, Dosing Valve Control Unit, IBU (Integrated Body Control Unit), Clutch Sensor (Smartstream G1.5), Front Radar
SUNROOF2	<sup>2</sup> 	20 A	Sunroof Unit





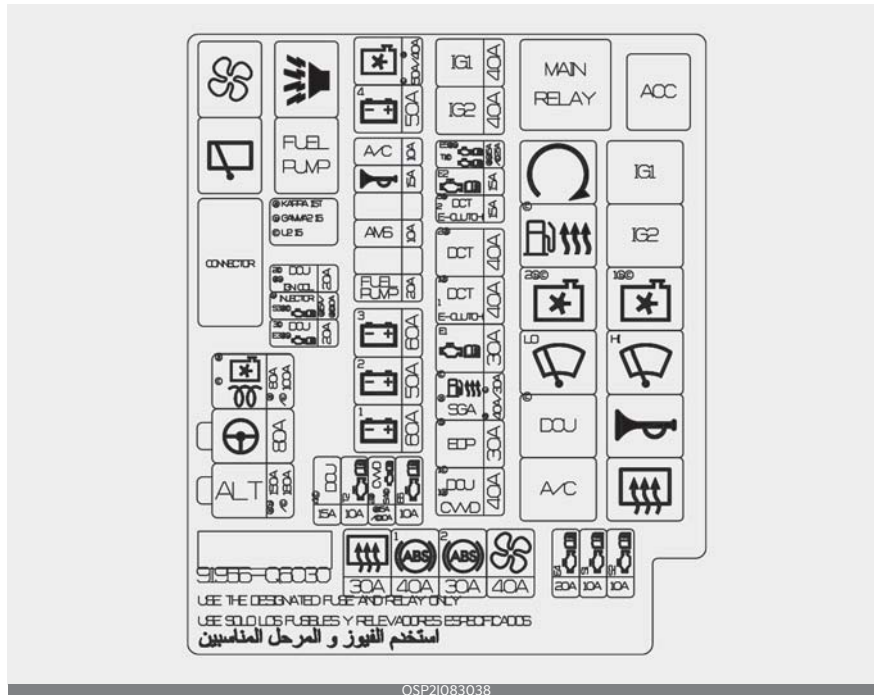







\* 1: MDPS (Motor Driven Power Steering) is the same as EPS (Electric Power Steering).

### Engine compartment fuse panel



Refer to the following table for a description of the fuse.











Fuse Name	Symbol	Fuse rating	Circuit Protected
ALT	<b>ALT</b>	150 A	[ALL] Alternator, Rear Defogger Relay, ESP (Electronic Stability Program) Control Module, ESP (Electronic Stability Program) Control Module, Blower Relay
		180 A	[(Diesel) 1.5 VGT] Glow Relay Unit, Dosing Valve Control Unit Relay
MDPS		80 A	MDPS (Motor Driven Power Steering) Unit
GLOW		100 A	[(Diesel) 1.5 VGT] Glow Relay Unit
RR HTD		30 A	Rear Defogger Relay
ABS1	<sup>1</sup>	40 A	ESP (Electronic Stability Program) Control Module
ABS2	<sup>2</sup>	30 A	ESP (Electronic Stability Program) Control Module
BLOWER		40 A	Blower Relay
ECU4		20 A	ECM (Engine Control Module), PCM (Power train Control Module)
SENSOR 1		10 A	[ALL] Fuel Pump Relay [(Diesel) 1.5 VGT] Inlet Metering Unit
SENSOR 2		10 A	[ALL] Air Conditioner Relay [Smartstream G1.5 T-GDi] Purge Control Solenoid Valve, RCV, V Oil Pump, Oil Control Valve, Oxygen Sensor Up & Down [Smartstream G1.5] Purge Control Solenoid Valve, Cooling Fan Hi Relay, Cooling Fan Lo Relay, VIS Solenoid, Oil Control Valve, Oxygen Sensor Up & Down [(Diesel) 1.5 VGT] Fuel Heater Relay, Cam Position Sensor, Cooling Fan Hi Relay, Cooling Fan Lo Relay, Stop Lamp Switch Lambda Up & Down
DCU1	<sup>1</sup> <b>DCU</b>	40 A	[(Diesel) 1.5 VGT] Dosing Valve Relay, Dosing Valve Control Unit
EOP	<b>EOP</b>	30 A	[Smartstream G1.5] Electronic Oil Pump (CVT ISG Spec only)
FULL HTR		30 A	[(Diesel) 1.5 VGT] Fuel Heater Relay
ECU1		30 A	Main Relay
E-CLUTCH1	<sup>1</sup> <b>E-CLUTCH</b>	40 A	[Smartstream G1.5 T-GDi, (Diesel) 1.5 VGT] E-Clutch Unit
E-CLUTCH2	<sup>2</sup> <b>E-CLUTCH</b>	15 A	[Smartstream G1.5 T-GDi, (Diesel) 1.5 VGT] E-Clutch Unit
ECU2		15 A	ECM (Engine Control Module), PCM (Power train Control Module)
ECU5		15 A	ECM (Engine Control Module), PCM (Power train Control Module)
TCU1		25 A	ECM (Engine Control Module), PCM (Power train Control Module), TCM (Transmission Control Module)
IG2	<b>IG2</b>	40 A	Start Relay, IG2 Relay, Ignition Switch
IG1	<b>IG1</b>	40 A	ACC Relay, IG1 Relay, Ignition Switch

Fuse Name	Symbol	Fuse rating	Circuit Protected
B+1	<sup>1</sup> 	60 A	ICU Junction Block (Long Term Load Auto Cut Relay, Fuse - Hazard Switch, Data Link Connector, Stop Lamp Switch, IBU (Integrated Body Control Unit))
B+2	<sup>2</sup> 	50 A	ICU Junction Block (IPS4, IPS5, IPS6, IPS8, IPS9, IPS11, IPS12, IPS17)
B+3	<sup>3</sup> 	60 A	ICU Junction Block (IPS1, IPS2, IPS3, IPS7, IPS10, IPS13, IPS16, IPS18, IPS20)
FUEL PUMP	<b>FUEL PUMP</b>	20 A	Fuel Pump Relay
AMS	<b>AMS</b>	10 A	Battery Sensor
HORN		15 A	Horn Relay, B/A Horn Relay
A/C	<b>A/C</b>	10 A	Air Conditioner Relay
B+4	<sup>4</sup> 	50 A	ICU Junction Block (Fuse - Driver Seat Manual Switch, AMP (Amplifier), Power Window Relay RH, Driver Safety Power Window Module, Power Window Relay LH, Driver Safety Power Window Module, Front Air Ventilation Seat Control Module, Sunroof Unit, Tail Gate Relay)
C/FAN		40 A	[Smartstream G1.5] Cooling Fan 2 Relay, Cooling Fan 1 Relay
C/FAN		50 A	[(Diesel) 1.5 VGT] Cooling Fan 2 Relay, Cooling Fan 1 Relay
C/FAN		80 A	[Smartstream G1.5 T-GDI] Cooling Fan Motor
ECU6	<sup>E6</sup> 	10 A	ECM (Engine Control Module), PCM (Power train Control Module)
SENSOR 4	<sup>S4</sup> 	10 A	[(Diesel) 1.5 VGT] Fuel Water Sensor, Glow Relay Unit [Smartstream G1.5 T-GDI] CVVD Actuator
TCU2	<sup>T2</sup> 	10 A	[Smartstream G1.5 T-GDI] Inhibitor Switch (Gear Switch) [Auto Transmission], Electronic Oil Pump [Auto Transmission] [(Diesel) 1.5 VGT] Inhibitor Switch (Gear Switch) [Auto Transmission], TCM (Transmission Control Module) [Auto Transmission] [(Diesel) 1.5 VGT] E-Clutch Unit [Clutchless Manual]
DCU4	<sup>4</sup> <b>DCU</b>	15 A	[(Diesel) 1.5 VGT] Dosing Valve Control Unit
DCU3	<sup>3</sup> <b>DCU</b>	20 A	[(Diesel) 1.5 VGT] Dosing Valve Control Unit
ECU3	<sup>E3</sup> 	20 A	ECM (Engine Control Module), PCM (Power train Control Module)
INJECTOR	<b>INJECTOR</b>	15 A	[Smartstream G1.5] Injector #1/#2/#3/#4
SENSOR 3	<sup>S3</sup> 	10 A	[(Diesel) 1.5 VGT] Mass Air Flow Sensor, PM Sensor, Electronic VGT (Variable Geometry Turbocharger) Actuator, EGR Cooling Bypass Solenoid Valve [Smartstream G1.5 T-GDI] Cooling Fan Motor
IGN COIL	<b>IGN COIL</b>	20 A	Ignition Coil #1/#2/#3/#4, Condenser
DCU2	<sup>2</sup> <b>DCU</b>	20A	[(Diesel) 1.5 VGT] Dosing Valve Control Unit

Fuse Name	Symbol	Fuse rating	Circuit Protected
SGA	<b>SGA</b>	40 A	[Smartstream G1.5 T-GDi] Smart Gear Actuator
DCT1	<sup>4</sup> <b>DCT</b>	40 A	[Smartstream G1.5 T-GDi] Transmission Control Module (TCM)
DCT2	<sup>2</sup> <b>DCT</b>	40 A	[Smartstream G1.5 T-GDi] Transmission Control Module (TCM)
DCT3	<sup>3</sup> <b>DCT</b>	15 A	[Smartstream G1.5 T-GDi] Transmission Control Module (TCM)
CWD1	<sup>4</sup> <b>CWD</b>	40 A	[Smartstream G1.5 T-GDi] CWD Actuator
CWD2	<sup>2</sup> <b>CWD</b>	15 A	[Smartstream G1.5 T-GDi] CWD Actuator



Refer to the following table for the relay type.

Relay Name	Symbol	Type
Main Relay	<b>MAIN RELAY</b>	MINI
Start Relay		MICRO
Fuel Heater Relay		MICRO
Cooling Fan 2 Relay	<sup>2</sup> 	MICRO
Wiper 1 Relay	<sup>1</sup> 	MICRO
DCU Relay	<b>DCU</b>	MICRO
A/C Relay	<b>A/C</b>	MICRO
ACC Relay	<b>ACC</b>	MICRO
IG1 Relay	<b>IG1</b>	MICRO
IG2 Relay	<b>IG2</b>	MICRO
Cooling Fan 1 Relay	<sup>1</sup> 	MICRO
Wiper 2 Relay	<sup>2</sup> 	MICRO
Horn Relay		MICRO
Rear Defogger Relay		MICRO
Blower Relay		MICRO
Rear Wiper Relay		MICRO
B/A Horn Relay		MICRO
Fuel Pump Relay	<b>FUEL PUMP</b>	MICRO

## Light bulbs

Light bulbs are installed in various parts of the vehicle to provide lighting inside and outside the vehicle as well as to alert other vehicles.

### Bulb replacement precaution

Please keep extra bulbs on hand with appropriate wattage ratings in case of emergencies.

Refer to "Bulb wattage" on page 9-7.

When changing lamps, first turn off the vehicle at a safe place, firmly apply the parking brake and detach the battery's negative (-) terminal.

### WARNING

#### Working on the lights

Prior to working on the light, firmly apply the parking brake, ensure that turn the ignition switch and turn off the lights to avoid sudden movement of the vehicle and burning your fingers or receiving an electric shock.

Use only bulbs of the specified wattage.

### CAUTION

#### Light replacement

Be sure to replace the burned-out bulb with one of the same wattage rating. Otherwise, it may cause damage to the fuse or electric wiring system.

Fully install light bulbs and any parts used to secure them. Failure to do so may result in heat damage, fire, or water entering the headlight unit. This may damage the headlights or cause condensation to build up on the lens. To prevent damage or fire, make sure bulbs are fully seated and locked.

**⚠ CAUTION****Headlamp Lens**

To prevent damage, do not clean the headlamp lens with chemical solvents or strong detergents.

**\* NOTICE**

- If the light bulb or lamp connector is removed whilst the lamp is still on, the fuse box's electronic system may log it as a malfunction. Therefore, a lamp malfunction incident may be recorded as a Diagnostic Trouble Code (DTC) in the fuse box.
- It is normal for an operating lamp to flicker momentarily. This is due to a stabilization function of the vehicle's electronic control device. If the lamp lights up normally after momentarily blinking, then it is functioning as normal.

However, if the lamp continues to flicker several times or turns off completely, there may be an error in the vehicle's electronic control device. So we recommend that you have the vehicle checked by an authorised Kia dealer immediately.

**\* NOTICE**

We recommend that the headlight aiming be adjusted by an authorised Kia dealer after an accident or after the headlight assembly is reinstalled.

**\* NOTICE**

You can find moisture inside the lens of lamps after a car wash or driving in the rain. It is a natural event caused by the temperature difference between the inside and the outside of the lamp and

does not mean a problem with its functions. The moisture inside the lamp would disappear if you drive the vehicle with the headlamp turned on, however, the level at which the moisture is removed may differ depending on the size / location / condition of the lamp. If the moisture continues to stay inside the lamp, have the vehicle checked by a professional workshop. Kia recommends to visit an authorised Kia dealer/service partner.

If you don't have the necessary tools, the correct bulbs and the expertise, consult a professional workshop. Kia recommends to visit an authorised Kia dealer/service partner. In many cases, it is difficult to replace vehicle light bulbs because other parts of the vehicle must be removed before you can get to the bulb. This is especially true if you have to remove the headlamp assembly to get to the bulb(s).

Removing/installing the headlamp assembly can result in damage to the vehicle. If non-genuine parts or standard bulbs are used, it may lead to blowing a fuse or other wiring damages.

Do not install extra lamps or LEDs to the vehicle. If additional lights are installed, it may lead to lamp malfunctions and flickering. Additionally, the fuse box and other wiring may be damaged.

**8**

### Light bulb position (Front)

Headlamp - Type A



Fog lamp - Type A



Headlamp - Type B

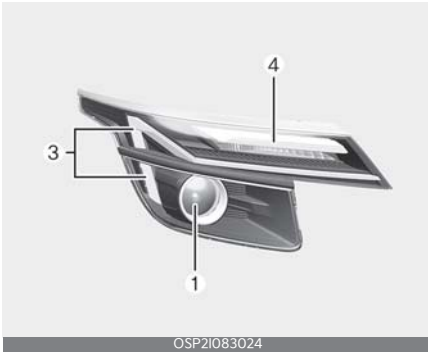

Fog lamp - Type B



Headlamp - Type C

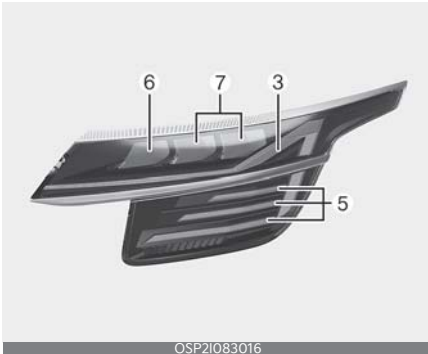

Position lamp



- 1. Headlamp (High & Low) (Bulb type)
- 2. Position lamp / Daytime running lamp (Bulb type)

**Maintenance**

**Light bulbs**

- 3. Position lamp / Daytime running lamp (LED type)
- 4. Turn signal lamp (Bulb type)
- 5. Turn signal lamp (LED type)
- 6. Headlamp (High) (LED type)
- 7. Headlamp (Low) (LED type)
- 8. Front fog lamp (Bulb type)
- 9. Front fog lamp (LED type)
- 10. Position lamp (auxiliary) (LED type)

**Light bulb position (Rear)**

Rear combination lamp - Type A

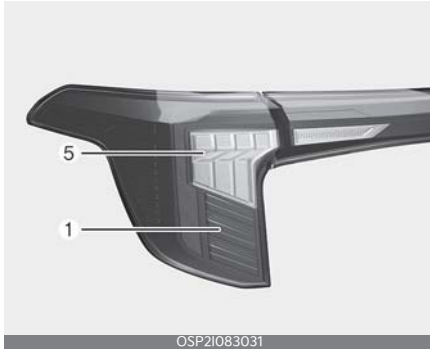

OSP21083031

Rear combination lamp - Type B

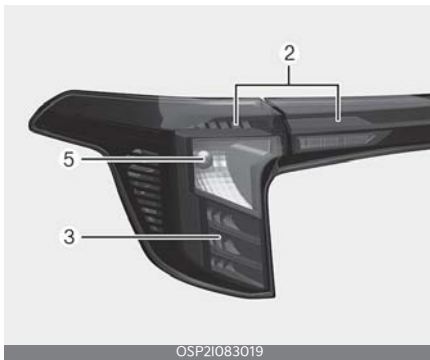

OSP21083019

Rear combination lamp - Type C



OSP21083032

Back up lamp - Type A



OSP21083034

Back up lamp - Type B



OSP21083025

8

License Plate lamp



OSP2I083042

High Mounted Stop Lamp (HMSL)



OSP2072080\_nn

1. Tail lamp/Stop lamp (Bulb type)
2. Tail lamp (LED type)
3. Stop lamp (LED type)
4. Back up lamp (Bulb type)
5. Rear turn signal lamp (Bulb type)
6. Rear turn signal lamp (LED Sequential type)
7. License plate lamp (Bulb type)
8. High mounted stop lamp (Bulb type)

Light bulb position (Side)



OSP2079035



OSP2I079176

1. Side direction indicator lamp (Bulb type)
2. Side repeater lamp (LED type)

Headlamp bulb



OSK3078081NR

**⚠ WARNING****Halogen bulbs**

Handle halogen bulbs with care.

- Halogen bulbs contain pressurized gas that will produce flying pieces of glass if broken.
- Always handle them carefully, and avoid scratches and abrasions. If the bulbs are lit, avoid contact with liquids. Never touch the glass with bare hands. Residual oil may cause the bulb to overheat and burst when lit. A bulb should be operated only when installed in a headlamp.
- If a bulb becomes damaged or cracked, replace it immediately and carefully dispose of it.
- Wear eye protection when changing a bulb. Allow the bulb to cool down before handling it.

### Replacing headlamp (low/high) / turn signal lamp / position lamp / daytime running lamp bulb (bulb type) (headlamp type A)



1. Headlamp (low and high)
2. Turn signal lamp
3. Position lamp / daytime running lamp

To prepare replacing the lamp bulb:

1. Open the bonnet.

To replace the headlamp (low/high) bulb:

1. Remove the headlight bulb cover by turning it counterclockwise.
2. Disconnect the headlight bulb socket-connector.
3. Unsnap the headlight bulb retaining wire by depressing the end and pushing it upward.
4. Remove the bulb from the headlight assembly.
5. Install a new headlight bulb and snap the headlight bulb retaining wire into position by aligning the wire with the groove on the bulb.
6. Connect the headlight bulb socket connector.
7. Install the headlight bulb cover by turning it clockwise.

To replace the turn signal lamp, position lamp, daytime running lamp bulb:

1. Remove the socket from the assembly by turning the socket counterclockwise until the tabs on the socket align with the slots on the assembly.
2. Insert a new bulb by inserting it into the socket and rotating it until it locks into place.
3. Install the socket in the assembly by aligning the tabs on the socket with the slots in the assembly.
4. Push the socket into the assembly and turn the socket clockwise.

### Replacing headlamp (low/high) / turn signal lamp bulb (bulb type) (headlamp type B)



1. Headlamp (low and high)

2. Turn signal lamp

To prepare replacing the lamp bulb:

1. Open the bonnet.

To replace the headlamp (low/high) bulb:

1. Remove the headlight bulb cover by turning it counterclockwise.
2. Disconnect the headlight bulb socket-connector.
3. Unsnap the headlight bulb retaining wire by depressing the end and pushing it upward.
4. Remove the bulb from the headlight assembly.
5. Install a new headlight bulb and snap the headlight bulb retaining wire into position by aligning the wire with the groove on the bulb.
6. Connect the headlight bulb socket connector.
7. Install the headlight bulb cover by turning it clockwise.

To replace the turn signal lamp:

1. Remove the socket from the assembly by turning the socket counterclock-

wise until the tabs on the socket align with the slots on the assembly.

2. Insert a new bulb by inserting it into the socket and rotating it until it locks into place.
3. Install the socket in the assembly by aligning the tabs on the socket with the slots in the assembly.
4. Push the socket into the assembly and turn the socket clockwise.

### Replacing position lamp / daytime running lamp (LED type) (headlamp type B)

If the position lamp / daytime running lamp LED (1) does not operate, we recommend that the system be checked by a professional workshop. Kia recommends to visit an authorised Kia dealer/service partner.



The LED lamps cannot be replaced as a single component because it is an integrated unit. The LED lamps have to be replaced with the unit.

A skilled technician should check or repair the position lamp / daytime running lamp (LED), for it may damage related parts of the vehicle.

### Replacing headlamp (high and low) / position lamp / daytime

### running lamp / turn signal lamp (LED type) (headlamp type C)

If the position lamp / daytime running lamp LED does not operate, we recommend that the system be checked by a professional workshop. Kia recommends to visit an authorised Kia dealer/service partner.



OSP21083021

The LED lamps cannot be replaced as a single component because it is an integrated unit. The LED lamps have to be replaced with the unit.

A skilled technician should check or repair the position lamp / daytime running lamp (LED), for it may damage related parts of the vehicle.

### Replacing position lamp (auxiliary) (LED type)

If the auxiliary lamp LED (1) does not operate, we recommend that the system be checked by a professional workshop. Kia recommends to visit an authorised Kia dealer/service partner.



OSP21079065

The LED lamps cannot be replaced as a single component because it is an integrated unit. The LED lamps have to be replaced with the unit.

A skilled technician should check or repair the auxiliary lamp (LED), for it may damage related parts of the vehicle.

### Replacing front fog lamp (bulb/LED type)

If the front fog lamp (type A, B) does not operate, we recommend that the system be checked by a professional workshop. Kia recommends to visit an authorised Kia dealer/service partner.

Type A



OSP2079040



Type B



### Replacing side repeater lamp (LED Type) bulb

If the side repeater lamp LED (1), does not operate, we recommend that the system be checked by a professional workshop. Kia recommends to visit an authorised Kia dealer/service partner.



The LED lamps cannot be replaced as a single component because it is an integrated unit. The LED lamps have to be replaced with the unit.

A skilled technician should check or repair the side repeater lamp (LED), for it may damage related parts of the vehicle. We recommend that the system be checked by a professional workshop. Kia recommends to visit an authorised Kia dealer/service partner.

### Replacing side repeater lamp bulb (bulb type)



1. Remove the lamp assembly from the vehicle by prying the lens and pulling the assembly out.
2. Disconnect the bulb electrical connector.
3. Separate the socket and the lens parts by turning the socket counterclockwise until the tabs on the socket align with the slots on the lens part.
4. Remove the bulb by pulling it straight out.
5. Insert a new bulb in the socket.
6. Reassemble the socket and the lens part.
7. Connect the bulb electrical connector.
8. Reinstall the lamp assembly to the body of the vehicle.

## Replacing rear turn signal lamp / tail and stop lamp bulb (bulb type) (rear combination lamp type A, B)

Type A

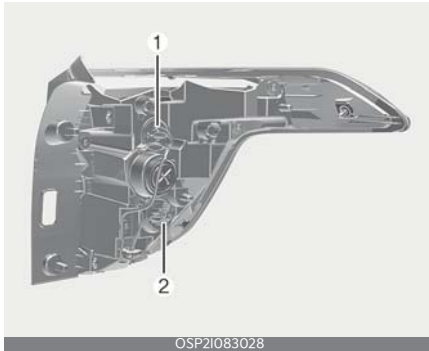

Type B

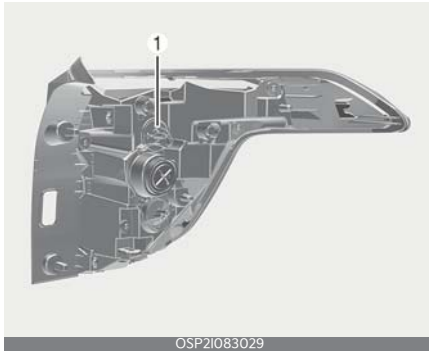

1. Turn signal lamp
  2. Tail and stop lamp
- To place the lamp bulb:

1. Open the tailgate.
2. Loosen the light assembly retaining screws with a cross-tip screwdriver.
3. Remove the rear combination light assembly from the body of the vehicle.
4. Remove the socket from the assembly by turning the socket counterclock-

- wise until the tabs on the socket align with the slots on the assembly.
5. Remove the bulb from the socket by pressing it in and rotating it counterclockwise until the tabs on the bulb align with the slots in the socket.
6. Pull the bulb out of the socket.
7. Insert a new bulb by inserting it into the socket and rotating it until it locks into place.
8. Install the socket in the assembly by aligning the tabs on the socket with the slots in the assembly.
9. Push the socket into the assembly and turn the socket clockwise.
10. Reinstall the light assembly to the body of the vehicle.

## Replacing stop / tail (LED type) rear combination lamp type B

If the stop lamp (1) or tail and stop lamp (2) does not operate, we recommend that the system be checked by a professional workshop. Kia recommends to visit an authorised Kia dealer/service partner.

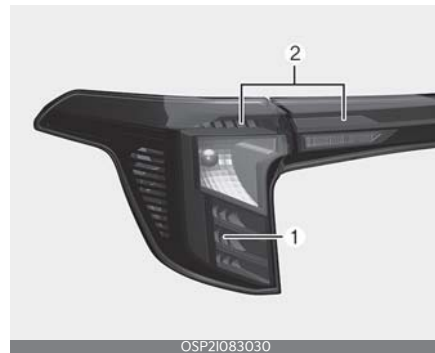

The LED lamps cannot be replaced as a single component because it is an integrated unit. The LED lamps have to be replaced with the unit.

A skilled technician should check or repair the LED lamps, for it may damage related parts of the vehicle.

### Replacing stop lamp (LED type), Tail (LED type) & T/Sig (LED type) in Rear Combination lamp type C

If the stop lamp (1) or tail lamp (2) and Turn signal lamp (3) does not operate, we recommend that system be checked by professional workshop. Kia recommends to visit an authorised Kia dealer/Service partner.

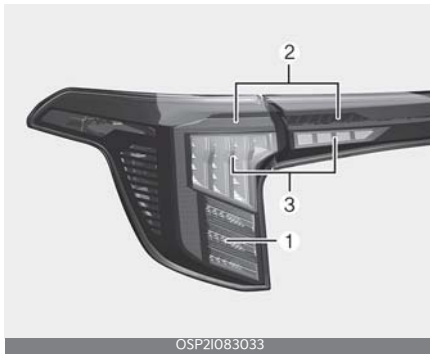

The LED lamps cannot be replaced as a single component because it is an integrated unit. The LED lamps have to be replaced with the unit.

A skilled technician should check or repair the LED lamps, for it may damage related parts of the vehicle.

### Replacing High Mounted Stop Lamp bulb (bulb type)

1. Open the tailgate.



2. Remove the three round head cap nut fixing the high mounted stop lamp using a wrench.
3. Pull out the high mounted stop lamp assembly and unplug the connector.

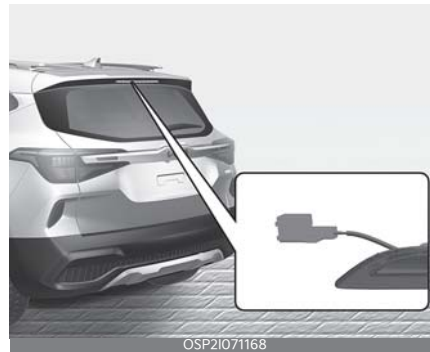

4. Remove the cover from the assembly.



5. Pull out the bulb from the socket.

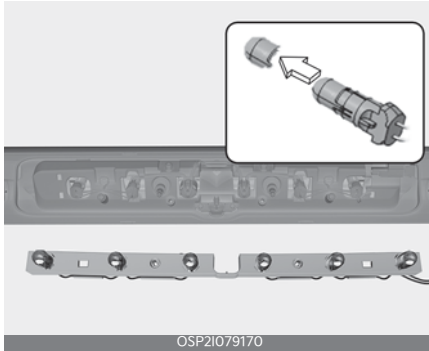

6. Insert a new bulb in the socket.
7. Install the high mounted stop lamp in the reverse order of removal.

### Replacing license plate lamp bulb



1. First remove tailgate trim from tailgate assy using tool.
2. Disassemble tailgate garnish by unbolting 4 nuts.
3. Take out the tailgate garnish.
4. Remove bulb socket and change the bulb.
5. And follow the same procedure for assembly again

### Replacing B/Up Lamp in Type A & Type B

If the light does not operate, we recommend that the vehicle to be checked by an authorized KIA dealer.

### Replacing map lamp (bulb type) bulb

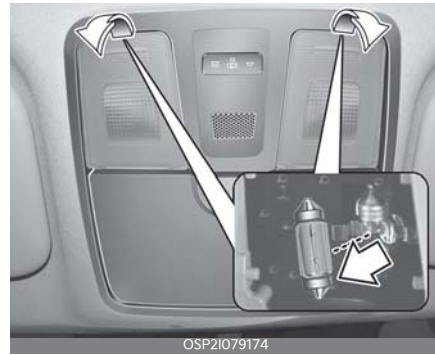

#### ⚠ WARNING

Prior to working on the Interior lamps, ensure that the "OFF" button is depressed to avoid burning your fingers or receiving an electric shock.

1. Using a flat-blade screwdriver, gently pry the lens cover from lamp housing.
2. Remove the bulb by pulling it straight out.
3. Install a new bulb in the socket.
4. Align the lens cover tabs with the lamp housing notches and snap the lens into place.

#### \* NOTICE

Be careful not to dirty or damage the lens, lens tab, and plastic housings.

### Replacing map lamp (LED type) bulb

If the map lamp (LED) does not operate, we recommend that the system be checked by a professional workshop. Kia recommends to visit an authorised Kia dealer/service partner.



The LED lamps cannot be replaced as a single component because they are part of an integrated unit. The LED lamps have to be replaced with the unit.

A skilled technician should check or repair the map lamp (LED), for it may damage related parts of the vehicle.

We recommend that the system be checked by a professional workshop. Kia recommends to visit an authorised Kia dealer/service partner.

### Replacing room lamp (bulb type) bulb

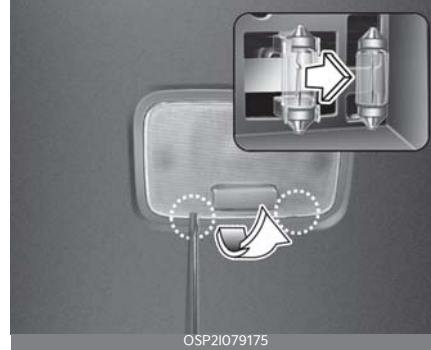

#### ⚠ WARNING

Prior to working on the Interior lamps, ensure that the "OFF" button is depressed to avoid burning your fingers or receiving an electric shock.

1. Using a flat-blade screwdriver, gently pry the lens cover from lamp housing.
2. Remove the bulb by pulling it straight out.
3. Install a new bulb in the socket.
4. Align the lens cover tabs with the lamp housing notches and snap the lens into place.

#### \* NOTICE

Be careful not to dirty or damage the lens, lens tab, and plastic housings.

### Replacing room lamp (LED type) bulb

If the Room lamp (LED) does not operate, have the vehicle checked by a professional workshop. Kia recommends to visit an authorised Kia dealer/service partner.



The LED lamps cannot be replaced as a single component because they are part of an integrated unit. The LED lamps have to be replaced with the unit.

A skilled technician should check or repair the Room lamp (LED), for it may damage related parts of the vehicle.

### Replacing luggage room lamp (bulb type) bulb



1. Using a flat-blade screwdriver, gently pry the lens cover from lamp housing.
2. Remove the bulb by pulling it straight out.
3. Install a new bulb in the socket.
4. Align the lens cover tabs with the lamp housing notches and snap the lens into place.

### ⚠ CAUTION

Be careful not to dirty or damage the lens, lens tab, and plastic housings.

## Appearance care

Use the information in the following sections to keep the exterior and interior of your vehicle clean.

### Exterior care

Use the information in the following sections to maintain the exterior of your vehicle. Keeping the exterior clean is not only aesthetically pleasing, but it also helps to prolong the life of the vehicle.

#### \* NOTICE

If you park the vehicle around a stainless signboard or windscreen building etc., the plastic exterior trim (bumper, spoiler, garnish, lamp, outside mirror etc.) may be damaged by reflected sunlight from the external structure. To avoid damaging the plastic exterior trim, park the vehicle away from the areas where the reflected light may occur or use a vehicle cover. (Depending on the vehicle, the type of exterior trim applied such as spoiler may differ.)

### Exterior general caution

It is very important to follow the label directions when using any chemical cleaner or polish. Read all warning and caution statements that appear on the label.

### Finish maintenance

#### Washing

To help protect your vehicle's finish from rust and deterioration, wash it thoroughly and frequently at least once a month with lukewarm or cold water.

If you use your vehicle for off-road driving, you should wash it after each off-

road trip. Pay special attention to the removal of any accumulation of salt, dirt, mud, and other foreign materials. Make sure the drain holes in the lower edges of the doors and rocker panels are kept clear and clean.

Insects, tar, tree sap, bird droppings, industrial pollution and similar deposits can damage your vehicle's finish if not removed immediately.

Even prompt washing with plain water may not completely remove all these deposits. A mild soap, safe for use on painted surfaces, may be used.

After washing, rinse the vehicle thoroughly with lukewarm or cold water. Do not allow soap to dry on the finish.

After washing the vehicle, test the brakes whilst driving slowly to see if they have been affected by water. If braking performance is impaired, dry the brakes by applying them lightly whilst maintaining a slow forward speed.

#### ⚠ CAUTION

- Do not use strong soap, chemical detergents or hot water, and do not wash the vehicle in direct sunlight or when the body of the vehicle is warm.
- Be careful when washing the side windows of your vehicle, especially with high-pressure water. Water may leak through the windows and wet the interior.
- To prevent damage to the plastic parts and lamps, do not clean with chemical solvents or strong detergents.

#### ⚠ WARNING

After washing the vehicle, test the brakes whilst driving slowly to see if they have been affected by water. If braking

performance is impaired, dry the brakes by applying them lightly whilst maintaining a slow forward speed.

### High-pressure washing

When using high-pressure washers, make sure to maintain sufficient distance from the vehicle.

Insufficient clearance or excessive pressure can lead to component damage or water penetration.

Do not spray the camera, sensors or its surrounding area directly with a high pressure washer. Shock applied from high pressure water may cause the device to not operate normally.

Do not bring the nozzle tip close to boots (rubber or plastic covers) or connectors as they may be damaged if they come into contact with high pressure water.

### ⚠ CAUTION

#### Wetting engine compartment



- Water washing in the engine compartment including high pressure water washing may cause the failure of electrical circuits located in the engine compartment.
- Never allow water or other liquids to come in contact with electrical/elec-

tronic components and air duct inside the vehicle as this may damage them.

### \* NOTICE

#### Matte paint finish vehicle

Automatic car wash which uses rotating brushes should not be used as this can damage the surface of your vehicle. A steam cleaner which washes the vehicle surface at high temperature may result the oil to adhere and leave stains that is difficult to remove. Use a soft cloth (e.g. microfiber towel or sponge) when washing your vehicle and dry with a microfiber towel. When you hand wash your vehicle, you should not use a cleaner that finishes with wax. If the vehicle surface is too dirty (sand, dirt, dust, contaminant, etc.), clean the surface with water before washing the car.

### Waxing

Wax the vehicle when water will no longer bead on the paint.

Always wash and dry the vehicle before waxing. Use a good quality liquid or paste wax, and follow the manufacturer's instructions. Wax all metal trim to protect it and to maintain its luster.

Removing oil, tar, and similar materials with a spot remover will usually strip the wax from the finish. Be sure to re-wax these areas even if the rest of the vehicle does not yet need waxing.

Be careful not to touch the lens when waxing the lamps.

### ⚠ CAUTION

#### Drying vehicle

- Wiping dust or dirt off the body with a dry cloth will scratch the finish.



- Do not use steel wool, abrasive cleaners, acid detergents or strong detergents containing high alkaline or caustic agents on chrome-plated or anodized aluminum parts. This may result in damage to the protective coating and cause discoloration or paint deterioration.

### \* NOTICE

#### Matte paint finish vehicle

Do not use any polish protector such as a detergent, an abrasive and a polish. In case wax is applied, remove the wax immediately using a silicon remover and if any tar or tar contaminant is on the surface use a tar remover to clean. However, be careful not to apply too much pressure on the painted area.

#### Finish damage repair

Deep scratches or stone chips in the painted surface must be repaired promptly. Exposed metal will quickly rust and may develop into a major repair expense.

### \* NOTICE

If your vehicle is damaged and requires any metal repair or replacement, be sure the body shop applies anti-corrosion materials to the parts repaired or replaced.

### \* NOTICE

#### Matte paint finish vehicle

In case of matte paint finish vehicles, it is impossible to modify only the damaged area and repair of the whole part is necessary. If the vehicle is damaged and painting is required, have your vehicle

maintained and repaired by a professional workshop. Kia recommends to visit an authorised Kia dealer/service partner.

Take extreme care, as it is difficult to restore the quality after the repair.

#### Bright-metal maintenance

To remove road tar and insects, use a tar remover, not a scraper or other sharp object.

To protect the surfaces of bright metal parts from corrosion, apply a coating of wax or chrome preservative and rub to a high luster.

During winter weather or in coastal areas, cover the bright metal parts with a heavier coating of wax or preservative. If necessary, coat the parts with non-corrosive petroleum jelly or other protective compound.

#### Underbody maintenance

Corrosive materials used for ice and snow removal and dust control may collect on the underbody. If these materials are not removed, accelerated rusting can occur on underbody parts such as the fuel lines, frame, floor pan and exhaust system, even though they have been treated with rust protection.

Thoroughly flush the vehicle underbody and wheel openings with lukewarm or cold water once a month, after off-road driving and at the end of each winter. Pay special attention to these areas because it is difficult to see all the mud and dirt. It will do more harm than good to wet down the road grime without removing it. The lower edges of the doors, rocker panels, and frame members have drain holes that should not

clog with dirt; trapped water in these areas can cause rusting.

**Aluminum wheel maintenance**

The aluminum wheels are coated with a clear protective finish.

- Do not use any abrasive cleaner, polishing compound, solvent, or wire brushes on aluminum wheels. They may scratch or damage the finish.
- Clean the wheel when it has cooled.
- Use only a mild soap or neutral detergent, and rinse thoroughly with water. Also, be sure to clean the wheels after driving on salted roads. This helps prevent corrosion.
- Avoid washing the wheels with high speed vehicle wash brushes.
- Do not use any alkaline or acid detergents. It may damage and corrode the aluminum wheels coated with a clear protective finish.

**Corrosion protection**

**Protecting your vehicle from corrosion**

By using the most advanced design and construction practices to combat corrosion, we produce vehicles of the highest quality. However, this is only part of the job. To achieve the long-term corrosion resistance your vehicle can deliver, the owner's cooperation and assistance is also required.

**Common causes of corrosion**

The most common causes of corrosion on your vehicle are:

- Road salt, dirt and moisture that is allowed to accumulate underneath the vehicle.

- Removal of paint or protective coatings by stones, gravel, abrasion or minor scrapes and dents which leave unprotected metal exposed to corrosion.

**High-corrosion areas**

If you live in an area where your vehicle is regularly exposed to corrosive materials, corrosion protection is particularly important. Some of the common causes of accelerated corrosion are road salts, dust control chemicals, ocean air and industrial pollution.

**Moisture breeds corrosion**

Moisture creates the conditions in which corrosion is most likely to occur. For example, corrosion is accelerated by high humidity, particularly when temperatures are just above freezing. In such conditions, the corrosive material is kept in contact with the vehicle's surface by moisture that evaporates slowly.

Mud is particularly corrosive because it dries slowly and holds moisture in contact with the vehicle. Although the mud appears to be dry, it can still retain the moisture and promote corrosion.

High temperatures can also accelerate corrosion of parts that are not properly ventilated so the moisture can be dispersed. For all these reasons, it is particularly important to keep your vehicle clean and free of mud or accumulations of other materials. This applies not only to the visible surfaces but particularly to the underside of the vehicle.

**To help prevent corrosion**

You can help prevent corrosion from beginning by observing the following:

### Keep your vehicle clean

The best way to prevent corrosion is to keep your vehicle clean and free of corrosive materials. Attention to the underside of the vehicle is particularly important.

If you live in a high-corrosion area — where road salts are used, near the ocean, areas with industrial pollution, acid rain, etc.—, you should take extra care to prevent corrosion. In winter, hose off the underside of your vehicle at least once a month and be sure to clean the underside thoroughly when winter is over.

When cleaning underneath the vehicle, give particular attention to the components under the fenders and other areas that are hidden from view. Do a thorough job; just dampening the accumulated mud rather than washing it away will accelerate corrosion rather than prevent it. Water under high pressure and steam are particularly effective in removing accumulated mud and corrosive materials.

When cleaning lower door panels, rocker panels and frame members, be sure that drain holes are kept open so that moisture can escape and not be trapped inside to accelerate corrosion.

### Keep your garage dry

Don't park your vehicle in a damp, poorly ventilated garage. This creates a favorable environment for corrosion. This is particularly true if you wash your vehicle in the garage or drive it into the garage when it is still wet or covered with snow, ice or mud. Even a heated garage can contribute to corrosion unless it is well ventilated so moisture is dispersed.

### Keep paint and trim in good condition

Scratches or chips in the finish should be covered with "touch-up" paint as soon as possible to reduce the possibility of corrosion. If bare metal is showing through, the attention of a qualified body and paint shop is recommended.

Bird droppings: Bird droppings are highly corrosive and may damage painted surfaces in just a few hours. Always remove bird droppings as soon as possible.

### Don't neglect the interior

Moisture can collect under the floor mats and carpeting and cause corrosion. Check under the mats periodically to be sure the carpeting is dry. Use particular care if you carry fertilizers, cleaning materials or chemicals in the vehicle.

These should be carried only in proper containers and any spills or leaks should be cleaned up, flushed with clean water and thoroughly dried.

### Interior care

Use the information in the following sections to maintain the interior of your vehicle.

#### \* NOTICE

Interior general precautions

Prevent chemicals such as perfume, cosmetic oil, sun cream, hand cleaner, and air freshener from contacting the interior parts because they may cause damage or discoloration. If they do contact the interior parts, wipe them off immediately. If necessary, use a mixture of warm water and mild non-detergent cleaner (test all cleaners on a concealed

area before use). Use proper car cleaner to clean interior parts.

### ⚠ CAUTION

#### Electrical components

Never allow water or other liquids to come in contact with electrical/electronic components inside the vehicle as this may damage them.

### ⚠ CAUTION

#### Leather

When cleaning leather products (steering wheel, seats etc.), use neutral detergents or low alcohol content solutions. If you use high alcohol content solutions or acid/alkaline detergents, the colour of the leather may fade or the surface may get stripped off.

#### Interior general precautions

Prevent chemicals such as perfume, cosmetic oil, sun cream, hand cleaner, and air freshener from contacting the interior parts because they may cause damage or discoloration. If they do contact the interior parts, wipe them off immediately. If necessary, use a mixture of warm water and mild non-detergent cleaner (test all cleaners on a concealed area before use). Use proper car cleaner to clean interior parts.

#### Taking care of leather seats

- Vacuum the seat periodically to remove dust and sand on the seat. It will prevent abrasion or damage of the leather and maintain its quality.
- Wipe the leather seat cover often with dry or soft cloth.

- Sufficient use of a leather protective may prevent abrasion of the cover and helps maintain the colour. Be sure to read the instructions and consult a specialist when using leather coating or protective agents.
- Leather with bright colours (beige, cream beige) is easily contaminated and clear in appearance. Clean the seats frequently.
- Avoid wiping with wet cloth. It may cause the surface to crack.

#### Cleaning the leather seats

Remove all contaminations instantly. Refer to instructions below for removal of each contaminant.

- Cosmetic products (sunscreen, foundation, etc.)
  - Apply cleansing cream on a cloth and wipe the contaminated point. Wipe off the cream with a wet cloth and remove water with a dry cloth.
- Beverages (coffee, soft drink, etc.)
  - Apply a small amount of neutral detergent and wipe until contaminations do not smear.
- Oil
  - Remove oil instantly with absorbable cloth and wipe with stain remover for leather only.
- Chewing gum
  - Harden the gum with ice and remove gradually.

#### Fabric seat cover (if equipped)

Please clean the fabric seats regularly with a vacuum cleaner in consideration of fabric material characteristics. If they are heavily soiled with beverage stains, etc., use a suitable interior cleaner. To

prevent damage to seat covers, wipe off the seat covers down to the seams with a large wiping motion and moderate pressure using a soft sponge or microfiber cloth.

Velcro closures on clothing or sharp objects may cause snagging or scratches on the surface of the seats.

Make sure not to rub such objects against the surface.

## Cleaning the upholstery and interior trim

### Car interior surfaces

Remove dust and loose dirt from interior surfaces with a whisk broom or a vacuum cleaner. If necessary, clean interior surfaces with a mixture of warm water and mild non-detergent cleaner (test all cleaners on a concealed area before use).

### Fabric

Remove dust and loose dirt from fabric with a whisk broom or vacuum cleaner. Clean with a mild soap solution recommended for upholstery or carpets.

Remove fresh spots immediately with a fabric spot cleaner. If fresh spots do not receive immediate attention, the fabric can be stained and its colour can be affected. Also, its fire-resistant properties can be reduced if the material is not properly maintained.

Using anything but recommended cleaners and procedures may affect the fabric's appearance and fire-resistant properties.

## Cleaning the lap/shoulder belt webbing

Clean the belt webbing with any mild soap solution recommended for cleaning upholstery or carpet. Follow the instructions provided with the soap. Do not bleach or re-dye the webbing because this may weaken it.

## Cleaning the interior window glass

If the interior glass surfaces of the vehicle become fogged (that is, covered with an oily, greasy or waxy film), they should be cleaned with a glass cleaner. Follow the directions on the glass cleaner container.

### CAUTION

#### Rear window

Do not scrape or scratch the inside of the rear window. This may result in damage of the rear window defroster grid.

## Emission control system

The emission control system of your vehicle is covered by a written limited warranty. Please see the warranty information contained in the Warranty & Consumer Information manual in your vehicle.

Your vehicle is equipped with an emission control system to meet all applicable emission regulations. There are three emission control systems, as follows.

1. Crankcase emission control system
2. Evaporative emission control system
3. Exhaust emission control system

In order to assure the proper function of the emission control systems, it is recommended that you have your vehicle inspected and maintained by an authorised Kia dealer in accordance with the maintenance schedule in this manual.

### Caution for the Inspection and Maintenance Test (With Electronic Stability Control (ESC) system)

- To prevent the vehicle from misfiring during dynamometer testing, turn the ESC off by pressing the ESC switch.
- After dynamometer testing is completed, turn the ESC back on by pressing the ESC switch again.

### 1. Crankcase emission control system

The Positive Crankcase Ventilation system is employed to prevent air pollution caused by blow-by gases being emitted from the crankcase. This system supplies fresh filtered air to the crankcase through the air intake hose. Inside the

crankcase, the fresh air mixes with blow-by gases, which then pass through the Positive Crankcase Ventilation (PCV) valve into the induction system.

### 2. Evaporative emission control (including Onboard Refuelling Vapour Recovery (ORVR)) system

The evaporative emission control system is designed to prevent fuel vapours from escaping into the atmosphere. (The ORVR system is designed to allow the vapours from the fuel tank to be loaded into a canister whilst refuelling at the gas station, preventing the escape of fuel vapours into the atmosphere.)

#### Canister

Fuel vapours generated inside the fuel tank are absorbed and stored in the onboard canister. When the engine is running, the fuel vapours absorbed in the canister are drawn into the surge tank through the Purge Control Solenoid Valve.

#### Purge Control Solenoid Valve (PCSV)

The Purge Control Solenoid Valve (PCSV) is controlled by the Engine Control Module (ECM); when the engine coolant temperature is low during idling, the PCSV closes so that evaporated fuel is not taken into the engine. After the engine warms up during ordinary driving, the PCSV opens to introduce evaporated fuel to the engine.

### 3. Exhaust emission control system

The exhaust emission control system is a highly effective system which controls

exhaust emissions whilst maintaining good vehicle performance.

### Engine exhaust gas precautions (carbon monoxide)

- Carbon monoxide can be present with other exhaust fumes. Therefore, if you smell exhaust fumes of any kind inside your vehicle, have it inspected and repaired immediately. If you ever suspect exhaust fumes are coming into your vehicle, drive it only with all the windows fully open. Have your vehicle checked and repaired immediately.

#### **▲ WARNING**

##### **Exhaust**

Engine exhaust gases contain carbon monoxide (CO). Though colourless and odourless, it is dangerous and could be lethal if inhaled. Follow the instructions on this page to avoid CO poisoning.

- Do not operate the engine in confined or closed areas (such as garages) any more than what is necessary to move the vehicle in or out of the area.
- When the vehicle is stopped in an open area for more than a short time with the engine running, adjust the ventilation system (as needed) to draw outside air into the vehicle.
- Never sit in a parked or stopped vehicle for any extended time with the engine running.
- When the engine stalls or fails to start, excessive attempts to restart the engine may cause damage to the emission control system.

### Operating precautions for catalytic converters

#### **▲ WARNING**

##### **Catalytic converter**

Keep away from the catalytic converter and exhaust system whilst the vehicle is running or immediately thereafter. The exhaust and catalytic systems are very hot and may burn you.

#### **▲ WARNING**

##### **Fire**

- Do not park, idle or drive the vehicle over or near flammable objects, such as grass, vegetation, paper, leaves, etc. A hot exhaust system can ignite flammable items under your vehicle.
- Also, do not remove the heat sink around the exhaust system, do not seal the bottom of the vehicle or do not coat the vehicle for corrosion control. It may present a fire risk under certain conditions.

Your vehicle is equipped with a catalytic converter emission control device.

Therefore, the following precautions must be observed:

- Use only UNLEADED FUEL for petrol engines.
- Do not operate the vehicle when there are signs of engine malfunction, such as misfire or a noticeable loss of performance.
- Do not misuse or abuse the engine. Examples of misuse are coasting with the ignition off and descending steep grades in gear with the ignition off.
- Do not operate the engine at high idle speed for extended periods (5 minutes or more).

- Do not modify or tamper with any part of the engine or emission control system. All inspections and adjustments must be made by a professional workshop. Kia recommends to visit an authorised Kia dealer/service partner.
- Avoid driving with an extremely low fuel level. Running out of fuel could cause the engine to misfire, damaging the catalytic converter.

Failure to observe these precautions could result in damage to the catalytic converter and to your vehicle. Additionally, such actions could void your warranties.

### Petrol Particulate Filter (PPF) (if equipped)

The Petrol Particulate Filter (PPF) system removes the soot in the exhaust gas.

The PPF system automatically burns (or oxidizes) the accumulated soot in accordance with driving situations, unlike a disposable air filter.

In other words, the accumulated soot is automatically purged out by the engine control system and by the high exhaust-gas temperature at normal/ high driving speeds.

However, when the vehicle is continually driven at repeated short distances or driven at low speed for a long time, the accumulated soot may not be automatically removed because of low exhaust gas temperature. In this case, the accumulated soot may reach a certain amount regardless of the soot oxidization process, then the PPF lamp () will illuminate.

PPF Lamp stops illuminating, when the driving speed exceeds 80 km/h with engine rpm 1,500 ~ 4,000 and the gear in the 3rd position or above for approximately 30 minutes.

When the PPF lamp starts to blink or the warning message "check exhaust system" pops up even though the vehicle was driven as mentioned above, visit a professional workshop and check the PPF system. Kia recommends to visit an authorised Kia dealer/service partner. With the PPF lamp blinking for an extended period of time, it may damage the PPF system and lower the fuel economy.

### Diesel Particulate Filter (if equipped)

The Diesel Particulate Filter (DPF) system removes the soot in the exhaust gas.

Unlike a disposable air filter, the DPF system automatically burns (oxidizes) and removes the accumulated soot according to the driving condition. In other words, the active burning by engine control system and high exhaust gas temperature caused by normal/high driving condition burns and removes the accumulated soot. However, if the vehicle continues to be driven at repeated short distance or driven at low speed for a long time, the accumulated soot may not be automatically removed because of low exhaust gas temperature. More than a certain amount of soot deposited, the malfunction indicator light () illuminates.

When the malfunction indicator light blinks, it may stop blinking by driving the vehicle at more than 60 km/h (37 mph) or at more than second gear with 1,500



~ 2,500 engine rpm for a certain time (for about 25 minutes).

If the malfunction indicator light () continues to be blinked or the warning message "Check exhaust system" illuminates in spite of the procedure, visit a professional workshop and check the DPF system. Kia recommends to visit an authorised Kia dealer/service partner. If you continue to drive with the malfunction indicator light blinking for a long time, the DPF system can be damaged and fuel consumption can be worsen and engine durability can be worsen by oil dilution.

### CAUTION

#### Diesel Fuel (if equipped with DPF)

It is recommended to use the regulated automotive diesel fuel for diesel vehicle equipped with the DPF system.

If you use diesel fuel including high sulfur (more than 50 ppm sulfur) and unspecified additives, it can cause the DPF system to be damaged and white smoke can be emitted.

#### Lean NOx Trap

The Lean NOx Trap (LNT) system removes the nitrogen oxide in the exhaust gas. The smell can occur in the exhaust gas depending on the quality of the fuel and it can degrade NOx reduction performance, please use the regulated automotive diesel fuel.

- The LNT warning light () blinks if the LNT performance is degraded.

In this case, the warning light illuminates and the warning alarm sounds whilst showing a warning message "Self Regeneration" on the LCD display.

#### Self Regeneration Mode

If the warning message "Self Regeneration" is stored in inspection message tap, it is operable in LCD warning message page.

### WARNING

- Make sure the vehicle parked on safety zone (to avoid the flammables like grass and traffic accident).
- Check remained fuel above 1/5 of full level fuel gauge to prevent fuel overheat.
- Open the bonnet to prevent engine room overheat.
- Self regeneration should be done only when DPF indicator illuminates.

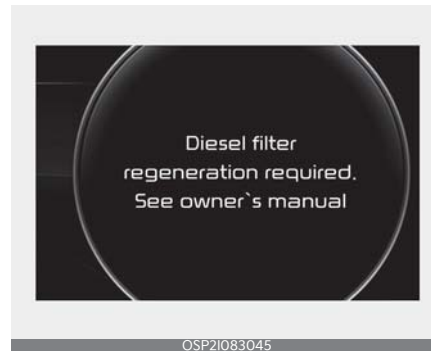

If the warning message "Diesel filter regeneration required, See owner's manual." appears on the LCD display, Self Regeneration is required.

#### To initiate Self Regeneration

1. Engage parking brake and shift lever at P state.
2. Turn on the engine.
3. Warm up the engine and check engine temperature gauge at the middle position.

4. Turn on the air conditioner and set the blower to the maximum.
5. Turn on the high beam.
6. Operate the rear defog function.
7. Hold the OK button on the LCD warning message page.

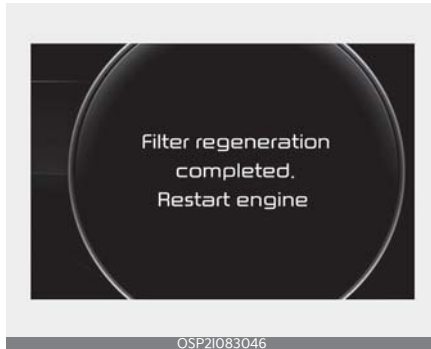

8. Turn off and turn on the engine again.

### Not Operating Condition

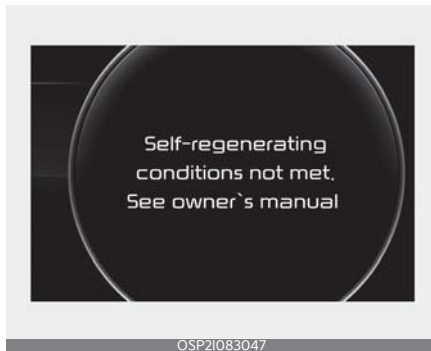

Under below condition, Diesel Catalyst regeneration process may be interrupted. (Engine RPM drops to idle state)

- Engine overheat or insufficient warm-up
- Shift lever change to D or R state-
- Acceleration pedal is pressed-
- Movement of Vehicle (Vehicle speed over 0)

### Service Check

If the DPF indicator change from illuminates to blink or Engine Check Lamp (MIL) illuminates with DPF indicator in spite of the procedure, Kia recommends to visit an authorised Kia dealer/service partner and then check the Diesel Catalyst and engine system including oil level inspection. Please note that the vehicle acceleration is limited to protect engine system when DPF indicator blinks or Engine Check Lamp (MIL) illuminates.

### Operating Self Regeneration Mode



If the self regeneration mode starts, the message "Regenerating filter..." and the remaining time appears. It takes around 30~60 minutes.

8

## Self Regeneration Mode Fail



The regeneration operation could be cancelled if the driver press the OK button firmly whilst operating the self regeneration process.



If the system still needs the self regeneration process after cancelling the operation, the warning message appears. (Diesel filter regeneration required.) If the driver press the OK button firmly, it can restart the self regeneration mode again. (The Self regeneration conditions should be satisfied.)



The self regeneration process stops if any of the self regeneration conditions is cancelled. If the self regeneration process is cancelled automatically, the system maintains "Self-regeneration stopped" message. If the driver press the OK button firmly, it can restart the self regeneration mode again. (Self regeneration conditions should be satisfied.)

## Selective Catalytic Reduction (if equipped)

The Selective Catalytic Reduction (SCR) system is to catalytically convert NOx to Nitrogen and Water by using the reduction agent, the urea solution.

### ⚠ WARNING

- It may be a criminal offence to use a vehicle that does not consume any urea solution.
- Use of, and refilling of, a required urea solution of the correct specifications is mandatory for the vehicle to comply with the certificate of conformity issued for that vehicle type.

### Urea solution level gauge (if equipped)



OSP21053141

The urea solution level gauge indicates the approximate amount of remaining urea solution inside the urea solution tank.

\* The urea level gauge image pops up, whenever the ENGINE START/STOP button is ON position.

### Low urea solution warning message (if equipped)



OSP21083048



OSP21083049





OSP21083050



OSP21083051

The lack warning messages of urea solution appear below urea solution level of approximately 5.4 L. When the warning message "Low urea" is displayed with SCR warning lamp (  ), the urea solution tank needs to be refilled. If not refilled for a considerable mileage, visual

warning system will escalate the intensity by displaying the message "Refill urea" with SCR warning lamp () .

In this case, the urea solution tank soon needs to be refilled. The remaining urea solution in the urea solution tank approaches to too low level the warning message "Refill urea in 000km or vehicle will not start" with SCR warning lamp () . "xxx km(mile)" represents the remaining travel distance allowed, so do not continue driving to the limit of the remaining travel distance without refilling.







Otherwise, the vehicle can't be restarted once the engine is turned off by the ENGINE START/STOP button. Based on the driving pattern, environmental condition and road profile, the deducted remaining mileage may differ from the actual travel distance. When "Low urea" or "Refill urea" message is displayed, a sufficient amount of urea solution must be added. When "Refill urea in 000km or vehicle will not start" message is displayed, refill a sufficient amount of urea solution.

When "Refill urea tank or vehicle will not start" message is displayed with SCR

warning lamp () , the vehicle can't be restarted once the engine is turned off by the ENGINE START/STOP button. For the above cases, full replenishment is always recommended.

Refer to "Recommended lubricants and capacities" on page 9-10.



Malfunction with the SCR system (if equipped)

	Upon detecting a malfunction	Driving 50 km after detecting a malfunction
Urea solution system failure (= no urea solution injection)	 <p>Diesel filter regeneration required. See owner's manual</p> <p>OSP21083045</p>	 <p>Service urea system in 000km. Otherwise vehicle will not start</p> <p>OSP21083055</p>
Incorrect urea solution detected (= abnormal urea solution)	 <p>Incorrect urea detected</p> <p>OSP21083053</p>	 <p>Refill correct urea in 000km. Otherwise vehicle will not start</p> <p>OSP21083052</p>
Abnormal urea-solution consumption (= post treatment failure)	 <p>Check urea system</p> <p>OSP21083054</p>	 <p>Service urea system in 000km. Otherwise vehicle will not start</p> <p>OSP21083055</p>

SCR system has malfunction due to disconnected electrical components, incorrect urea solution and so on.

"xxx km (mile)" represents the remaining travel distance allowed, so do not continue driving to the limit of the remaining travel distance without fixing the source of the malfunction. Otherwise, the vehicle can't be restarted once the engine is turned off by the ENGINE START/STOP button. In this case, have your vehicle inspected by a professional workshop. Kia recommends to contact an authorised Kia dealer/service partner.

## Clearing the vehicle-restarting restriction (if equipped)

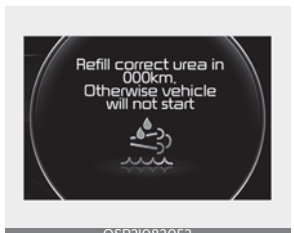
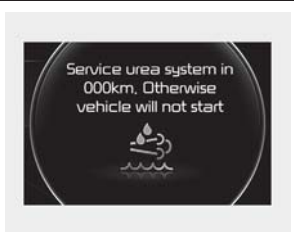
No restart	
Low urea solution level	 <p>OJF078268L</p>
Urea solution system failure (= no urea solution injection)	 <p>OSP2I083051</p>
Incorrect urea solution detected (= abnormal urea solution)	 <p>OSP2I083052</p>
Abnormal urea-solution consumption (= post treatment failure)	 <p>OSP2I083055</p>

Once the inducement system reached to final status and disabled the vehicle restart, it will only be deactivated in case the urea solution tank is replenished or the malfunctions have been rectified. If the vehicle can't be restarted with "Refill urea tank or vehicle will not start" message, refill a sufficient amount of urea solution, wait for minutes and try vehicle starting again. If vehicle starting is not possible regardless of urea solution level, have your vehicle inspected by a professional workshop. Kia recommends to contact an authorised Kia dealer/service partner.

## Adding urea solution

### To refill urea solution with a refill hose



1. Press the ENGINE START/STOP button to the OFF position.
2. Turn the urea solution tank cap in a counterclockwise direction to open it.
3. Fully insert the refill hose to add the ISO 22241-specified urea solution. Fill in a sufficient amount of urea solution.
  - \* Pay great caution not to add the urea solution into the fuel tank. If not, it surely applies adverse impact on the vehicle performance, causing various malfunctions.
  - \* Never use urea solution mixture with additives or water. It may allow foreign substances to enter the urea solution tank. If so, it surely applies adverse impact on the vehicle performance, causing various malfunctions.
  - \* Use only the ISO 22241-specified urea solution. Any unauthorised urea solution surely applies adverse impacts on the vehicle performance, causing various malfunctions.
4. Turn the urea solution tank cap in a clockwise direction to securely close it.

Refer to "Recommended lubricants and capacities" on page 9-10.

### To refill urea solution with a refill bottle

1. Press the ENGINE START/STOP button to the OFF position.
  2. Turn the urea solution tank cap in a counterclockwise direction to open it.
  3. Add the ISO 22241-specified urea solution. Fill in a sufficient amount of urea solution.
    - \* Pay great caution not to add the urea solution into the fuel tank. If not, it surely applies adverse impact on the vehicle performance, causing various malfunctions.
    - \* Pay great caution not to overfill the (completely) filled urea solution tank by force whilst refilling urea solution from a refill bottle. An over-filled urea solution tank will be expanded when it becomes frozen and this can cause a serious malfunction of the urea solution tank or urea solution system.
    - \* Never use urea solution mixture with additives or water. It may allow foreign substances to enter the urea solution tank. If so, it surely applies adverse impact on the vehicle performance, causing various malfunctions.
    - \* Use only the ISO 22241-specified urea solution. Any unauthorised urea solution surely applies adverse impacts on the vehicle performance, causing various malfunctions.
  4. Turn the urea solution tank cap in a clockwise direction to securely close it.
- Adding urea solution: Every approximately 5,600 km (The urea solution consumption is dependent on the road



profile, driving pattern and environmental condition)

\* It takes some time to update the cluster gauges after the urea solution injection.

### **⚠ WARNING**

- Do not apply any external impact on the DPF system. It may damage the catalyst, which is equipped inside the DPF system.
- Do not arbitrarily modify or manipulate the DPF system by redirecting or lengthen the exhaust pipe. It may adversely impact the DPF system.
- Avoid contact with drained water from the exhaust pipe. The water is slightly acid and harmful to skin. If contacted, thoroughly wash it.
- Any arbitrary manipulation or modification of the DPF system may cause a system malfunction. The DPF system is controlled by a complex electronic control unit.
- Wait for the DPF system to cool down before the maintenance service, as it is hot due to heat generation. Otherwise, it may cause a skin burn.
- Add only the specified urea solution, when your vehicle is equipped with the urea solution system.
- The urea solution system (i.e. urea solution nozzle, urea solution pump, and DCU) operates for approximately 2 minutes more to eliminate the remaining urea solution inside, even after the ENGINE START/STOP button is pressed to the OFF position. Before the maintenance service, make sure that the urea solution system is completely turned OFF.
- A urea solution of poor quality or any unauthorised liquids may damage the

vehicle components, including the DPF system. Any unverified additives in the urea solution may clog the SCR catalyst and cause other malfunctions, which require the expensive DPF system to be replaced.

- When urea solution comes in contact with the eyes or the skin, you should thoroughly wash the contaminated skin area.
  - When you swallow urea solution, thoroughly rinse your mouth and drink a lot of fresh water. Then, immediately consult a doctor.
  - When your cloth is contaminated with urea solution, immediately change your cloth.
  - When you have an allergic reaction to urea solution, immediately consult a doctor.
  - Make sure that urea solution is kept out of reach from children.
  - Wipe off any urea solution spillage with water or cloth. When urea solution is crystallised, wipe it off with a sponge or a cloth, which was dampened in cold water.
- When urea solution spillage is exposed in air for an extended period of time, it is crystallised in white, damaging the vehicle surface.
- Urea solution is not a fuel additive. Thus, it should not be injected to the fuel tank. Otherwise, it may damage the engine.
  - Urea solution is an aqueous solution, which is inflammable, non-toxic, colourless and odourless.
  - Store the urea solution tank only in well-ventilated locations. When urea solution is exposed to the hot temperature at approximately 50°C for an extended period of time (i.e. under

direct sunlight), the chemical decomposition may occur, emitting ammonia vapour.

### Storing urea solution (if equipped)

- It is improper to store urea solution in containers made of unsuitable materials like aluminium, copper alloy, non-alloyed still and galvanised steel. The urea solution dissolves metal materials, severely damaging the exhaust purification system to be non-repairable.
- Store urea solution only in containers made of the following materials.
  - DIN EN 10 088-1/-2/-3-specified CR-Ni steel, Mo-Cr-Ni steel, Polypropylene and Polyethylene

### Urea solution purity

- The following situations may damage the DPF system.
  - Fuels or any unauthorised liquids are added into the urea solution tank.
  - Additives are mixed with urea solution.
  - Water is added to dilute the urea solution.
- Use only the ISO 22241- or DIN70070-specified urea solution. When any unauthorised urea solution is added to the urea solution tank, have your vehicle inspected by a professional workshop. Kia recommends to contact an authorised Kia dealer/service partner.
- When any unauthorised impurities enter the urea solution tank, it may lead to the following problems.
  - Increased emission

- Malfunction with the DPF system
- Engine failure

Never add any used urea solution, which is drained from the urea solution tank (i.e. whilst maintaining the vehicle). Its purity cannot be guaranteed. Always add new urea solution.

<b>Specification of the standard urea solution</b>	Liquid such as diesel, petrol and alcohol shall never be used for SCR system. Any fluid other than recommended urea solution (conform to ISO22241 or DIN70070) can damage SCR system hardware and deteriorate vehicle emission.
--	---

### ⚠ WARNING

- When opening the urea solution tank cap at high outside temperatures, ammonia vapours may escape. Ammonia vapours have a pungent smell and primarily cause irritation of the:
  - Skin
  - Mucous membranes
  - Eyes

You may experience a burning sensation in your eyes, nose and throat, as well as coughing and watering of the eyes. Do not inhale ammonia vapours. Do not allow urea solution to come in direct contact with your skin. It is hazardous to your health. Wash any affected areas off with plenty of clean water. If necessary, consult a doctor.

- When handling with urea solution in closed space, ensure good ventilation. When the bottle of urea solution container is opened, pungent smelling fumes may escape.
- Keep urea solution out of reach of children.
- When urea solution overflows the vehicle surface, wash out the surface

- with clean water to prevent any corrosion.
- When replenishing, be careful lest the urea solution should overflow.
  - In case the vehicle was parked at very low ambient temperature (below -11 degree Celsius) for a long time, the urea solution will be frozen in the urea solution tank. With frozen urea solution, the urea solution tank level may not be detected correctly until the urea solution will be defrosted by activated heater. Incorrect urea solution or diluted urea solution can increase the freezing point, and thus defrosting may not be properly done by the heater which is activated below certain temperatures. This phenomenon may cause malfunction of the SCR system which can lead to the prohibition of engine restarting.
  - The time to defrost the urea solution varies in accordance with driving conditions and outside temperatures.
- If defective urea solution or liquid that is not recommended is supplied, there may be damage on the parts of the vehicle such as processing device. If defective fuel is used, foreign objects will be accumulated to SCR catalyst and cause catalyst pushed away or breaking.

### CAUTION

- If defective urea solution or unrecommended liquid is supplied, damage on car parts such as emission reduction devices can be caused. If defective fuel is added, foreign objects will be accumulated to SCR catalyst and cause it to get clogged and break. After adding incorrect urea solution, please visit the nearby authorised Kia dealer/service partner as early as possible.
- Liquid that are not recommended such as diesel, petrol, and alcohol shall never be used other than the recommended urea solution that satisfy ISO22241 or DIN70070.

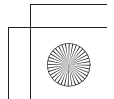
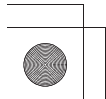
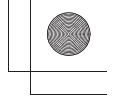
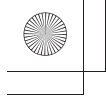

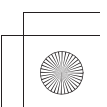
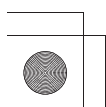
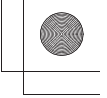
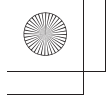

# Specifications & Consumer information **9**

Dimensions .....	9-2
Engine .....	9-3
Gross vehicle weight .....	9-4
Luggage volume .....	9-5
Air conditioning system.....	9-6
Bulb wattage .....	9-7
Tyres and wheels.....	9-9
Recommended lubricants and capacities .....	9-10
• Recommended SAE viscosity number.....	9-12
Vehicle Identification Number (VIN).....	9-13
Vehicle certification label.....	9-13
Tyre specification and pressure label.....	9-14
Engine number.....	9-14
Air conditioner compressor label .....	9-15
Refrigerant label.....	9-15
Declaration of conformity .....	9-16

## Specifications & Consumer information

### Dimensions

Item	mm (in)		
Overall length	4365 (171.9) / 4,375 (172.2)*		
Overall width	1,800 (70.9)		
Overall height	Without Roof rack	205/65R16	1,620 (63.8)
		215/60R17	1,630 (64.2)
	With Roof rack	205/65R16	1,635 (64.4)
		215/60R17	1,645 (64.8)
Tread	Front	205/65R16	1,572 (61.9)
		215/60R17	1,560 (61.4)
		215/55R18	1,560 (61.4)
	Rear	205/65R16	1,595 (62.8)
		215/60R17	1,583 (62.3)
		215/55R18	1,583 (62.3)
Wheelbase	2,610 (102.8)		

\*Anniversary Edition

## Engine

Item	Smartstream G1.5	(Diesel) 1.5 VGT	Smartstream G1.5 T-GDi
Displacement: cc (cu in)	1,497 (91.35)	1,493 (91.1)	1,482 (90.4)
Bore x Stroke: mm (in)	75.6 x 83.4	75 x 84.5	71.6 x 92 (2.8 x 3.6)
Firing order	1-3-4-2	1-3-4-2	1-3-4-2
No. of cylinders	4, In-Line	4, In-line	4 (inline)



## Gross vehicle weight

Item	Smartstream G1.5		(Diesel) 1.5 VGT		Smartstream G1.5 T-GDi	
	MT	IVT	iMT	AT	iMT	DCT
Gross vehicle weight kg (lbs.)	1,695(3,737 )	1,720(3,792 )	1,815(4,001 )	1,830(4,034 )	1,770(3,902 )	1,805(3,979 )

## Luggage volume

Item	Smartstream G1.5	(Diesel) 1.5 VGT	Smartstream G1.5 T-GDi
Luggage volume (VDA): L (cu ft)	Min: 433 L (15.29 cu ft)		
	Max: 1,401 L (49.48 cu ft)		

- Min: Behind rear seat to upper edge of the seat back.
- Max: Behind front seat to roof.

## Air conditioning system

Item	Weight of volume (g)	Classification
Refrigerant	530±25	R-134a
Compressor lubricant	110±10	FD46XG (IDEMITSU)

Please contact a professional workshop for more details.

Kia recommends to contact an authorised Kia dealer/service partner.

## Bulb wattage

Light Bulb		Wattage	Bulb type	
Front	Type A*	Low beam	60	Bulb
		High beam	60	Bulb
		Turn signal lamps	21	Bulb
		Position lamps	5	Bulb
		Daytime running lamps	21	Bulb
	Type B*	Low beam	60	Bulb
		High beam	60	Bulb
		Position lamp	LED	LED
		Day running lamp	LED	LED
		Turn signal lamps	21	Bulb
		Position lamp (centre)	LED	LED
	Type C & D*	Low beam	LED	LED
		High beam	LED	LED
		Position lamp	LED	LED
		Day running lamps	LED	LED
		Turn signal lamps	LED	LED
		Position lamp (centre)	1.2	LED
	Fog lamps (bulb)*		51	Bulb
	Fog lamps (LED)*		LED	LED
	Side repeater lamps		5	Bulb
Rear	Type A*	Tail lamps (inside)	5	Bulb
		Turn signal lamps	21	Bulb
		Stop lamps	21	Bulb
	Type B*	Tail lamps (inside)	LED	LED
		Tail lamps (outside)	LED	LED
		Turn signal lamps	21	Bulb
		Stop lamps (outside)	LED	LED
	Type C*	Tail lamps (inside)	LED	LED
		Tail lamps (outside)	LED	LED
		Turn signal lamps (out side)	LED	LED
		Stop lamps (out side)	LED	LED
		Turn signal lamps (inside)	LED	LED
	License plate lamps		5	Bulb
	High mounted stop lamps		30	Bulb
Back up Lamp		16	Bulb	

Specifications & Consumer information

Bulb wattage

	Light Bulb	Wattage	Bulb type
Interior	Map lamps (without sunroof)	8	Bulb
	Map lamps (with sunroof)	LED	LED
	Room lamps (without sunroof)	8	Bulb
	Personal lamps (with sunroof)	LED	LED
	Luggage lamp	10	Bulb

\*: if equipped

## Tyres and wheels

Item	Tyre size	Wheel size	Load capacity		Speed capacity		Inflation pressure [bar (psi, kPa)]				Wheel lug nut torque kgf·m (lbf·ft, N·m)
							Normal load		Maximum load		
			L <sup>1</sup>	kg	SS <sup>2</sup>	km/h	Front	Rear	Front	Rear	
Full size tyre (and spare tyre)	205/65R16	6.0Jx16 (steel) 6.0Jx16 (alloy)	95	690	H	210	2.4 (35/240)	2.4 (35/240)	2.4 (35/240)	2.4 (35/240)	11-13 (79-94, 107-127)
	215/60R17	6.5J x 17	96	710	H	210					
	215/55R18	6.5Jx18	95	690	H	210					

\*1. Load Index

\*2. Speed Symbol

### **⚠ CAUTION**

When replacing tyres, use the same size originally supplied with the vehicle. Using tyres of a different size can damage the related parts or make it work irregularly.

### **\* NOTICE**

- We recommend that when replacing tyres, use the same originally supplied with the vehicles.  
If not, that affects driving performance.
- When driving in high altitude grades, it is natural for the atmospheric pressure to decrease.  
Therefore, please check the tyre pressure and add more air when necessary.  
Additionally required tyre air pressure per km above sea level: 1.5 psi/km.



## Recommended lubricants and capacities

To help achieve proper engine and powertrain performance and durability, use only lubricants of the proper quality.

The correct lubricants also help promote engine efficiency that results in improved fuel economy.

These lubricants and fluids are recommended for use in your vehicle.

Lubricant		Volume (L)	Classification		
Engine oil (drain and refill)	Petrol	Smartstream G1.5	3.8	SAE 0W-20, API SN PLUS <sup>*1</sup>	
		Smartstream G1.5 T-GDi	4.2	SAE 0W-20, ACEA C5 <sup>*2</sup>	
	Diesel	(Diesel) 1.5 VGT	4.8	SAE 0W-20, ACEA C5	
Manual transmission (MT) fluid <sup>*3</sup>	Petrol	Smartstream G1.5	1.5~1.6	TGO-9 SAE 70W, API GL-4	
	Diesel	(Diesel) 1.5 VGT			
Dual clutch transmission (DCT) fluid <sup>*3</sup>	Petrol	Smartstream G1.5 T-GDi	1.6-1.7	TGO10 PLUS DCTF SAE 70W	
Automatic transmission (AT) fluid <sup>*3</sup>	Diesel	(Diesel) 1.5 VGT	7.1	ATF SP4-M1	
Intelligent variable transmission (IVT) fluid <sup>*5</sup>	Petrol	Smartstream G1.5	6.7	ATF SP-CVT1 <sup>*4</sup>	
Intelligent Manual transmission (iMT) fluid <sup>*3</sup>	Petrol	Smartstream G1.5 T-GDi	1.5~1.6	TGO-9 SAE 70W, API GL-4	
	Diesel	(Diesel) 1.5 VGT			
Intelligent manual transmission (iMT) system actuator fluid	Petrol	Smartstream G1.5 T-GDi	0.082	SAE J1704 DOT-4 LV, ISO4925 CLASS-6, FMVSS116 DOT-4, FMVSS116 DOT-3	
	Diesel	(Diesel) 1.5 VGT	0.087		
Coolant	Petrol	Smartstream G1.5	MT	6.4	An Phosphate based ethylene glycol based coolant
			IVT	6.1	
		Smartstream G1.5 T-GDi	iMT	6.5	
			DCT	6.5	
	Diesel	(Diesel) 1.5 VGT	iMT	7.2	
			AT	7.0	
Brake/clutch fluid		0.7	SAE J1704 DOT-4 LV, FMVSS 116 DOT-4, ISO4925 CLASS-6		
Urea solution		12	ISO22241		
Fuel		50	-		

\* 1. Refer to "Recommended SAE viscosity number" on page 9-12.

\*2. Requires <API SN PLUS/SP (or above) or ILSAC GF-6 Full synthetic> grade engine oil. If a lower grade engine oil (mineral oil including Semi-synthetic) is used, then the

engine oil and engine oil filter must be replaced as indicated severe maintenance condition.

\*3. Requires <API Latest (or ILSAC Latest) or ACEA C5/C2/C3 Full synthetic> grade engine oil. If a lower grade engine oil (mineral oil including Semi-synthetic) is used, then the engine oil and engine oil filter must be replaced as indicated severe maintenance condition.

\*4. To maintain your vehicle's best performance, use Kia genuine oil or those of an equivalent standard oil.



## Recommended SAE viscosity number

### **⚠ CAUTION**

Always be sure to clean the area around any filler plug, drain plug, or dipstick before checking or draining any lubricant. This is especially important in dusty or sandy areas and when the vehicle is used on unpaved roads. Cleaning the plug and dipstick areas will prevent dirt and grit from entering the engine and other mechanisms that could be damaged.

Engine oil viscosity (thickness) has an effect on fuel economy and cold weather operating (engine start and engine oil flowability). Lower viscosity engine oils can provide better fuel economy and cold weather performance, however, higher viscosity engine oils are required for satisfactory lubrication in hot weather.

Using oils of any viscosity other than those recommended could result in engine damage.

### **\* NOTICE**

Never add any additives to the engine oil. Engine oil additives can change the properties of engine oil and may cause serious engine failure.

When choosing an oil, consider the range of temperature your vehicle will be operated in before the next oil change. Proceed to select the recommended oil viscosity from the chart.

		Temperature Range for SAE Viscosity Numbers									
Temperature	°C	-30	-20	-10	0	10	20	30	40	50	
	°F	-10	0	20	40	60	80	100	120		
Smartstream G1.5 Smartstream G1.5 T-GDi		0W-20									
(Diesel) 1.5 VGT		15W-40									
		10W-30									
		5W-30									
		0W-30, 0W-20									

## Vehicle Identification Number (VIN)

The Vehicle Identification Number (VIN) is the number used in registering your vehicle and in all legal matters pertaining to its ownership, etc.

The number is punched on the floor under the driver or passenger front seat. To check the number, open the cover.

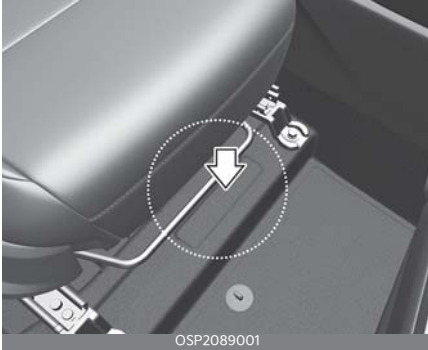

The VIN is also on a plate attached to the top of the dashboard. The number on the plate can easily be seen through the windscreen from outside.

VIN label (if equipped)



## Vehicle certification label

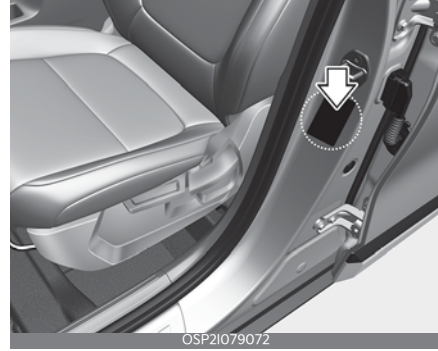

The vehicle certification label attached on the driver's (or front passenger's) side centre pillar gives the vehicle identification number (VIN).

## Tyre specification and pressure label

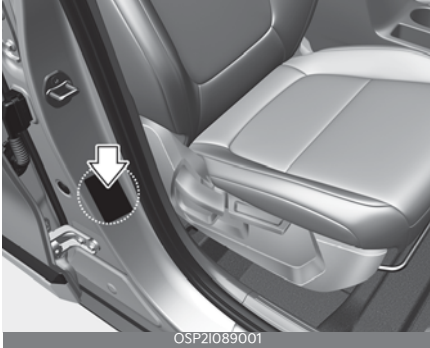

The tyres supplied on your new vehicle are chosen to provide the best performance for normal driving.

The tyre label located on the driver's side centre pillar gives the tyre pressures recommended for your vehicle.

## Engine number

The engine number is stamped on the engine block as shown in the drawing.

Smartstream G1.5



Smartstream G1.5 T-GDi

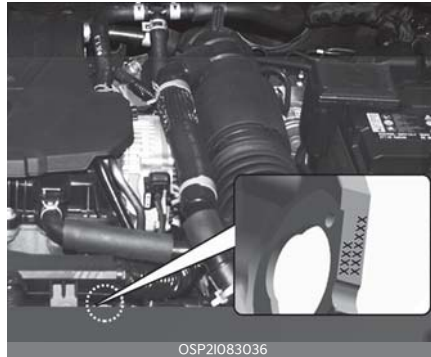

(Diesel) 1.5 VGT



### Air conditioner compressor label



A compressor label informs you the type of compressor your vehicle is equipped with such as model, supplier part number, production number, refrigerant (1) and refrigerant oil (2).

### Refrigerant label



The refrigerant label is located on the underside of the bonnet.

## Declaration of conformity

**CE CE 0678**

The radio frequency components of the vehicle comply with requirements and other relevant provisions of Directive 1995/5/EC.

Further information including the manufacturer's declaration of conformity is available on Kia web site as follows;  
<http://www.kia-hotline.com>

# Abbreviation **A**

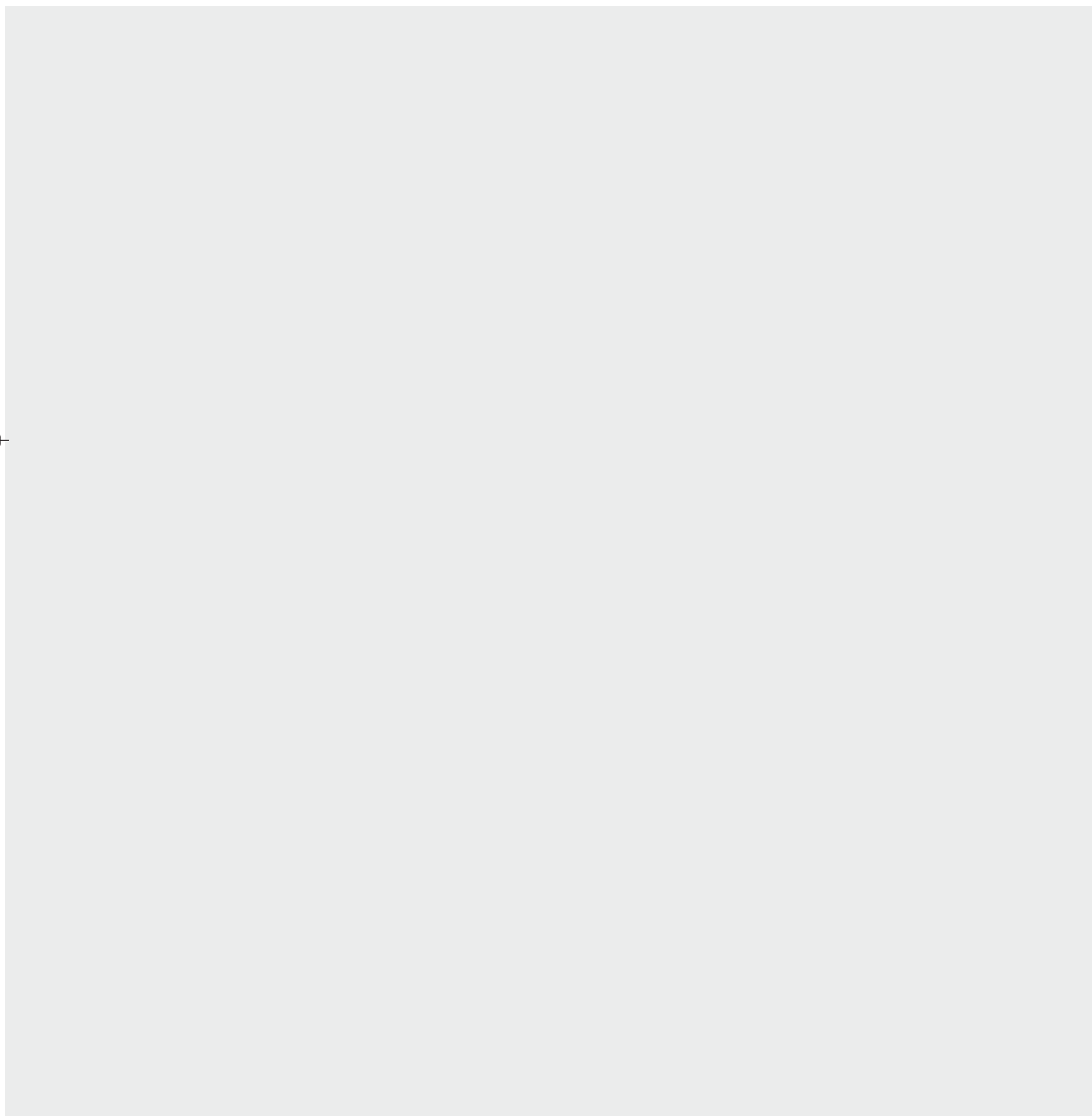

## Abbreviation

### Abbreviation

#### ABS

Anti-Lock Brake System

#### ACC

Accessory

#### AKI

Antiknock Index

#### AVN

Audio Video Navigation

#### BVM

Blind-Spot View Monitor

#### CC

Cruise Control

#### DPF

Diesel Particulate Filter

#### DRL

Daytime Running Light

#### DRVM

Driving Rear View Monitor

#### ECM

Electric Chromic Mirror

#### ESC

Electronic Stability Control

#### GVW

Gross Vehicle Weight

#### GVWR

Gross Vehicle Weight Rating

#### HAC

Hill-start Assist Control

#### HID

High-Intensity Discharge

#### HMSL

High Mounted Stop Lamp

#### HUD

Head-Up Display

#### IMT

Intelligent Manual Transmission

#### IVT

Intelligent Variable Transmission

#### LNT

Lean NOx Trap

#### MIL

Malfunction Indicator Lamp

#### ODO

Odometer

#### PCM

Powertrain Control Module

#### PCSV

Purge Control Solenoid Valve

#### PDW

Parking Distance Warning

#### RON

Research Octane Number

#### PPF

Petrol Particulate Filter

#### RPM

Revolution Per Minute

#### RVM

Rear View Monitor

**Abbreviation**

**SRS**

Supplemental Restraint System

**SVM**

Surround View Monitor

**TCI**

Turbo Charger Intercooler

**TCM**

Transmission Control Module

**TPMS**

Tyre Pressure Monitoring System

**VIN**

Vehicle Identification Number

**VGT**

Variable Geometry Turbocharger

**VSM**

Vehicle Stability Management

**Abbreviation**



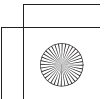
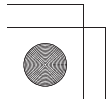
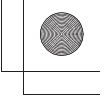
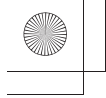

---

# Index I

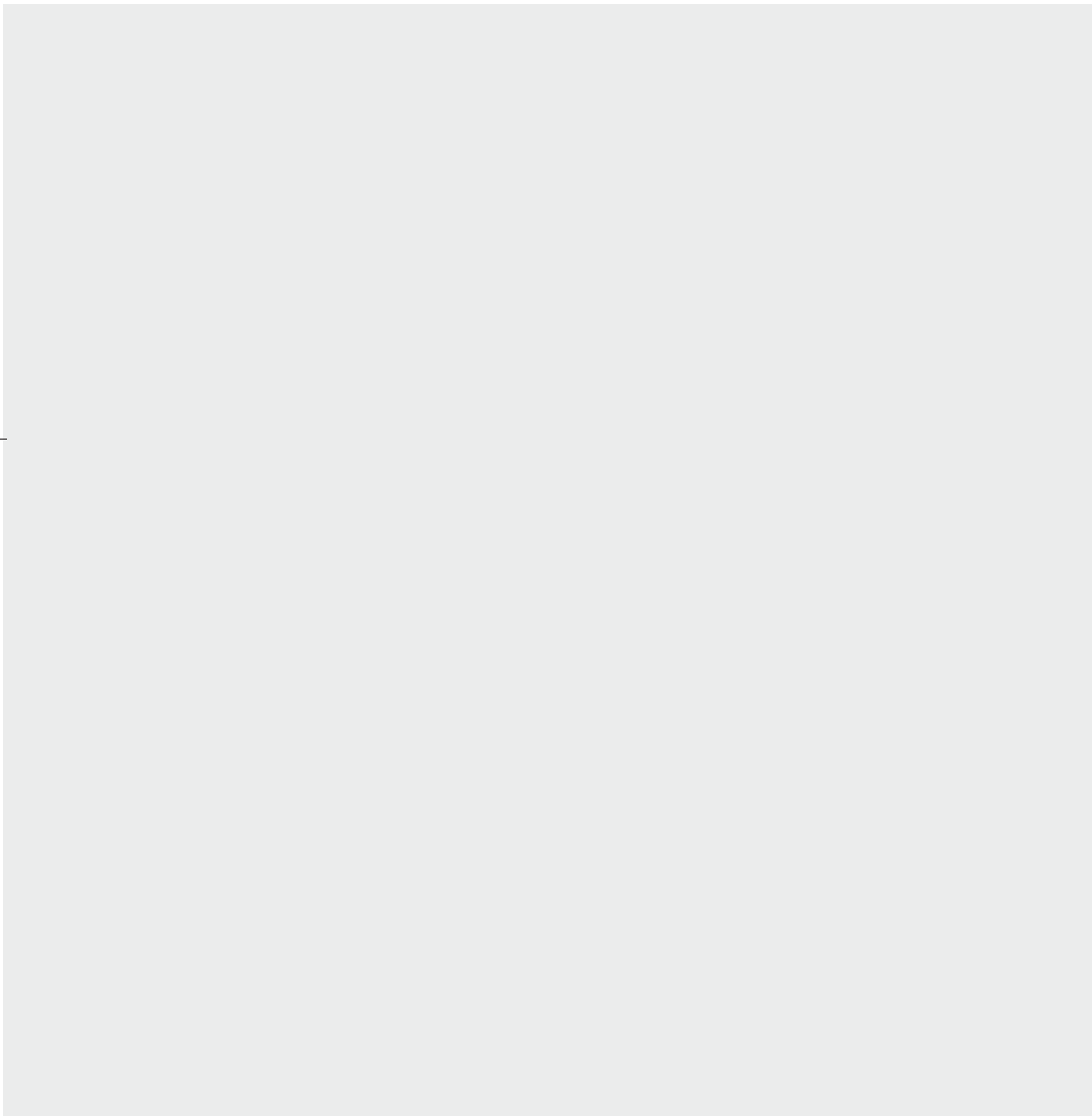

## Index

### A

<b>air bag</b>	3-37
air bag collision sensors	3-48
curtain air bag	3-46
driver's and passenger's front air bag	
inflation conditions	3-43
non-inflation conditions	3-49
side air bag	3-45
SRS care	3-52
SRS components and functions	3-40
warning and indicator	3-40
<b>air bag collision sensors</b>	3-48
<b>air bag warning label</b>	3-53
<b>air cleaner filter</b>	8-32
<b>air ventilation seat</b>	4-117
<b>ambient light</b>	4-115
<b>anti-lock brake system (ABS)</b>	5-48
<b>appearance care</b>	8-74
exterior care	8-74
interior care	8-78
<b>applying the parking brake</b>	5-41
<b>audio system</b>	
radio	4-127
USB port	4-126
<b>auto light</b>	4-79
<b>automatic climate control system</b>	4-101
air conditioning	4-109
controlling air intake	4-107
controlling fan speed	4-108
heating and air conditioning automatically	4-102
heating and air conditioning manually	4-104
mode selection	4-105
temperature control	4-106
turning off the front air climate control	4-109
<b>automatic transmission</b>	5-23
operation	5-23
shift lock system	5-27

<b>automatic transmission/ intelligent variable transmission shift indicator</b>	4-47
--	------

### B

<b>battery</b>	8-36
for best battery service	8-36
recharging the battery	8-38
reset items	8-39
<b>battery saver function</b>	4-78
<b>before driving</b>	5-3
<b>blind-spot collision-avoidance assist (BCA)</b>	6-24
blind-spot collision-avoidance assist malfunction	6-29
blind-spot collision-avoidance assist operation	6-27
blind-spot collision-avoidance assist settings	6-25
detecting sensor	6-25
limitations of blind-spot collision-avoidance assist	6-30
<b>blind-spot view monitor (BVM)</b>	6-46
operation	6-47
settings	6-47
<b>bonnet</b>	4-26
bonnet open warning	4-27
closing the bonnet	4-27
opening the bonnet	4-26
<b>bonnet open warning</b>	4-27
<b>brake fluid</b>	8-28
<b>brake system</b>	5-39
anti-lock brake system (ABS)	5-48
applying the parking brake	5-41
auto hold	5-46
electronic parking brake (EPB)	5-43
electronic stability control (ESC)	5-50
good braking practices	5-55
hill-start assist control (HAC)	5-54
parking brake	5-41
power brakes	5-39
releasing the parking brake	5-42
vehicle stability management (VSM)	5-53
<b>bulb replacement precaution</b>	8-60

---

## C

<b>care of seat belt</b>	3-25
<b>cargo area cover</b>	4-124
<b>centre console storage</b>	4-112
<b>check exhaust system</b>	5-3
<b>child restraint system (CRS)</b>	3-26
installing a CRS	3-28
types	3-27
<b>child-protector rear door lock</b>	4-19
<b>climate control air filter</b>	8-33
<b>climate control system</b>	4-92
air conditioning	4-92
air conditioning refrigerant label	4-94
checking the amount of air conditioner refrigerant and compressor lubricant	4-94
climate control air filter heating	4-92
system operation	4-92
ventilation	4-92
<b>closing the bonnet</b>	4-27
<b>clothes hanger</b>	4-122
<b>cruise control (CC)</b>	6-48
decreasing set speed	6-49
increasing set speed	6-49
resuming cruise control	6-50
setting set speed	6-48
temporarily pausing cruise control	6-50
turning off cruise control	6-50
<b>cup holder</b>	4-115
<b>curtain air bag</b>	3-46

---

## D

<b>day/night rearview mirror</b>	4-38
<b>daytime running light (DRL)</b>	4-78
<b>declaration of conformity</b>	6-98
the radio frequency components (front radar) complies	6-98
the radio frequency components (rear corner radar) complies	6-101
<b>defogging (windscreen)</b>	4-110
<b>defrosting (windscreen)</b>	4-110
<b>door lock</b>	4-16
child-protector rear door lock	4-19
from inside the vehicle	4-17
from outside the vehicle	4-16

<b>drive mode integrated control system</b>	5-61
traction control	5-62
<b>driver attention warning (DAW)</b>	6-40
detecting sensor	6-40
driver attention warning malfunction	6-43
driver attention warning operation	6-41
driver attention warning settings	6-41
leading vehicle departure alert	6-42
limitations of driver attention warning	6-44
<b>driver's and passenger's front air bag</b>	3-43
<b>driver's seat belt</b>	3-16
<b>driving assist mode</b>	4-51
<b>driving at night</b>	5-68
<b>driving in flooded areas</b>	5-68
<b>driving in the rain</b>	5-68
<b>driving on unpaved roads</b>	5-68
<b>dual clutch transmission</b>	5-29

---

## E

<b>economical operation</b>	5-65
<b>electric chromic mirror (ECM) with Kia Connect service</b>	4-38
<b>electronic stability control (ESC)</b>	5-50
<b>emergency commodity</b>	7-23
first aid kit	7-23
triangle reflector	7-23
<b>emergency starting</b>	7-5
jump starting	7-5
push-starting	7-6
<b>emergency towing</b>	7-20
<b>emission control system</b>	8-81
<b>engine compartment</b>	8-4
<b>engine coolant</b>	8-24
recommended coolant	8-24
<b>engine coolant temperature gauge</b>	4-44
<b>engine oil and filter (for petrol)</b>	8-19
<b>engine oil (for diesel)</b>	8-22
<b>engine overheats</b>	7-7
<b>engine start/stop button</b>	5-9

illuminated engine start/stop button position	5-9
starting the engine	5-12
starting the engine with smart key	5-12
<b>exterior features</b>	4-125
roof rack	4-125

## F

<b>floor mat anchor(s)</b>	4-123
<b>fog light (front)</b>	4-80
<b>forward collision-avoidance assist (FCA) (sensor fusion)</b>	6-4
detecting sensor	6-4
forward collision-avoidance assist operation	6-7
forward collision-avoidance assist settings	6-5
limitations of forward collision-avoidance assist	6-11
<b>forward/reverse parking distance warning (PDW)</b>	6-93
forward/reverse parking distance warning malfunction and precautions	6-96
forward/reverse parking distance warning operation	6-94
forward/reverse parking distance warning settings	6-94
<b>front seat adjustment for manual seat</b>	3-6
<b>front seat adjustment for power seat</b>	3-7
<b>front seat headrest</b>	3-8
<b>fuel filler door</b>	4-28
<b>fuel filter (for diesel)</b>	8-31
<b>fuel gauge</b>	4-45
<b>fuel requirements</b>	1-2
<b>fuses</b>	8-50
replacing engine compartment fuse	8-52
replacing inner panel fuse	8-52

## G

<b>gauges</b>	4-43
engine coolant temperature gauge	4-44
fuel gauge	4-45

odometer	4-45
outside temperature gauge	4-47
speedometer	4-43
tachometer	4-43
<b>glove box</b>	4-113
<b>good braking practices</b>	5-55

## H

<b>hazardous driving conditions</b>	5-66
<b>head light (low beam)</b>	4-79
<b>headlight (headlamp) escort function</b>	4-90
<b>headlight levelling device</b>	4-84
<b>headrest</b>	
front seat headrest	3-8
rear seat headrest	3-14
<b>head-up display (HUD)</b>	4-76
head up display information	4-77
head up display setting	4-77
<b>heating and air conditioning automatically</b>	4-102
<b>heating and air conditioning manually</b>	4-97, 4-104
<b>highway driving</b>	5-69
<b>hill-start assist control (HAC)</b>	5-54
<b>horn</b>	4-37

## I

<b>idle stop and go (ISG) system</b>	5-56
auto start	5-58
auto stop	5-57
ISG system indicator	5-59
operating conditions	5-58
<b>illuminated engine start/stop button</b>	5-9
<b>immobiliser system</b>	4-12
<b>indicator lights</b>	4-71
<b>infotainment system</b>	4-126
audio system	4-126
<b>infotainment system vehicle settings</b>	4-75
setting your vehicle	4-75
vehicle settings menu	4-76
<b>inside rearview mirror</b>	4-37
<b>installing a CRS</b>	3-28

<b>instrument cluster</b>	4-41
automatic transmission/intelligent variable transmission shift indicator	4-47
engine coolant temperature gauge	4-44
fuel gauge	4-45
gauges	4-43
manual transmission/intelligent manual transmission shift indicator	4-48
odometer	4-45
outside temperature gauge	4-47
speedometer	4-43
tachometer	4-43
transmission shift indicator	4-47
<b>intelligent manual transmission</b>	5-19
operation	5-20
transmission high temperature	5-21
transmission overheated	5-22
<b>intelligent manual transmission (iMT) system actuator fluid</b>	8-27
<b>intelligent variable transmission (IVT)</b>	5-35
operation	5-35
shift lock system	5-38
<b>interior features</b>	4-115
air ventilation seat	4-117
ambient light	4-115
ashtray	4-115
cargo area cover	4-124
clothes hanger	4-122
cup holder	4-115
floor mat anchor(s)	4-123
power outlet	4-118
side curtain	4-124
sliding armrest	4-116
sound mood lamp	4-115
sun visor	4-117
USB charger	4-119
wireless smart phone charging system	4-120
<b>interior light</b>	4-88
automatic turn off function	4-88
luggage room lamp	4-90
map lamp	4-88
room lamp	4-89

---

## J

<b>jump starting</b>	7-5
----------------------	-----

---

## K

<b>key operations</b>	4-7
battery replacement	4-6
folding key	4-7
smart key	4-8
<b>key positions</b>	5-5
ignition switch position	5-5
starting the engine	5-6
stopping the petrol engine/diesel engine (manual transmission/intelligent manual transmission (iMT))	5-9

---

## L

<b>lane following assist (LFA)</b>	6-66
detecting sensor	6-66
lane following assist malfunction	6-69
lane following assist operation	6-67
lane following assist settings	6-66
limitations of lane following assist	6-69
<b>lane keeping assist (LKA)</b>	6-17
detecting sensor	6-17
Lane Keeping Assist disabled	6-21
lane keeping assist malfunction	6-21
lane keeping assist operation	6-18
lane keeping assist settings	6-18
limitations of lane keeping assist	6-22
<b>LCD display</b>	4-49
LCD Display Control	4-49
LCD display messages	4-61
LCD display modes	4-50
user settings mode	4-52
<b>LCD display messages</b>	4-61
<b>LCD display modes</b>	4-50
driving assist mode	4-51
master warning mode	4-52
trip computer mode	4-51
turn by turn (TBT) mode	4-51
user settings mode	4-52
<b>LCD displays</b>	
service mode	4-60
trip information (trip computer)	4-57
<b>light bulbs</b>	
bulb replacement precaution	8-60
<b>lighting</b>	4-78
auto light	4-79
battery saver function	4-78

daytime running light (DRL)	4-78
head light (low beam)	4-79
headlight levelling device	4-84
high beam assist (HBA)	4-81
high beam assist malfunction and limitations	4-83
one-touch lane change	4-80
operating front fog light	4-80
operating high beam	4-79
operating turn signals	4-80
position and tail lamp	4-78
<b>lights bulbs</b>	8-60
headlamp bulb	8-64
replacing bulbs	8-64
<b>luggage board</b>	4-114
<b>luggage net holder</b>	4-114
<b>luggage room lamp</b>	4-90

## M

<b>maintenance services</b>	8-7
owner maintenance precautions	8-7
owner's responsibility	8-7
<b>manual climate control system</b>	4-96
air conditioning	4-100
controlling air intake	4-99
controlling fan speed	4-99
heating and air conditioning manually	4-97
mode selection	4-98
temperature control	4-98
<b>manual speed limit assist (MSLA)</b>	6-37
resuming manual speed limit assist	6-39
setting the speed limit	6-37
temporarily pausing manual speed limit assist	6-38
turning off manual speed limit assist	6-39
<b>manual transmission</b>	5-16
operation	5-16
<b>manual transmission/intelligent manual transmission shift indicator</b>	4-48
<b>map lamp</b>	4-88
<b>master warning mode</b>	4-52
<b>mirrors</b>	4-37
adjusting the outside rearview mirrors	4-39

day/night rearview mirror	4-38
electric chromic mirror (ECM) with Kia Connect service	4-38
folding the outside rearview mirror	4-40
inside rearview mirror	4-37
outside rearview mirror	4-38
<b>motor driven power steering (MDPS)</b>	4-35

## O

<b>odometer</b>	4-45
<b>one-touch lane change</b>	4-80
<b>opening the bonnet</b>	4-26
<b>operating high beam</b>	4-79
<b>outside rearview mirror</b>	4-38
<b>outside temperature gauge</b>	4-47
<b>owner maintenance</b>	8-8

## P

<b>panorama sunroof</b>	4-31
automatic reversal	4-32
power sunshade	4-31
resetting the sunroof	4-33
slide open/close	4-32
sunroof open warning	4-34
tilt open/close	4-32
<b>parking brake</b>	5-41
<b>passenger's seat belt</b>	3-17
<b>position and tail lamp</b>	4-78
<b>power brakes</b>	5-39
<b>power outlet</b>	4-118
<b>power window lock button</b>	4-25
<b>pre-tensioner seat belt</b>	3-20
<b>push-starting</b>	7-6

## R

<b>rear cross-traffic collision-avoidance assist (RCCA)</b>	6-80
detecting sensor	6-80
limitations of rear cross-traffic collision-avoidance assist	6-86
rear cross-traffic collision-avoidance assist malfunction	6-85

rear cross-traffic collision-avoidance assist operation	6-82	drive belts	8-15
rear cross-traffic collision-avoidance assist settings	6-80	drive shafts and boots	8-18
<b>rear defroster</b>	4-91	engine oil and filter	8-15
<b>rear seat adjustment</b>	3-11	exhaust pipe and muffler	8-18
<b>rear seat headrest</b>	3-14	fuel filter cartridge (for diesel)	8-15
<b>rear view monitor (RVM)</b>	6-70	fuel filter (for petrol)	8-15
rear view monitor malfunction and limitations	6-74	fuel lines, fuel hoses and connections	8-16
rear view monitor operation	6-71	intelligent variable transmission (IVT) fluid	8-17
rear view monitor settings	6-70	manual transmission fluid	8-17
<b>releasing the parking brake</b>	5-42	parking brake	8-18
<b>remote keyless entry</b>	4-8	spark plugs	8-16
remote keyless entry system operations	4-8	steering gear box, linkage and boots /lower arm ball joint	8-18
transmitter precautions	4-9	suspension mounting bolts	8-18
<b>reverse parking distance warning (PDW)</b>	6-89	vacuum crankcase ventilation hoses	8-16
reverse parking distance warning malfunction and precautions	6-91	vapour hose and fuel filler cap (for petrol engine)	8-16
reverse parking distance warning operation	6-90	<b>scheduled maintenance service</b>	8-10
reverse parking distance warning settings	6-90	maintenance under severe usage conditions	8-14
<b>risk of burns when parking or stopping vehicle</b>	1-5	normal maintenance schedule	8-11
<b>rocking the vehicle</b>	5-67	<b>seat</b>	3-3
<b>roof rack</b>	4-125	feature of seat leather	3-5
<b>room lamp</b>	4-89	front seat adjustment for manual seat	3-6
		front seat adjustment for power seat	3-7
		seat leather	3-5
		<b>seat belt</b>	3-15
		care of seat belt	3-25
		passenger's seat belt	3-17
		precautions	3-23
		pre-tensioner seat belt	3-20
		<b>seat belts</b>	
		driver's seat belt	3-16
		<b>seat leather</b>	3-5
		<b>seatback pocket</b>	3-10
		<b>service mode</b>	4-60
		<b>side air bag</b>	3-45
		<b>side curtain</b>	4-124
		<b>sliding armrest</b>	4-116
		<b>smart cruise control (SCC)</b>	6-52
		detecting sensor	6-52
		displaying operating status	6-57
		limitations of smart cruise control	6-61
		smart cruise control malfunction	6-61
		smart cruise control operation	6-53
		smart cruise control settings	6-52
		<b>smart key</b>	4-10
<hr/>			
<b>S</b>			
<b>safe exit warning (SEW)</b>	6-33		
detecting sensor	6-33		
malfunction and limitations	6-35		
operation	6-34		
settings	6-33		
<b>scheduled maintenance items</b>	8-15		
air cleaner filter	8-16		
air conditioning refrigerant	8-18		
automatic transmission fluid	8-17		
brake discs, pads and calipers	8-18		
brake fluid	8-18		
brake hoses and lines	8-18		
checking fluid levels	8-18		
coolant	8-17		
cooling system	8-17		





tyre traction	8-42
wheel alignment and tyres balance	8-41
wheel replacement	8-42
<b>tyres and wheels</b>	
all season tyres	8-47
tyre maintenance	8-43

---

## U

<b>USB charger</b>	4-119
<b>user settings mode</b>	4-52

---

## V

<b>vehicle break-in process</b>	1-5
<b>vehicle handling instructions</b>	1-6
<b>vehicle identification number (VIN)</b>	9-13
<b>vehicle modifications</b>	1-4
<b>vehicle stability management (VSM)</b>	5-53
<b>vehicle weight</b>	5-74
overloading	5-74

---

## W

<b>warning and indicator lights</b>	4-65
indicator lights	4-71
warning lights	4-65
<b>warning lights</b>	4-65
<b>washer fluid</b>	8-29
<b>welcome system</b>	4-90
headlight (headlamp) escort function	4-90
<b>what to do in an emergency</b>	7-3
if the engine will not start	7-4
if you have a flat tyre (with spare tyre)	7-12
in case of an emergency whilst driving	7-3
road warning	7-3
<b>window opening and closing</b>	4-23
<b>windows</b>	4-22
power window lock button	4-25
window opening and closing	4-23
<b>windscreen defrosting and defogging</b>	4-110
<b>winter driving</b>	5-70

<b>wiper blades</b>	8-34
blade inspection	8-34
replacing front windscreen wiper blade	8-35
replacing rear window wiper blade	8-35
<b>wipers and washers</b>	4-85
auto control	4-86
operating rear window wiper and washer switch	4-87
operating windscreen washer	4-87
<b>wireless smart phone charging system</b>	4-120

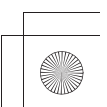
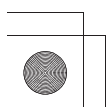
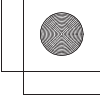
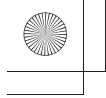

# Kia Warranty Policy **W**

<b>Kia New Vehicle Warranty .....</b>	<b>W-2</b>
<b>Replacement Parts Warranty .....</b>	<b>W-3</b>
<b>Emission Warranty .....</b>	<b>W-5</b>
<b>Kia Extended Warranty .....</b>	<b>W-8</b>
<b>Free Service Coupons .....</b>	<b>W-11</b>
<b>Maintenance Record Sheet .....</b>	<b>W-13</b>

## KIA WARRANTY POLICY

### Kia New Vehicle Warranty

Kia India Private Limited hereinafter called KIN, warrants that each new Kia vehicle sold shall be free from any defects in material and workmanship, under normal use and maintenance, subject to the following terms and conditions.

#### 1. Warranty Period

This warranty shall exist for a period of 36 months from the date of delivery to the first purchaser irrespective of the mileage. However, warranty for Kia vehicle being used for commercial purpose such as Taxi/Tourist operation is 36 months/100,000 kilometres from the date of delivery whichever is earlier. This warranty is transferable to subsequent owner for the remaining warranty period. This warranty is applicable only in India and not transferable to any other country.

#### 2. What is covered

Except as provided in paragraph 3 hereof, our Authorized Dealers shall either repair or replace, any Kia genuine part that is acknowledged by KIN to be defective in material or workmanship within the warranty period stipulated above, at no cost to the owner of the Kia vehicle for parts or labour. Such defective parts which have been replaced will become the property of KIN.

#### 3. What is not covered

This warranty shall not apply to:

Normal maintenance services, including without limitation, cleaning and polishing, minor adjustments, engine tuning, oil/fluid changes, filters replenishment, fastener retightening, wheel balancing, wheel alignment and tyre rotation etc.

Replacement of parts as a result of normal wear and tear such as spark plugs, belts, brake pads and linings, clutch disc/facing, filters, wiper blades, bulbs, fuses, etc.

Damage or failure resulting from:

Negligence of proper maintenance as required in this Owner's Manual and Service Booklet.

Misuse, abuse, accident, theft, flooding or fire.

Use of improper or insufficient fuel, fluids or lubricants.

Use of parts other than Kia Genuine Parts.

Any device and/or accessories not supplied by KIN.

Modifications, alterations, tampering or improper repair.

Parts used in applications of which they were not designed or not approved by KIN.

Slight irregularities not recognised as affecting quality or function of the vehicle or parts, such as slight noise or vibrations, or items considered characteristic of the vehicle.

Airborne fallout, Industrial fallout, acid rain, hail and windstorms, or other Acts of God.

Paint scratches, dents or similar paint or body damage.

Action of road elements (sand, gravel, dust or road debris) which results in stone chipping of paint or glass.

Incidental or consequential damages, including without limitation, loss of time, inconvenience, loss of use of vehicle or commercial loss.

**\* NOTICE**

Audio, Video, Navigation & Telematics (AVNT) system, Air Purifier system, Batteries, Tyres and Audio Systems, originally equipped on Kia vehicles are warranted directly by the respective manufacturers and not by KIN.

This warranty is the entire warranty given by KIN for Kia vehicles and no dealer or its or his agent or employee is authorized to extend or enlarge this warranty and no dealer or its or his agent or employee is authorized to make any oral warranty on KIN's behalf. KIN reserves the right to make any change in design or make any improvement on the vehicle at any time without any obligation to make the same change on vehicles previously sold. KIN reserves the right for the final decision in all warranty matters.



W

**Owner's Responsibilities**

Proper use, maintenance and care of vehicle in accordance with the instructions contained in this Owner's Manual and Service Booklet. If the vehicle is subject to severe usage conditions, such as operation in extremely dusty, rough, more repeated short distance driving or heavy city traffic during hot weather, maintenance of vehicle should be done more frequently as mentioned in this Owner's Manual and Service Booklet.

Retention of maintenance service records. It may be necessary for the customer to show that the required maintenance has been performed, as specified in this Owner's Manual and Service Booklet.

Delivery of the vehicle during regular service business hours to any authorized Kia Dealer to obtain warranty service.

In order to maintain the validity of this Basic Warranty, the vehicle must be serviced by Kia Authorized workshop in accordance to the Owner's Manual and Service Booklet.

## Replacement Parts Warranty

Kia India Private Limited hereinafter called KIN, warrants that each new Kia Genuine replacement part purchased from and installed by Kia Authorized Dealer shall be free from any defects in material or workmanship, under normal use and maintenance, subject to the following terms and conditions.

### 1. Warranty period

This warranty shall exist for a period of 6 months or until the vehicle has been driven for a distance of 10,000 Kilometres from the date of installation of replacement part by Kia Authorized Dealer, whichever occurs first.

### 2. What is covered

Except as provided in paragraph 3 hereof, our Authorized Dealers shall either repair or replace, any Kia genuine part that is acknowledged by KIN to be defective in material or workmanship within the warranty period stipulated above, after examinations carried out to confirm that none of the original settings have been tampered with, at no cost to the owner of the Kia vehicle for parts or labour. Such defective parts which have been replaced will become the property of KIN.

### 3. What is not covered

This warranty shall not apply to:

Normal maintenance services of parts such as cleaning, adjustment or replacement (i.e. spark plugs that are oil fouled, lead fouled, or which fail due to the use of low grade fuel).

Parts that fail due to abuse, misuse, neglect, alteration or accident or which have been improperly lubricated or repaired. Parts used in applications for which they were not designed or approved by KIN.

Failure due to normal wear of parts.

Direct or indirect failures caused by misuse and improper maintenance of vehicle.

Any vehicle on which the odometer reading has been altered so that mileage cannot be accurately determined.

Incidental or consequential damages, including without limitation, loss of time, inconvenience, loss of use of vehicle or commercial loss.

This warranty is the entire warranty given by KIN for Kia replacement parts and no dealer or its or his agent or employee is authorized to extend or enlarge this warranty and no dealer or its or his agent or employee is authorized to make any oral warranty on KIN's behalf. KIN

reserves the right for the final decision in all warranty matters.

#### Owner's Responsibility :

Proper use, maintenance and care of the vehicle in accordance with the instructions contained in the Owner's Manual and Service Booklet.

Retention of maintenance service records. It may be necessary for the customer to show that the required maintenance has been performed, as specified in this Owner's Manual and Service Booklet.

Retention of the customer's copy of the original repair order and its invoice/bill against which the part was replaced.

Delivery of the vehicle during regular service business hours to the same Kia Authorized Dealer who had sold and installed the replacement part.

In order to maintain the validity of this Parts replacement Warranty, the vehicle must be serviced by Kia Authorized workshop in accordance to the Owner's Manual and Service Booklet.

W



## Emission Warranty

KIN extends the Mass Emission standards (BSVI) for all its vehicle across all the states and union territories in India. Such cities would be automatically covered subject to other terms of the warranty policy and the conditions and obligations laid down hereunder. Kia India Private Limited hereinafter called KIN, certifies that the components liable to affect the emission of the gaseous pollutants in the vehicle in normal use despite the use to which it may be subjected, comply with the provisions of Rule 115(2) of the Central Motor Vehicle Rules, 1989 hereinafter referred to as the In-use emission standard, and further warrants that if on examination by a dealer duly authorized by KIN, the vehicle is discovered to be failing to meet the In-use emission standard as specified in the said rule, our Authorized Dealer shall take such corrective measures as may be necessary and shall at its sole discretion either repair or replace free of charge, such components of emission control system as are specified in paragraph 3 hereof.

### 1. Warranty period

This warranty will be in addition to and run parallel to the New Vehicle Warranty and shall exist for a period of 36 months from the date of delivery to the first purchaser, irrespective of the mileage. This warranty is transferable to subsequent owner for the remaining warranty period.

### 2. What is covered

Our Authorized Dealers shall either repair or replace, any Kia genuine part listed in paragraph 3 hereof, except as mentioned in paragraph 4 hereof, that is acknowledged by KIN to be defective in material or workmanship within the warranty period stipulated above, after examinations carried out to confirm that none of the original settings have been tampered with, at no cost to the owner of the Kia vehicle for parts or labour. Such defective parts which have been replaced will become the property of KIN.

### 3. Emission Warranty Parts List

1. Engine Control Module System
  - Engine Control Module
  - Crankshaft Position Sensor
  - Camshaft Position Sensor,
  - Throttle Position Sensor, MAP Sensor, O2 Sensor, IAT & ECT Sensor.
  - Vehicle Speed Signal
  - Brake Switch Signal
  - Mass Air Flow Sensor (MAFS)
2. Fuel Metering System
  - Fuel injectors
  - Fuel Pumps
  - Rail Pressure Sensor
3. Air Induction System
  - Air Cleaner Housing Assembly
  - Throttle Body
  - Intake Manifold
  - Accelerator Position Sensor
  - Boost Pressure Sensor
  - Knock Sensor
  - Turbocharger
  - Intercooler
4. Ignition System
  - H.T. Cable Set
  - Ignition Coil
  - Power Transistor
5. Evaporative Emission Control System
  - Vapour Storage Canister
  - Fuel Tank
  - Fuel Filler Tube and Fuel filler Cap
  - Fuel Tank Air Filter
  - Purge Control Solenoid Valve
  - Canister Close Valve
6. PCV System
  - PCV Valve
  - PCV Hoses
  - Oil Filler Cap
7. Catalytic Converter System
  - Exhaust Manifold
  - Exhaust Pipe Assembly
  - Catalytic Converter

8. Exhaust Gas Recirculation (EGR) System (Diesel Engines)
  - EGR Control System

9. LNT, SPDF, SCR system
  - Urea sensors
  - Urea injector
  - Urea pump & tank
  - Differential sensor
  - Temperature sensors

10. Miscellaneous items used in above Systems
  - Vacuum hoses, clamps, fittings, tubing or mounting hardware used with the above systems.
  - Valves, Switches and Solenoids

### 4. What is not covered

This warranty shall not apply to:

- Normal maintenance services including without limitation, engine tuning, oil/fluid changes, filters replenishment, etc.
- Replacement of parts as a result of normal wear and tear such as spark plugs, filters, etc.
- The vehicle reported without valid 'Pollution Under Control' certificate for the period immediately preceding the test during which the failure is discovered.
- The vehicle which has been run on adulterated fuel or lubricant or fuel/lubricants other than those specified by KIN.

Damage or failure resulting from:

- Negligence of proper maintenance as required in this Owner's Manual and Service Booklet.
- Misuse, abuse, accident, theft, flooding or fire.
- Use of improper or insufficient fuel, fluids or lubricants.

W

Any repair carried out other than by Kia Authorized Dealer/ Service Centre. Use of parts other than Kia Genuine Parts.

Any device and/or accessories not supplied by KIN.

Modifications, alterations, tampering or improper repair. not supplied by KIN.

Parts used in applications for which they were not designed or not approved by KIN.

Any penalties that may be charged by statutory authorities on account of failure to comply with the In-use emission standards.

The vehicle in which the odometer has been tampered with, changed or been disconnected.

Any consequential repairs or replacement of parts which maybe found necessary to establish compliance to In-use emission standards, in addition to the replacement of the components covered under Emission Warranty, will not be made free of cost unless such parts are also found to be in warrantable condition within the scope and limit of the New Vehicle Warranty.

Incidental or consequential damages, including without limitation, loss of time, inconvenience, loss of use of vehicle or commercial loss.

This warranty is the entire warranty given by KIN for Kia vehicles and no dealer or its or his agent or employee is authorized to extend or enlarge this warranty and no dealer or its or his agent or employee is authorized to make any oral warranty on KIN s behalf.

KIN reserves the right to make any change in design or make any improvement on the vehicle at any time without any obligation to make the same change on vehicles previously sold.

#### **Owner's Responsibility:**

Proper use, maintenance and care of the vehicle in accordance with the instructions contained in the Owner's Manual and Service Booklet. If the vehicle is subject to severe usage conditions, such as operation in extremely dusty, rough, more repeated short distance driving or heavy city traffic during hot weather, maintenance of vehicle should be done more frequently as mentioned in this Owner's Manual and Service Booklet.

In order to maintain the validity of this Emission Warranty, the vehicle must be serviced by Kia Authorized Dealer or Service Centre in accordance to the Owner s Manual and Service Booklet.

Retention of maintenance service records. It may be necessary for the customer to show that the required maintenance has been performed, as specified in this Owner's Manual and Service Booklet.

Immediate Delivery of the vehicle to any authorized Kia Dealer upon discovery of failure to comply with the In-use emission standard in spite of proper use, maintenance and care of vehicle in accordance with the instructions contained in this Owner's Manual and Service Booklet.

Production of Pollution Under Control (PUC) certificate valid for the period immediately preceding the test during which the failure is discovered, the test having been carried out either for obtaining a new certificate, or pursuant upon being directed by an officer as referred to in sub-rule (2) of Rule 116 of the Central Motor Vehicles Rules.

**\* NOTICE**

**Kia Extended Warranty\***

KIA offers optional paid extended warranty on selected models, in addition to the basic new vehicle warranty. For more details on Kia Extended Warranty please call the nearest dealer or our toll free number 1800-108-5000.



\* Conditions apply

## Audio Warranty (if equipped)

The audio unit (Audio / Audio Video / Audio Video Navigation & Telematics [AVNT]) originally equipped on your vehicle is directly warranted by the audio unit manufacturer.

The warranty period as per the audio unit originally fitted on your vehicle is as per table:

System	Manufacturer	Warranty Term
<ul style="list-style-type: none"> <li>• Audio</li> <li>• Audio, Video (AV)</li> <li>• Audio, Video, Navigation &amp; Telematics (AVNT)</li> </ul>	Mobis India	2 years / 50,000 km (whichever is earlier)

\* Extended warranty is not available on Audio / AV / AVNT unit.

\* Table represents the warranty term prevalent at the time of printing of this manual and may vary as per the then term provided by the manufacturer.

\* For additional information you may contact a Kia authorized dealer or call our toll-free number 1800-108-5000

## 12 V Battery Warranty

Item	Source	Manufacturer	Warranty Claim	Warranty Period
12V Battery	Imported*	Delkor / Clarios / Solite etc.	Kia India	1 Year / Unlimited kms (From the date of New Vehicle Delivery)
	Local (Domestic)	Exide / Amaron etc.	Battery Supplier	As per Supplier Policy

\* In case of replacement of imported battery through warranty, the battery shall be replaced with any other battery of similar make and specifications.

\* Extended warranty is not available on either imported or domestic batteries.

\* Table represents the current warranty term and may vary as per the manufacturer.

**1st FREE SERVICE COUPON**

(800 – 1,000km or within 1.5 months of delivery, whichever is earlier)

**Customer Copy**

Model Name \_\_\_\_\_  
Customer's Name \_\_\_\_\_  
VIN \_\_\_\_\_  
Registration No. \_\_\_\_\_  
Mileage \_\_\_\_\_  
Delivery Date \_\_\_\_\_  
Service Date \_\_\_\_\_  
RO Number \_\_\_\_\_  
Dealer code \_\_\_\_\_

Movement that inspires

**Servicing Dealer's Stamp**

Service Mgr's Signature \_\_\_\_\_

**2nd FREE SERVICE COUPON**

(9,000 – 10,000km or within 12 months of delivery, whichever is earlier)

**Customer Copy**

Model Name \_\_\_\_\_  
Customer's Name \_\_\_\_\_  
VIN \_\_\_\_\_  
Registration No. \_\_\_\_\_  
Mileage \_\_\_\_\_  
Delivery Date \_\_\_\_\_  
Service Date \_\_\_\_\_  
RO Number \_\_\_\_\_  
Dealer code \_\_\_\_\_

Movement that inspires

**Servicing Dealer's Stamp**

Service Mgr's Signature \_\_\_\_\_

**3rd FREE SERVICE COUPON**

(19,000 – 20,000km or within 24 months of delivery, whichever is earlier)

**Customer Copy**

Model Name \_\_\_\_\_  
Customer's Name \_\_\_\_\_  
VIN \_\_\_\_\_  
Registration No. \_\_\_\_\_  
Mileage \_\_\_\_\_  
Delivery Date \_\_\_\_\_  
Service Date \_\_\_\_\_  
RO Number \_\_\_\_\_  
Dealer code \_\_\_\_\_

Movement that inspires

**Servicing Dealer's Stamp**

Service Mgr's Signature \_\_\_\_\_

Free Service Coupons are valid at all Kia authorized dealerships and workshops across India.

**Kia Warranty Policy**

**Emission Warranty**

Checklist for Free Service 1,000 KM -20,000 KM				
Number of months or driving distance, whichever comes first				
Months		1.5	12	24
Km X 1,000		1	10	20
Engine oil and engine oil filter*	Petrol, Diesel	I	R*	R*
Drive belts (Engine)	Petrol	-	-	I
Vacuum hoses and crankcase ventilation hoses	Petrol, Diesel	-	I	I
Drive shaft and boots	Petrol, Diesel	I	I	I
Fuel lines, hoses and connections	Petrol, Diesel	I	I	I
Intercooler, in/out hose, air intake hose	Smartstream G1.5T-GDi	-	I	I
Fuel filter	Petrol	-	-	I
Air cleaner filter*	Petrol, Diesel	-	I	R*
Exhaust system (leakages & damages)	Petrol, Diesel	I	I	I
Cooling system (water pump, hoses) & leakages	Petrol, Diesel	I	I	I
Air conditioner compressor/refrigerant (if equipped)	Petrol, Diesel	-	I	I
Climate control air filter (if equipped)*	Petrol, Diesel	-	I	R*
Brake discs, pads and calipers	Petrol, Diesel	-	I	I
Brake lines, hoses and connections	Petrol, Diesel	I	I	I
Brake/clutch fluid	Petrol, Diesel	I	I	I
Parking brake	Petrol, Diesel	I	I	I
Steering gear rack, linkage and boots	Petrol, Diesel	I	I	I
Suspension ball joints	Petrol, Diesel	I	I	I
Tire (pressure & tread wear)	Petrol, Diesel	I	I	I
Battery (12V) condition	Petrol, Diesel	I	-	I
Urea solution line & connections	Diesel	-	-	I
Urea solution filler cap	Diesel	-	-	I
Brake pedal, clutch pedal	Petrol, Diesel	I	I	I
iMT system Clutch actuator fluid (if equipped)*	Petrol, Diesel	-	I	R*
iMT system clutch tube and line (if equipped)	Petrol, Diesel	-	I	I
Wheel alignment & balancing*	Petrol, Diesel	-	-	I
Bolt and nuts on chasis and body	Petrol, Diesel	I	I	I
Lubricate locks & hinges	Petrol, Diesel	I	I	I
All electrical systems	Petrol, Diesel	I	I	I
Warning lights operation & KDS system check	Petrol, Diesel	I	I	I
Road test	Petrol, Diesel	Inspect if required		

I: Inspect and if necessary, adjust, correct, clean or replace R: Replace or change

**Notice**

\* All consumables on chargeable basis

# On chargeable basis

### MAINTENANCE RECORD SHEET

Repair category - Free Ser./Paid Serv./Running Repair/AC Repair

Repair Date	RO No.	Kms	Repair Category	Details of Repair done	Name of Servicing dealer	Ser. Adv. Sign.	Tech. sign.



### MAINTENANCE RECORD SHEET

Repair category - Free Ser./Paid Serv./Running Repair/AC Repair

Repair Date	RO No.	Kms	Repair Category	Details of Repair done	Name of Servicing dealer	Ser. Adv. Sign.	Tech. sign.

## KIA ROAD-SIDE ASSISTANCE PROGRAM



Kia Roadside Assistance is a 24 X 7 emergency support provided in any event of breakdown or road accident of your Kia vehicle

### Program benefits

Events	Key Benefits
Breakdown/Accident	Onsite Repair/ Vehicle recovery in case of breakdown / Road accident
Flat tire	Replacement of Flat tire with the spare tire available in the vehicle/ Tire puncture repair assist from nearby repairer
Dead battery	Jump Start
Key related	In-vehicle locked keys retrieval / Lost keys & broken key assist*
Fuel related	Fuel delivery in case of "Out of fuel" / Incorrect fuel & Contaminated Fuel Assist (Once a year upto 5 liter then it will be chargeable)
Taxi arrangement (for breakdown & accident)	Taxi arrangement for up to 100 KM from breakdown location

\*Duplicate key retrieval within city limits. If key is outside city limits vehicle will be towed to nearest Kia authorized dealership

## How to request assistance



In the event of a breakdown or accident, simply call Kia Care Roadside Assistance on the toll free number 1800 108 5000. This number can also be found on the above shown sticker, which is pasted on the vehicle. Then follow the below steps to get assistance:

1. Identify your vehicle with the VIN (Chassis Number), that is available on registration certificate (or smart card) or insurance document. You can also find the VIN on the vehicle (for details please refer page 6-10 under "Specifications & Consumer Information" chapter.
2. Explain the location of your vehicle (along with nearby landmark)
3. Explain the problem you are facing with the vehicle
4. Our customer care will advise you on further course of action

### Note:

- For your safety, park the vehicle on the edge of the road and turn on the warning lights
- In case you are on a highway, place the caution sign (warning triangle) provided with your vehicle approximately 3 meters (9 feet) from the vehicle facing towards the on-coming traffic

### Terms and conditions:

1. The service is applicable for the basic warranty period of the vehicle.
2. The 24 X 7 Road side assistance is available up to a nearest Kia authorized dealer workshop.
3. The vehicle recovery and/or taxi arrangement service\* is applicable for a condition in which the vehicle has been immobilized.
4. Towing of vehicle subject to vehicle being parked in a location where towing vehicle can tow and all tires being rolling and in straight position, else the side glass may be broken to tow the vehicle, where the cost of repairing the glass will be borne by customer.
5. Cost of parts replacement is not included, unless covered under Kia Warranty.
6. Cost of repairs made to your vehicle is not included, unless it is covered under Kia Warranty.
7. Assistance to be provided as long as Vehicle has broken down on a motorable gazetted, concrete or bitumen road, If vehicle goes off-road or fallen in pit/ditch/valley, cost of special equipment for retrieving vehicle from pit/ditch/valley will be covered but any consequential damage would be customer's liability. Any approvals for towing, in such cases, from local authorities has to be obtained by customer.
8. The Customer acknowledges and authorise RSA Services or its representative to tow the Vehicle for dropping off purposes to nearest authorised service centre, for repairs or Service at the sole risk, responsibility and liability of the Customer. The customer further agrees that in case of damage due to any accident while availing RSA services, required repairs shall be carried out at customer cost or under the valid insurance of the vehicle.
9. Vehicle will not be towed in case of involvement of police.

\*Conditions Apply for Taxi Services